

Panasonic

ideas for life

NARROW-PITCH CONNECTORS FOR PC BOARDS

NARROW-PITCH (0.8mm) CONNECTORS P8 SERIES

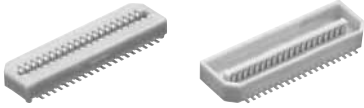

Socket

Header

Compliance with RoHS Directive

FEATURES

- 1. The product lineup consists of the low profile of 3.0 mm, 3.5 mm, 4.0 mm, 4.5 mm, 5.0 mm, 5.5 mm, 6.0 mm, 7.0 mm, 8.0 mm, 11.5 mm, and 13.0 mm 14.0 mm.
- 2. For the 11.5-mm type, the socket and header have the same shape. This simplifies management of stock and delivering.

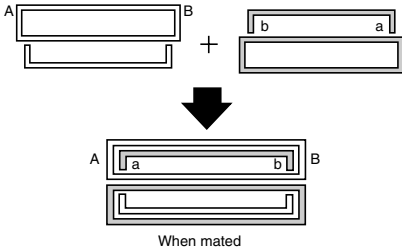

3. Perfect for portable devices, the bellows-type contacts provide a strong resistance against falling, impacts, and forced insertions and removals.

Bellows-type contacts

Bellows-type contacts resist mating stress and offer high contact reliability.

Ex.: Stacking height of 3.0 mm

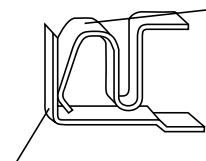

The bellows type contacts are fabricated by bending thin sheet metal. They offer reliable contact since a rounded corner, instead of a sharp edge, is used for tuning fork type contact.

Round corner makes contact.

4. Porosity treatment applied for improved resistance against corrosion.

5. Simple lock mechanism

Lock mechanism ensures proper contact and provides resistance against vibrations and shocks.

3.0 mm, 3.5 mm, 4.0 mm, 4.5 mm, 5.0 mm, 5.5 mm, 6.0 mm, 7.0 mm, 8.0 mm, 13.0 mm, and 14.0 mm.

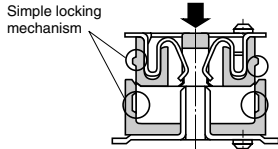

The simple lock mechanism is not featured on the 11.5-mm type. However, proper contact and resistance against vibrations and shocks are both ensured by the long mating length.

6. Automatic mounting (excluding 11.5 mm type)

1) Automatic mounting machine is available with an exclusive mounting nozzle.

Using the following types of suction nozzles make the connectors compatible with automatic mounting without the need for suction tape.

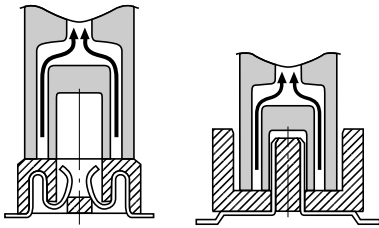

Suction tape and covers are also available for compatibility with other types of mounting machines.

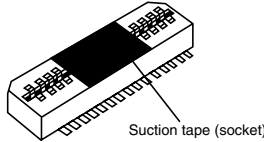

Suction tape (socket)

2) Positioning bosses (those without bosses are also available)

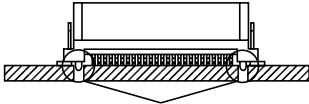

Bosses for positioning on the PC board (those without bosses are also available). Suitable for both manual and automatic mounting.

APPLICATIONS

Small portable equipment, laptop computers, video equipment, radio communication, cellular telephones, etc.

AXN(1/3/4)

ORDERING INFORMATION

1. P8 (11.5 mm)

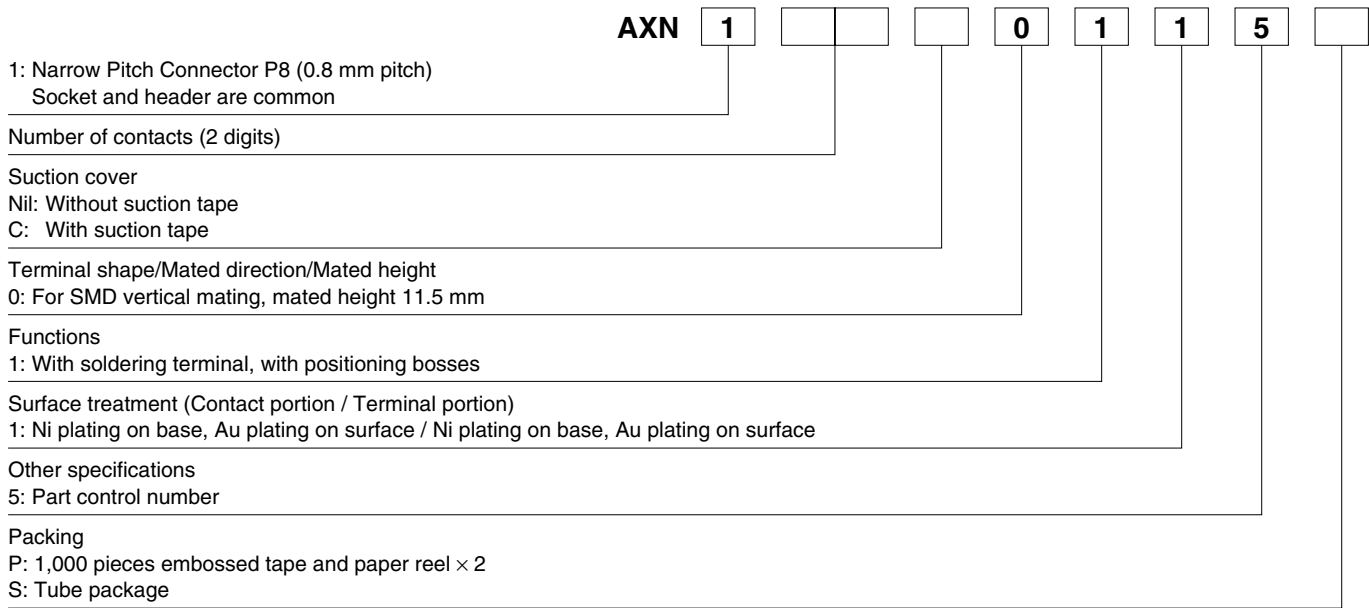

2. P8 (3.0 mm, 3.5 mm, 4.0 mm, 4.5 mm, 5.0 mm, 5.5 mm, 6.0 mm, 7.0 mm, 8.0 mm, 13.0 mm, 14.0 mm)

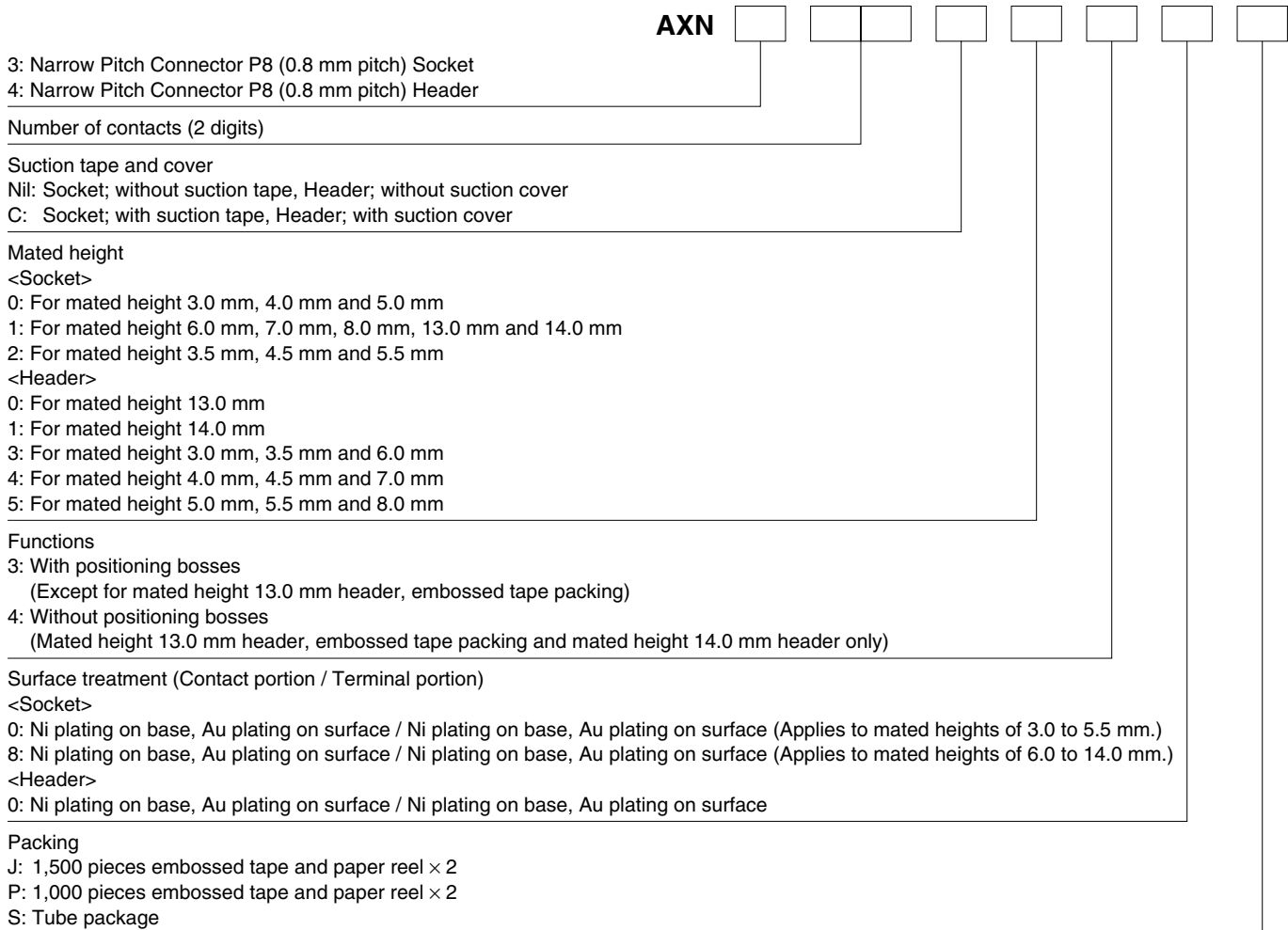

Notes: 1. The tape width for 100-pin embossed tape packaging is non-JIS standard. Please inquire.
2. The depth of the embossed tape for headers with 13 mm and 14 mm mated heights is non-JIS standard. Please test with your mounter before using.
3. Models possible for "J" packaging are as follows:
Socket mated heights: 3.0 mm, 3.5 mm, 4.0 mm, 4.5 mm, 5.0 mm, and 5.5 mm
Headers: Mated heights 3.0 mm, 3.5 mm, and 6.0 mm

PRODUCT TYPES

Mated height	No. of contacts	Stick package				Embossed tape package			
		Part No.		Packing quantity		Part No.		Packing quantity	
		Socket	Header	Stick	Outer carton	Socket	Header	Inner carton (1 reel)	Outer carton
3.0 mm	16	AXN316038S	AXN416330S	50 pcs.	300 pcs.	AXN316038*	AXN416330*		
	20	AXN320038S	AXN420330S	50 pcs.	300 pcs.	AXN320038*	AXN420330*		
	24	AXN324038S	AXN424330S	30 pcs.	300 pcs.	AXN324038*	AXN424330*		
	26	AXN326038S	AXN426330S	30 pcs.	300 pcs.	AXN326038*	AXN426330*		
	30	AXN330038S	AXN430330S	30 pcs.	300 pcs.	AXN330038*	AXN430330*		
	40	AXN340038S	AXN440330S	25 pcs.	300 pcs.	AXN340038*	AXN440330*		
	50	AXN350038S	AXN450330S	20 pcs.	300 pcs.	AXN350038*	AXN450330*		
	60	AXN360038S	AXN460330S	15 pcs.	300 pcs.	AXN360038*	AXN460330*		
	80	AXN380038S	AXN480330S	12 pcs.	300 pcs.	AXN380038*	AXN480330*		
100	AXN300038S	AXN400330S	12 pcs.	300 pcs.	—	—			
3.5 mm	16	AXN316238S	AXN416330S	50 pcs.	300 pcs.	AXN316238*	AXN416330*		
	24	AXN324238S	AXN424330S	30 pcs.	300 pcs.	AXN324238*	AXN424330*		
	26	AXN326238S	AXN426330S	30 pcs.	300 pcs.	AXN326238*	AXN426330*		
	30	AXN330238S	AXN430330S	30 pcs.	300 pcs.	AXN330238*	AXN430330*		
	60	AXN360238S	AXN460330S	15 pcs.	300 pcs.	AXN360238*	AXN460330*		
4.0 mm	16	AXN316038S	AXN416430S	50 pcs.	300 pcs.	AXN316038*	AXN416430P		
	20	AXN320038S	AXN420430S	50 pcs.	300 pcs.	AXN320038*	AXN420430P		
	26	AXN326038S	AXN426430S	30 pcs.	300 pcs.	AXN326038*	AXN426430P		
	30	AXN330038S	AXN430430S	30 pcs.	300 pcs.	AXN330038*	AXN430430P		
	40	AXN340038S	AXN440430S	25 pcs.	300 pcs.	AXN340038*	AXN440430P		
	50	AXN350038S	AXN450430S	20 pcs.	300 pcs.	AXN350038*	AXN450430P		
	60	AXN360038S	AXN460430S	15 pcs.	300 pcs.	AXN360038*	AXN460430P		
	80	AXN380038S	AXN480430S	12 pcs.	300 pcs.	AXN380038*	AXN480430P		
100	AXN300038S	AXN400430S	12 pcs.	300 pcs.	—	—			
4.5 mm	16	AXN316238S	AXN416430S	50 pcs.	300 pcs.	AXN316238*	AXN416430P		
	26	AXN326238S	AXN426430S	30 pcs.	300 pcs.	AXN326238*	AXN426430P		
	30	AXN330238S	AXN430430S	30 pcs.	300 pcs.	AXN330238*	AXN430430P		
	60	AXN360238S	AXN460430S	15 pcs.	300 pcs.	AXN360238*	AXN460430P		
5.0 mm	12	AXN312038S	AXN412530S	50 pcs.	300 pcs.	AXN312038*	AXN412530P	Note 1) "Asterisk" mark on end of part No.; J: 1,500 pieces (recommendation) P: 1,000 pieces	Note 1) "Asterisk" mark on end of part No.; J: 3,000 pieces (recommendation) P: 2,000 pieces
	14	AXN314038S	AXN414530S	50 pcs.	300 pcs.	AXN314038*	AXN414530P		
	20	AXN320038S	AXN420530S	50 pcs.	300 pcs.	AXN320038*	AXN420530P		
	24	AXN324038S	AXN424530S	30 pcs.	300 pcs.	AXN324038*	AXN424530P		
	26	AXN326038S	AXN426530S	30 pcs.	300 pcs.	AXN326038*	AXN426530P		
	30	AXN330038S	AXN430530S	30 pcs.	300 pcs.	AXN330038*	AXN430530P		
	40	AXN340038S	AXN440530S	25 pcs.	300 pcs.	AXN340038*	AXN440530P		
	50	AXN350038S	AXN450530S	20 pcs.	300 pcs.	AXN350038*	AXN450530P		
	60	AXN360038S	AXN460530S	15 pcs.	300 pcs.	AXN360038*	AXN460530P		
	80	AXN380038S	AXN480530S	12 pcs.	300 pcs.	AXN380038*	AXN480530P		
100	AXN300038S	AXN400530S	12 pcs.	300 pcs.	—	—			
5.5 mm	12	AXN312238S	AXN412530S	50 pcs.	300 pcs.	AXN312238*	AXN412530P		
	24	AXN324238S	AXN424530S	30 pcs.	300 pcs.	AXN324238*	AXN424530P		
	26	AXN326238S	AXN426530S	30 pcs.	300 pcs.	AXN326238*	AXN426530P		
	30	AXN330238S	AXN430530S	30 pcs.	300 pcs.	AXN330238*	AXN430530P		
	60	AXN360238S	AXN460530S	15 pcs.	300 pcs.	AXN360238*	AXN460530P		
6.0 mm	20	AXN320130S	AXN420330S	50 pcs.	300 pcs.	AXN320130P	AXN420330*		
	24	AXN324130S	AXN424330S	30 pcs.	300 pcs.	AXN324130P	AXN424330*		
	26	AXN326130S	AXN426330S	30 pcs.	300 pcs.	AXN326130P	AXN426330*		
	30	AXN330130S	AXN430330S	30 pcs.	300 pcs.	AXN330130P	AXN430330*		
	40	AXN340130S	AXN440330S	25 pcs.	300 pcs.	AXN340130P	AXN440330*		
	50	AXN350130S	AXN450330S	20 pcs.	300 pcs.	AXN350130P	AXN450330*		
	60	AXN360130S	AXN460330S	15 pcs.	300 pcs.	AXN360130P	AXN460330*		
	64	AXN364130S	AXN464330S	15 pcs.	300 pcs.	AXN364130P	AXN464330*		
	80	AXN380130S	AXN480330S	12 pcs.	300 pcs.	AXN380130P	AXN480330*		
100	AXN300130S	AXN400330S	12 pcs.	300 pcs.	—	—			
7.0 mm	20	AXN320130S	AXN420430S	50 pcs.	300 pcs.	AXN320130P	AXN420430P		
	22	AXN322130S	AXN422430S	30 pcs.	300 pcs.	AXN322130P	AXN422430P		
	26	AXN326130S	AXN426430S	30 pcs.	300 pcs.	AXN326130P	AXN426430P		
	30	AXN330130S	AXN430430S	30 pcs.	300 pcs.	AXN330130P	AXN430430P		
	40	AXN340130S	AXN440430S	25 pcs.	300 pcs.	AXN340130P	AXN440430P		
	50	AXN350130S	AXN450430S	20 pcs.	300 pcs.	AXN350130P	AXN450430P		
	60	AXN360130S	AXN460430S	15 pcs.	300 pcs.	AXN360130P	AXN460430P		
	80	AXN380130S	AXN480430S	12 pcs.	300 pcs.	AXN380130P	AXN480430P		
100	AXN300130S	AXN400430S	12 pcs.	300 pcs.	—	—			

AXN(1/3/4)

Mated height	No. of contacts	Stick package				Embossed tape package			
		Part No.		Packing quantity		Part No.		Packing quantity	
		Socket	Header	Stick	Outer carton	Socket	Header	Inner carton (1 reel)	Outer carton
8.0 mm	20	AXN320130S	AXN420530S	50 pcs.	300 pcs.	AXN320130P	AXN420530P	1,000 pcs.	2,000 pcs.
	22	AXN322130S	AXN422530S	30 pcs.	300 pcs.	AXN322130P	AXN422530P		
	24	AXN324130S	AXN424530S	30 pcs.	300 pcs.	AXN324130P	AXN424530P		
	26	AXN326130S	AXN426530S	30 pcs.	300 pcs.	AXN326130P	AXN426530P		
	30	AXN330130S	AXN430530S	30 pcs.	300 pcs.	AXN330130P	AXN430530P		
	34	AXN334130S	AXN434530S	30 pcs.	300 pcs.	AXN334130P	AXN434530P		
	40	AXN340130S	AXN440530S	25 pcs.	300 pcs.	AXN340130P	AXN440530P		
	50	AXN350130S	AXN450530S	20 pcs.	300 pcs.	AXN350130P	AXN450530P		
	60	AXN360130S	AXN460530S	15 pcs.	300 pcs.	AXN360130P	AXN460530P		
	80	AXN380130S	AXN480530S	12 pcs.	300 pcs.	AXN380130P	AXN480530P		
	100	AXN300130S	AXN400530S	12 pcs.	300 pcs.	—	—	—	—
11.5 mm	30	AXN1300115S (Socket, Header)		30 pcs.	300 pcs.	AXN1300115P (Socket, Header)		350 pcs.	700 pcs.
	40	AXN1400115S (Socket, Header)		25 pcs.	300 pcs.	AXN1400115P (Socket, Header)		350 pcs.	700 pcs.
	50	AXN1500115S (Socket, Header)		20 pcs.	300 pcs.	AXN1500115P (Socket, Header)		350 pcs.	700 pcs.
	80	AXN1800115S (Socket, Header)		12 pcs.	300 pcs.	AXN1800115P (Socket, Header)		250 pcs.	500 pcs.
	100	AXN1000115S (Socket, Header)		12 pcs.	300 pcs.	—		—	—
13.0 mm	20	AXN320130S	AXN420030S	50 pcs.	300 pcs.	AXN320130P	AXN420040P <small>Note 5)</small>	Socket: 1,000 pcs. Header: 500 pcs.	Socket: 2,000 pcs. Header: 1,000 pcs.
	30	AXN330130S	AXN430030S	30 pcs.	300 pcs.	AXN330130P	AXN430040P <small>Note 5)</small>		
	40	AXN340130S	AXN440030S	25 pcs.	300 pcs.	AXN340130P	AXN440040P <small>Note 5)</small>		
	50	AXN350130S	AXN450030S	20 pcs.	300 pcs.	AXN350130P	AXN450040P <small>Note 5)</small>		
	60	AXN360130S	AXN460030S	15 pcs.	300 pcs.	AXN360130P	AXN460040P <small>Note 5)</small>		
	80	AXN380130S	AXN480030S	12 pcs.	300 pcs.	AXN380130P	AXN480040P <small>Note 5)</small>		
14.0 mm	20	AXN320130S	AXN420130S	50 pcs.	300 pcs.	AXN320130P	AXN420130P	Socket: 1,000 pcs. Header: 400 pcs.	Socket: 2,000 pcs. Header: 800 pcs.

Notes) 1. Please add following suffix at * marked positions.

J: Inner carton (1 reel) 1,500 pcs. (Outer carton: 3,000 pcs.)

P: Inner carton (1 reel) 1,000 pcs. (Outer carton: 2,000 pcs.)

In order to reduce the amount of packaging materials used to help protect the global environment, it is recommended that each packaging box contains 1,500 units with the "J" product number suffix.

As for the part No. P is suffixed, only 1,000 pcs. reel is available.

2. Regarding ordering units: During production: Please make orders in 1-reel units.

Samples for mounting confirmation: Available in units of 50 pieces. Please consult us. (See "Regarding sample orders to confirm proper mounting" on page 19.)

Samples: Small lot orders are possible. Change the suffix "J" to the suffix "P"

3. Connectors with suction tape are also available except for 16 contacts type. For this type of connector, insert the letter "C" between the 6th and 7th column of the ordering number.

Example: For a 20-contact socket with 3mm mated height (embossed tape package): AXN320C038P

4. The standard type comes with positioning bosses. Connectors without positioning bosses are available for on-demand production (3,000 pcs/lot or more).

5. Regarding of 100-contact connectors are please consult us. In an embosses tape package as the required embossed tape width exceeds the JIS standard.

6. The standard type of 13mm embossed tape package does not come with positioning bosses.

SPECIFICATIONS

1. Characteristics

Item		Specifications		Conditions
		3mm, 3.5mm, 4mm, 4.5mm, 5.0mm, 5.5mm, 6.0mm, 7.0mm, 8.0mm, 13.0mm, 14.0mm type	11.5mm type	
Electrical characteristics	Rated current	0.5A		
	Rated voltage	60V AC/DC		
	Breakdown voltage	250V AC for 1 minute		Detection current: 1mA
	Insulation resistance	Min. 1,000MΩ		Using 500V DC megger
	Contact resistance	Max. 60mΩ	Max. 50mΩ	Based on the contact resistance measurement method specified by JIS C 5402.
Mechanical characteristics	Composite insertion force	Max. 43.1N {4.40kgf} (30 contacts)	Max. 0.785N {80gf} × no. of contacts (initial)	
	Composite removal force	Min. 6.37N {0.65kgf} (30 contacts)	Min. 0.127N {13gf} × no. of contacts	
	Contact holding force	40 contacts or less: Min. 1.96N {200 gf} 50 contacts or more: Min. 0.981N {100 gf}	Min. 1.96N {200 gf}	Measuring the maximum force. As the contact is axially pull out.
Environmental characteristics	Ambient temperature	-55°C to +85°C		No freezing at low temperatures
	Soldering heat resistance	Max. peak temperature of 245°C (on the surface of the PC board around the connector terminals)		Infrared reflow soldering
		300°C within 5 seconds		Soldering iron
	Thermal shock resistance (header and socket mated)	5 cycles, insulation resistance min. 100MΩ, contact resistance max. 60mΩ	5 cycles, insulation resistance min. 100MΩ, contact resistance max. 50mΩ	Sequence 1. -55 [±] 3°C, 30 minutes 2. ~, Max. 5 minutes 3. 85 [±] 3°C, 30 minutes 4. ~, Max. 5 minutes
	Humidity resistance (header and socket mated)	120 hours, insulation resistance min. 100MΩ, contact resistance max. 60mΩ	240 hours, insulation resistance min. 100MΩ, contact resistance max. 50mΩ	Bath temperature 40±2°C, humidity 90 to 95% R.H.
	Saltwater spray resistance (header and socket mated)	24 hours, insulation resistance min. 100MΩ, contact resistance max. 60mΩ	48 hours, insulation resistance min. 100MΩ, contact resistance max. 50mΩ	Bath temperature 35±2°C, saltwater concentration 5±1%
	H ₂ S resistance (header and socket mated)	48 hours, contact resistance max. 60mΩ	96 hours, contact resistance max. 50mΩ	Bath temperature 40±2°C, gas concentration 3±1 ppm, humidity 75 to 80% R.H.
SO ₂ resistance (header and socket mated)	48 hours, contact resistance max. 60mΩ	96 hours, contact resistance max. 50mΩ	Bath temperature 40±2°C, gas concentration 10±3 ppm, humidity 90 to 95% R.H.	
Lifetime characteristics	Insertion and removal life	50 times	100 times	Repeated insertion and removal speed of max. 200 times/hours
Unit weight	Mated height 3mm 30 contacts; Socket: 0.26g Header: 0.26g 50 contacts; Socket: 0.40g Header: 0.44g			

2. Material and surface treatment

Part name	3.0mm, 3.5mm, 4.0mm, 4.5mm, 5.0mm, 5.5mm, 6.0mm, 7.0mm, 8.0mm, 13.0mm, 14.0mm type		11.5mm type	
	Material	Surface treatment	Material	Surface treatment
Molded portion	Heat-resistant resin (UL94V-0)	—	Liquid crystal polymer resin (UL94V-0)	—
Bracket	—	—	Copper alloy	Cu plating on base, Sn plating on surface
Contact	Copper alloy	Contact portion: Ni plating on base, Au plating on surface Terminal portion: Ni plating on base, Au plating on surface (Except for thick of terminal)	Copper alloy	Contact portion: Ni plating on base, Au plating on surface Terminal portion: Ni plating on base, Au plating on surface (Except for thick of terminal)

AXN(1/3/4)

DIMENSIONS (Unit: mm) The CAD data of the products with a **CAD Data** mark can be downloaded from: <http://panasonic-electric-works.net/ac>

• Mated height 3.0mm, 4.0mm, 4.5mm, 5.0mm, 5.5mm, 6.0mm, 7.0mm, 8.0mm, 13.0mm, 14.0mm type

1) Socket

CAD Data

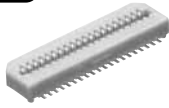

Dimension table (mm)

No. of contacts	A	B	C	D	E	F
12	7.40	4.00	6.30	6.30	4.00	0.1
14	8.20	4.80	7.10	7.10	4.80	
16	9.00	5.60	7.90	7.90	5.60	
20	10.60	7.20	9.50	9.50	7.20	
22	11.40	8.00	10.30	10.30	8.00	
24	12.20	8.80	11.10	11.10	8.80	
26	13.00	9.60	11.90	11.90	9.60	
30	14.60	11.20	13.50	13.50	11.20	
34	16.20	12.80	15.10	15.10	12.80	
40	18.60	15.20	17.50	17.50	15.20	
50	23.40	19.20	21.50	21.50	19.20	0.15
60	27.40	23.20	25.50	25.50	23.20	
64	29.00	24.80	27.10	27.10	24.80	
80	35.40	31.20	33.50	33.50	31.20	
100	43.40	39.20	41.50	41.50	39.20	

Mated height	G
3.0mm, 4.0mm, 5.0mm common	2.2
3.5mm, 4.5mm, 5.5mm common	2.7
6.0mm, 7.0mm, 8.0mm, 13.0mm, 14.0mm common	5.2

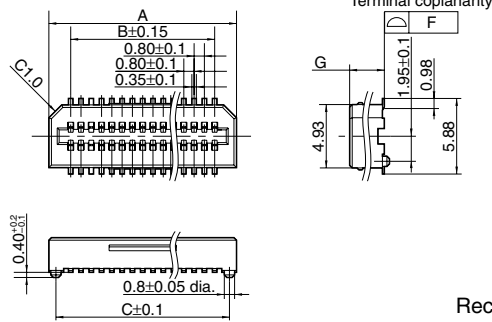

General tolerance: ±0.3

Recommended PC board pattern (TOP VIEW)

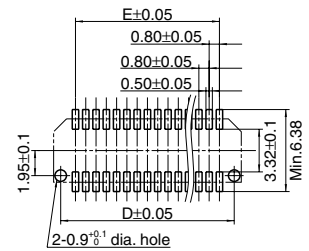

2) Header

CAD Data

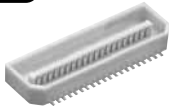

Dimension table (mm)

No. of contacts	A	B	C	D	E	F
12	8.45	4.00	6.30	6.30	4.00	0.1
14	9.25	4.80	7.10	7.10	4.80	
16	10.05	5.60	7.90	7.90	5.60	
20	11.65	7.20	9.50	9.50	7.20	
22	12.45	8.00	10.30	10.30	8.00	
24	13.25	8.80	11.10	11.10	8.80	
26	14.05	9.60	11.90	11.90	9.60	
30	15.65	11.20	13.50	13.50	11.20	
34	17.25	12.80	15.10	15.10	12.80	
40	19.65	15.20	17.50	17.50	15.20	
50	25.85	19.20	21.50	21.50	19.20	Note) 0.15
60	29.85	23.20	25.50	25.50	23.20	
64	31.45	24.80	27.10	27.10	24.80	
80	37.85	31.20	33.50	33.50	31.20	
100	45.85	39.20	41.50	41.50	39.20	

Note) The 13 mm mated height (20 to 80 contacts) terminal flatness is 0.1 mm.

Mated height	G
3.0mm, 3.5mm, 6.0mm common	2.72
4.0mm, 4.5mm, 7.0mm common	3.72
5.0mm, 5.5mm, 8.0mm common	4.72
13.0mm	10.14
14.0mm	11.14

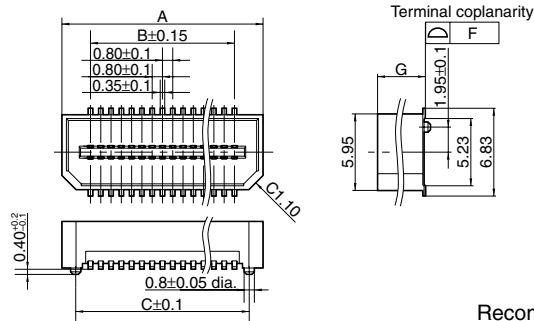

General tolerance: ±0.3

Recommended PC board pattern (TOP VIEW)

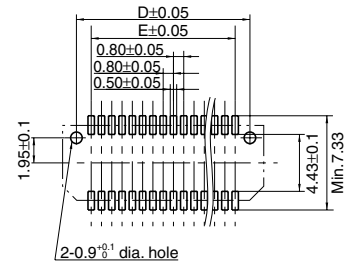

3) Socket and header are mated

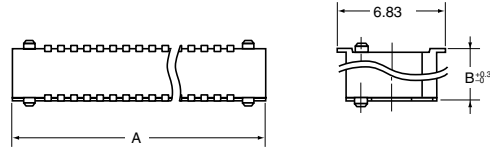

Dimension table (mm)

No. of contacts	A	Mated height	B
12	8.45	3.0mm	3
14	9.25	3.5mm	3.5
16	10.05	4.0mm	4
20	11.65	4.5mm	4.5
22	12.45	5.0mm	5
24	13.25	5.5mm	5.5
26	14.05	6.0mm	6
30	15.65	7.0mm	7
34	17.25	8.0mm	8
40	19.65	13.0mm	13
50	25.85	14.0mm	14
60	29.85		
64	31.45		
80	37.85		
90	41.85		
100	45.85		

Note) Common for all mated heights.

- Mated height 11.5mm type (Socket and Header) (30 contacts, 40 contacts, 50 contacts)

CAD Data

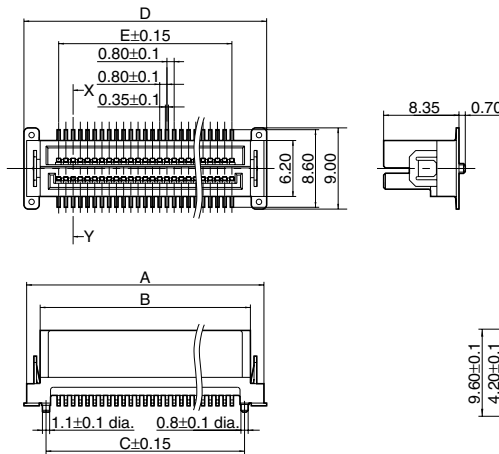
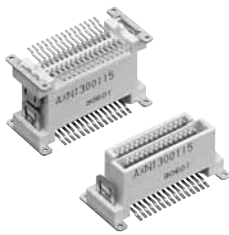

Recommended PC board pattern (TOP VIEW)

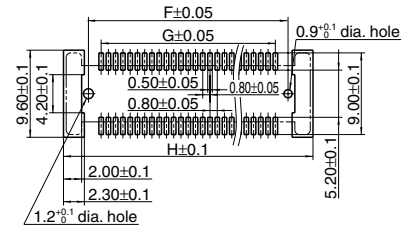

General tolerance: ± 0.3

Dimension table (mm)

No. of contacts	A	B	C	D	E	F	G	H
30	18.9	15.3	14.0	18.9	11.2	14.0	11.2	19.5
40	22.9	19.3	18.0	22.9	15.2	18.0	15.2	23.5
50	26.9	23.3	22.0	26.9	19.2	22.0	19.2	27.5

X-Y cross section

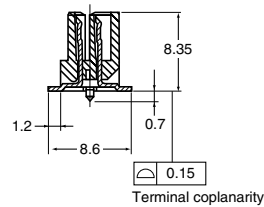

Stacking mated diagram

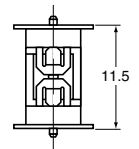

AXN(1/3/4)

- Mated height 11.5mm type (Socket and Header)
(80 contacts, 100 contacts)

CAD Data

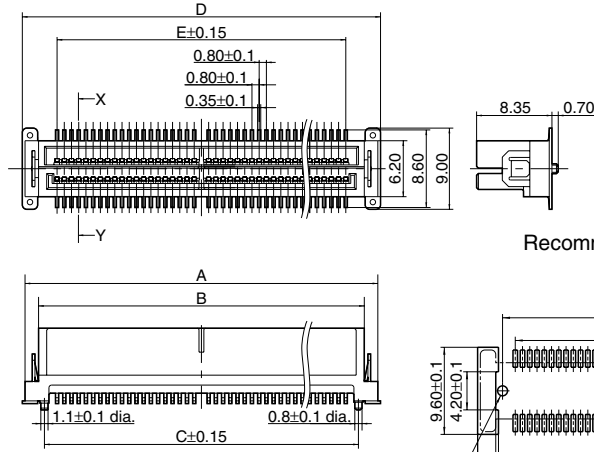

General tolerance: ±0.3

Recommended PC board pattern (TOP VIEW)

Note) Center terminal is removed for 80 and 100 contact type

Dimension table (mm)

No. of contacts	A	B	C	D	E	F	G	H
80	39.7	36.1	34.8	39.7	32.0	34.8	32.0	40.3
100	47.7	44.1	42.8	47.7	40.0	42.8	40.0	48.3

X-Y cross section

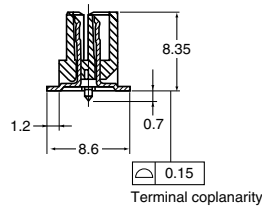

Stacking mated diagram

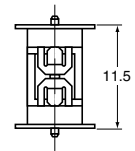

EMBOSSED TAPE DIMENSIONS (unit: mm, Common for respective contact type, socket and header)

- Tape dimensions (Conforming to JIS C 0806-1990.

However, some tapes have mounting hole pitches that do not comply with the standard.)

- Paper reel dimensions (Conforming to JIS C 0806-1990)

Tape I

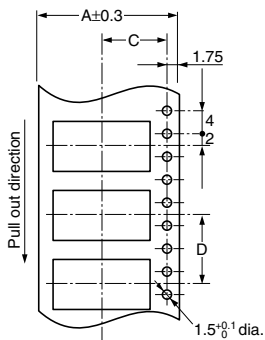

Tape II

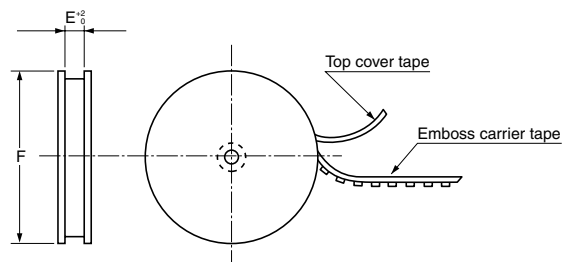
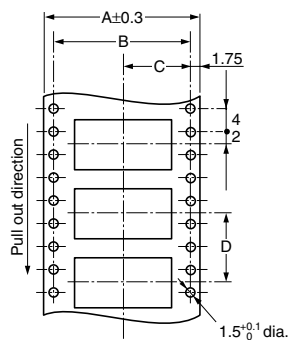

Dimension table (mm)

(1) Suffix: J (1 reel, 1,500 pieces embossed tape package)

Mated height	No. of contacts	Type of taping	A	B	C	D	E	F	Quantity per reel
Socket: 3.0mm, 3.5mm, 4.0mm, 4.5mm, 5.0mm, 5.5mm Header: 3.0mm, 3.5mm, 6.0mm	12 to 32	Tape I	24.0	—	11.5	12.0	24.4	370 dia.	1,500 pcs.
	34 to 40	Tape II	32.0	28.4	14.2	12.0	32.4	370 dia.	
	50 to 60	Tape II	44.0	40.4	20.2	12.0	44.4	370 dia.	
	80	Tape II	56.0	52.4	26.2	12.0	56.4	370 dia.	

(2) Suffix: P (1 reel, 1,000, 500, 350 and 250 pieces embossed tape package)

Mated height	No. of contacts	Type of taping	A	B	C	D	E	F	Quantity per reel
Socket: 3.0mm, 3.5mm, 4.0mm, 4.5mm, 5.0mm, 5.5mm Header: 3.0mm, 3.5mm, 4.0mm, 4.5mm, 6.0mm, 7.0mm	12 to 32	Tape I	24.0	—	11.5	12.0	24.4	330 dia.	1,000 pcs.
	34 to 40	Tape II	32.0	28.4	14.2	12.0	32.4	330 dia.	
	50 to 60	Tape II	44.0	40.4	20.2	12.0	44.4	330 dia.	
	80	Tape II	56.0	52.4	26.2	12.0	56.4	330 dia.	
Socket: 6.0mm, 7.0mm, 8.0mm, 13.0mm, 14.0mm Header: 5.0mm, 5.5mm, 8.0mm	16 to 32	Tape I	24.0	—	11.5	12.0	24.4	370 dia.	1,000 pcs.
	34 to 40	Tape II	32.0	28.4	14.2	12.0	32.4	370 dia.	
	50 to 60	Tape II	44.0	40.4	20.2	12.0	44.4	370 dia.	
	80	Tape II	56.0	52.4	26.2	12.0	56.4	370 dia.	
11.5mm	30 to 40	Tape II	32.0	28.4	14.2	24.0	32.4	370 dia.	350 pcs.
	50	Tape II	44.0	40.4	20.2	24.0	44.4	370 dia.	350 pcs.
	80	Tape II	56.0	52.4	26.2	24.0	56.4	370 dia.	250 pcs.
Header: 13.0mm	20	Tape I	24.0	—	11.5	16.0	24.4	370 dia.	500 pcs.
	30	Tape I	24.0	—	11.5	16.0	24.4	370 dia.	500 pcs.
	40	Tape II	32.0	28.4	14.2	16.0	32.4	370 dia.	500 pcs.
	50	Tape II	44.0	40.4	20.2	16.0	44.4	370 dia.	500 pcs.
	60	Tape II	44.0	40.4	20.2	16.0	44.4	370 dia.	500 pcs.
	80	Tape II	56.0	52.4	26.2	16.0	56.4	370 dia.	500 pcs.
Header: 14.0mm	20	Tape I	24.0	—	11.5	16.0	24.4	370 dia.	400 pcs.

Connector orientation with respect to direction of progress of embossed tape

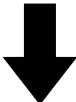
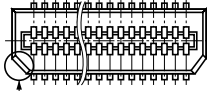
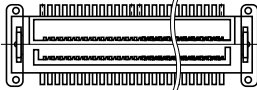
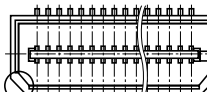
Direction of tape progress	Type	Mated height: 3.0mm, 3.5mm, 4.0mm, 4.5mm, 5.0mm, 5.5mm, 6.0mm, 7.0mm, 8.0mm, 13.0mm	Stacking height 11.5mm
	Socket	 This corner is oriented on the C side.	 Socket and header are common
	Header	 This corner is oriented on the C side.	

NOTES

Note that types having a mated height of 11.5mm cannot be mated with products having other mated heights even though the shape of their socket headers is the same as the rated shape (position of the positioning boss and arrangement of mounting pads) is different.

For other details, please verify with the product specification sheets.