

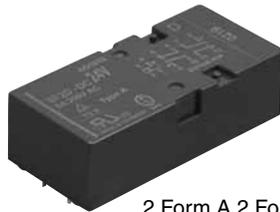

**Flat type safety relays  
(double contact)**

**SF RELAYS**  
Double contact type



2 Form A 2 Form B



4 Form A 4 Form B

**RoHS compliant**

### FEATURES

**1. High contact reliability**

High contact reliability is achieved through the use of a double contact.

**2. Forced operation contacts**

N.O. and N.C. side contacts are connected through a card so that one interacts with the other in movement. In case of a contact welding, the other keeps a min. 0.5mm .020inch contact gap.

**3. Independent operation contacts (4 Form A 4 Form B)**

There are 4 points of forced operation contacts. Each pair of contacts is free from the main armature and is independent from each other. So if a N.O. pair of contacts are welded, the other 3 N.O. contacts are not effected (operate properly) That enables to plan a circuit to detect welding or go back to the beginning condition.

**4. Separated chamber structure**

N.O. and N.C. side contacts are put in each own space surrounded with a card and a body-separator. That prevents short circuit between contacts, which is caused by their springs welding or damaged.

**5. High breakdown voltage**

High breakdown voltage 2,500 Vrms between contacts and coil.

**6. High sensitivity**

Realizes thin shape and high sensitivity (500 mW nominal operating power) by utilizing high-efficiency polarized magnetic circuit with 4-gap balanced armature.

**7. Complies with safety standards**

Standard products are UL, CSA, TÜV and SEV certified. Conform to European standards. TÜV certified. Complies with SUVA European standard.

### TYPICAL APPLICATIONS

1. Industrial equipment such as presses and machine tools
2. Elevators and other kinds of hoisting mechanisms, conveyor equipment.

### ORDERING INFORMATION

SF  D -

Contact arrangement  
2: 2 Form A 2 Form B  
4: 4 Form A 4 Form B

Nominal coil voltage  
DC 5, 12, 24, 48, 60V

Note: Certified by UL, CSA, TÜV and SEV

### TYPES

Contact arrangement	Nominal coil voltage	Part No.
2 Form A 2 Form B	5V DC	SF2D-DC5V
	12V DC	SF2D-DC12V
	24V DC	SF2D-DC24V
	48V DC	SF2D-DC48V
	60V DC	SF2D-DC60V
4 Form A 4 Form B	5V DC	SF4D-DC5V
	12V DC	SF4D-DC12V
	24V DC	SF4D-DC24V
	48V DC	SF4D-DC48V
	60V DC	SF4D-DC60V

Standard packing: Carton: 20 pcs.; Case: 200 pcs.

# SF Double contact type

## RATING

### 1. Coil data

Contact arrangement	Nominal coil voltage	Pick-up voltage (at 20°C 68°F)	Drop-out voltage (at 20°C 68°F)	Nominal coil current [±10%] (at 20°C 68°F)	Coil resistance [±10%] (at 20°C 68°F)	Nominal operating power (at 20°C 68°F)	Max. applied voltage (at 20°C 68°F)
2 Form A 2 Form B	5V DC	75%V or less of nominal voltage (Initial)	10%V or more of nominal voltage (Initial)	100mA	50Ω	500mW	120%V of nominal voltage
	12V DC			41.7mA	288Ω		
	24V DC			20.8mA	1,152Ω		
	48V DC			10.4mA	4,608Ω		
	60V DC			8.3mA	7,200Ω		
4 Form A 4 Form B	5V DC	75%V or less of nominal voltage (Initial)	15%V or more of nominal voltage (Initial)	100mA	50Ω	500mW	
	12V DC			41.7mA	288Ω		
	24V DC			20.8mA	1,152Ω		
	48V DC			10.4mA	4,608Ω		
	60V DC			8.3mA	7,200Ω		

### 2. Specifications

Characteristics	Item	Specifications	
Contact	Arrangement	2 Form A 2 Form B   4 Form A 4 Form B	
	Contact resistance (Initial)	Max. 30 mΩ (By voltage drop 6 V DC 1A)	
	Contact material	Au-flashed AgSnO <sub>2</sub> type	
Rating	Nominal switching capacity (resistive load)	6A 250V AC, 6A 30V DC	
	Max. switching power (resistive load)	1,500VA 180W	
	Max. switching voltage	440V AC, 30V DC	
	Max. switching current	6A	
	Nominal operating power	500mW	
	Min. switching capacity (Reference value)*1	100mA 5V DC	
Electrical characteristics	Insulation resistance (Initial)	Min. 1,000MΩ (at 500V DC) Measurement at same location as "Breakdown voltage" section.	
	Breakdown voltage (Initial)	Between open contacts	1,300 Vrms for 1min. (Detection current: 10mA)
		Between contact sets	2,500 Vrms for 1min. (Detection current: 10mA)
		Between contact and coil	2,500 Vrms for 1min. (Detection current: 10mA)
	Temperature rise (coil) (at 20° 68°F)	Max. 45°C 113°F (By resistive method, nominal voltage applied to the coil; contact carrying current: 6A)	
	Operate time	Max. 30ms (Nominal voltage applied to the coil, excluding contact bounce time.)	
	Release time	Max. 15ms (Nominal voltage applied to the coil, excluding contact bounce time.) (without diode)	
Mechanical characteristics	Shock resistance	Functional	Min. 294 m/s <sup>2</sup> (Half-wave pulse of sine wave: 11 ms; detection time: 10μs)
		Destructive	Min. 980 m/s <sup>2</sup> (Half-wave pulse of sine wave: 6 ms)
	Vibration resistance	Functional	10 to 55 Hz at double amplitude of 2 mm (Detection time: 10μs)
		Destructive	10 to 55 Hz at double amplitude of 2 mm
Expected life	Mechanical	Min. 10 <sup>7</sup> (at 180 times/min.)	
	Electrical	Min. 10 <sup>5</sup> (at 20 times/min.)	
Conditions	Conditions for operation, transport and storage*2	Ambient temperature: -40°C to +70°C -40°F to +158°F Humidity: 5 to 85% R.H. (Not freezing and condensing at low temperature)	
	Max. Operating speed	180 times/min.	
Unit weight		Approx. 38g 1.34oz   Approx. 47g 1.66oz	

Notes: \*1. This value can change due to the switching frequency, environmental conditions and desired reliability level, therefore it is recommended to check this with the actual load.

\*2. The upper limit of the ambient temperature is the maximum temperature that can satisfy the coil temperature rise value. Refer to Usage, transport and storage conditions in NOTES.

## REFERENCE DATA

### 1. Operate/release time (without diode)

Tested sample: SF2D-DC24V (2 Form A 2 Form B)  
Quantity: n = 20

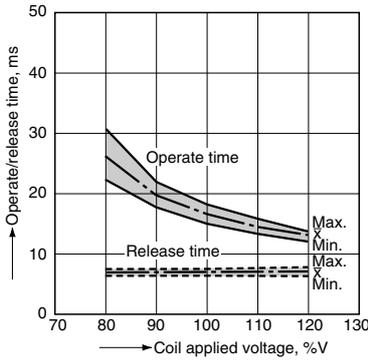

### 2. Temperature rise

Tested sample: SF4D-DC24V (4 Form A 4 Form B)  
Quantity: n = 6  
Coil applied voltage: 100%V, 120%V  
Contact carry current: 6A

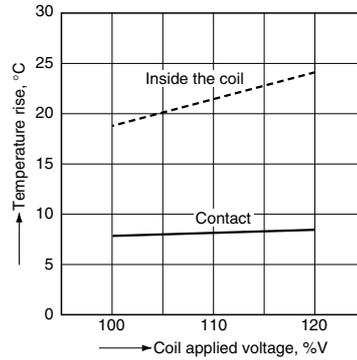

### 3. Ambient temperature characteristics

Tested sample: SF4D-DC24V (4 Form A 4 Form B)  
Quantity: n = 6

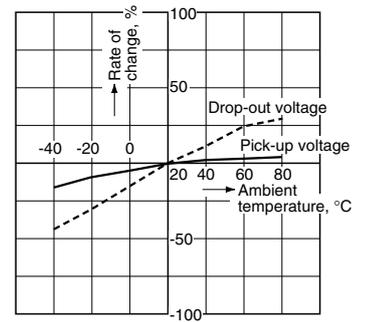

## DIMENSIONS (mm inch)

The CAD data of the products with a **CAD Data** mark can be downloaded from: <http://industrial.panasonic.com/ac/e/>

### 1. 2 Form A 2 Form B

**CAD Data**



#### External dimensions

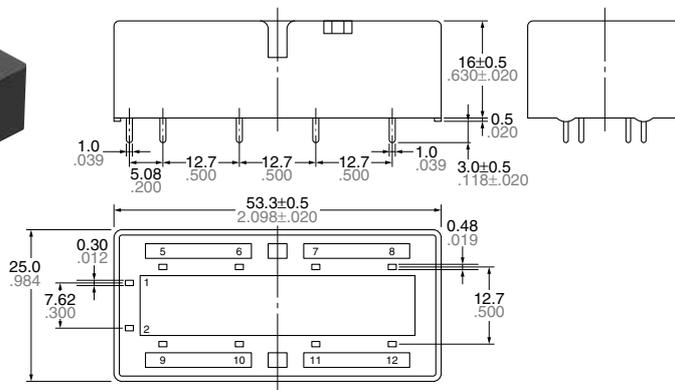

General tolerance:  $\pm 0.3 \pm 0.12$

#### Schematic (Bottom view)

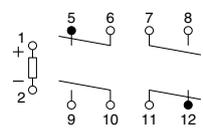

#### PC board pattern (Bottom view)

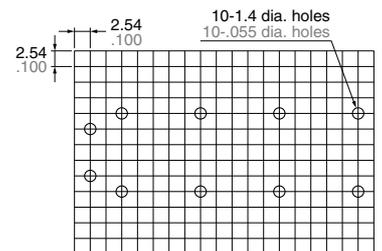

Tolerance:  $\pm 0.1 \pm 0.004$

### 2. 4 Form A 4 Form B

**CAD Data**



#### External dimensions

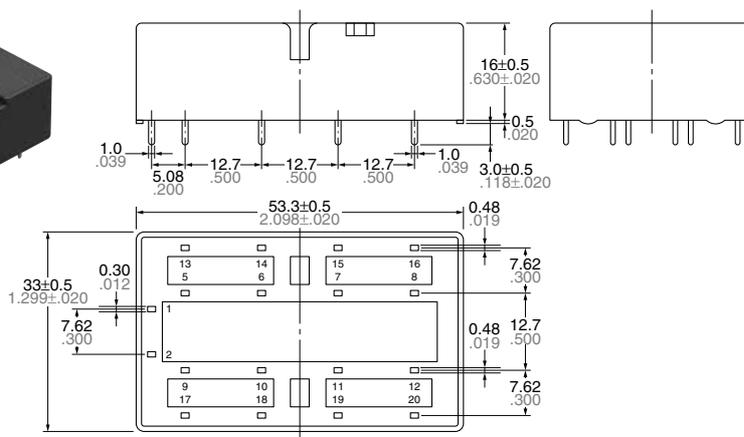

General tolerance:  $\pm 0.3 \pm 0.12$

#### Schematic (Bottom view)

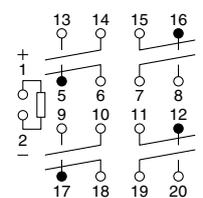

#### PC board pattern (Bottom view)

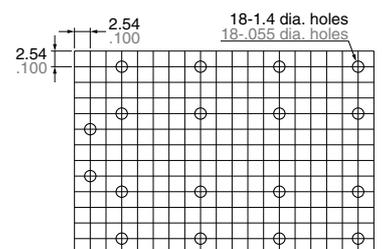

Tolerance:  $\pm 0.1 \pm 0.004$

# SF Double contact type

## SAFETY STANDARDS

UL/C-UL (Recognized)		TÜV (Certified)		SEV	
File No.	Contact rating	File No.	Rating	File No.	Contact rating
E120782*	6A 250V AC 6A 24V DC	968 EZ 116.03/10 (SF2D) 968 EZ 116.02/09 (SF4D)	3A 24V DC 6A 250V AC	12.0520	6A 24V DC 6A 250V AC

\* CSA standard: Certified by C-UL

## SAFETY STRUCTURE OF SF RELAYS

This SF relay design ensures that subsequent operations shut down and can automatically return to a safe state when the SF relay suffers overloading and other circuit abnormalities

(unforeseen externally caused circuit or device breakdowns, end of life incidents, and noise, surge, and environmental influences) owing to contact welding, spring fusion or, in the worst-case

scenario, relay breakdown (coil rupture, faulty operation, faulty return, and fatigue and breakage of the operating spring and return spring), and even in the event of end of life.

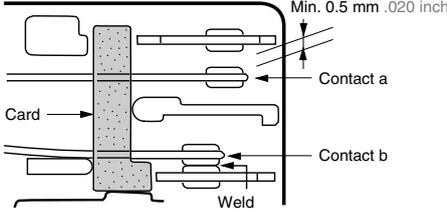
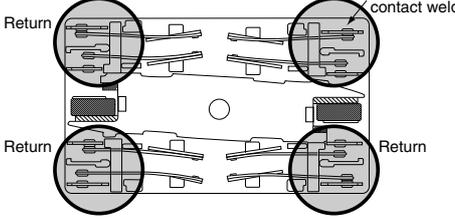
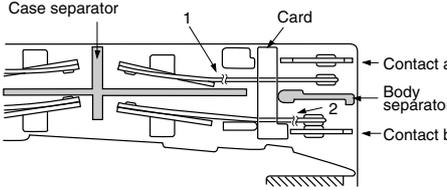
	Structure	Operation
1. Forced operation method (2 Form A 2 Form B, 4 Form A 4 Form B types)	 <p>The two contacts "a" and "b" are coupled with the same card. The operation of each contact is regulated by the movement of the other contact.</p>	<p>Even when one contact is welded closed, the other maintains a gap of greater than 0.5 mm .020 inch.</p> <p>In the diagram on the left, the lower contact "b" have welded but the upper contact "a" maintain a gap of greater than 0.5 mm .020 inch. Subsequent contact movement is suspended and the weld can be detected</p>
2. Independent operation method (4 Form A 4 Form B type)	 <p>None of four contacts are held in position by the armature. Even though one of the external N.O. contacts has welded, the other three contacts have returned owing to the de-energizing of the coil.</p>	<p>Enables design of safety circuits that allow weld detection and return at an early stage.</p> <p>As shown at the top right of the diagram on the left, if the external N.O. contact welds, a 0.5 mm .020 inch gap is maintained. Each of the other contacts returns to N.O. because the coil is no longer energized.</p>
3. Separate chamber method (2 Form A 2 Form B, 4 Form A 4 Form B types)	 <p>In independent chambers, the contacts "a" and "b" are kept apart by a body/case separator or by the card itself.</p>	<p>Prevents shorting and fusing of springs and spring failure owing to short-circuit current.</p> <p>As shown on the diagram on the left, even if the operating springs numbered 1 and 2 there is no shorting between "a" and "b" contacts.</p>
4. 2 Form A 2 Form B contact 4 Form A 4 Form B contact	Structure with independent COM contact of 2 Form A 2 Form B and 4 Form A 4 Form B contacts.	Independent COM enables differing pole circuit configurations. This makes it possible to design various kinds of control circuits and safety circuits.

## THE OPERATION OF SF RELAYS (when contacts are welded)

SF relays work to maintain a normal operating state even when the contact welding occur by overloading or short-circuit currents. It is easy to make weld detection circuits and safety circuits in the design to ensure safety even if contacts weld.

### 1) 2 Form A 2 Form B type

#### Form "b" Contact Weld

If the form "b" contact (No. 1 and 3) welds, the armature becomes non-operational, the contact gaps at the three form "a" contacts are maintained at greater than 0.5 mm .020 inch. Reliable isolation is thus ensured.

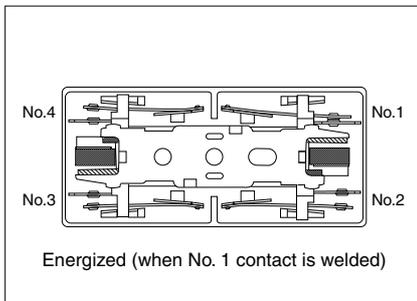
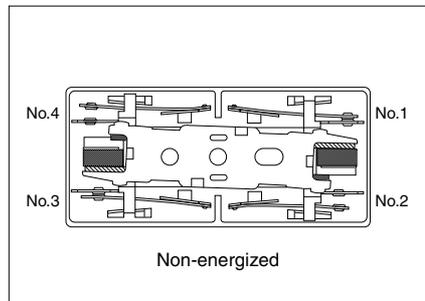

**Example: If the No. 1 contact welds**  
Each of the three form "a" contacts (No. 2 and 4) maintain a gap of greater than 0.5 mm .020 inch.

#### Form "a" Contact Weld

When the form "a" contacts (No. 2 or 4) weld, the armature remains in a non-returned state and the contact gap at the two form "b" contact is maintained at greater than 0.5 mm .020 inch. Reliable isolation is thus ensured.

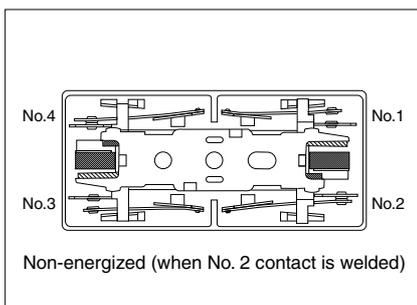
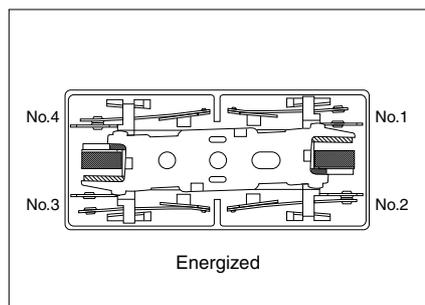

**Example: If the No. 2 contact welds.**  
The two form "b" contact (No. 1 or 3) maintains a gap of greater than 0.5 mm .020 inch.

#### Contact Operation Table

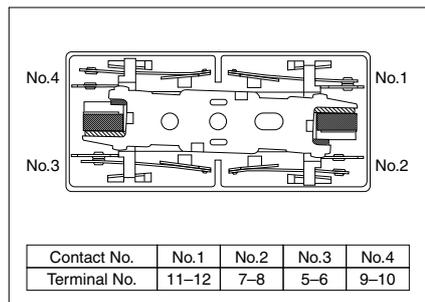

The table below shows the state of the other contacts when the current through the welded form "a" contact is 0 V and the rated voltage is applied through the form "b" contact.

		State of other contacts			
		1	2	3	4
Welded terminal No.	1		>0.5	>0.5	>0.5
	2	>0.5		>0.5	
	3	>0.5	>0.5		>0.5
	4	>0.5		>0.5	

>0.5: contact gap is kept at min. 0.5 mm .020 inch  
Empty cells: either closed or open

\* Contact gaps are shown at the initial state.  
If the contacts change state owing to loading/breaking it is necessary to check the actual loading.

# SF Double contact type

## 2) 4 Form A 4 Form B type

### Internal Contacts Weld

When internal contacts (No. 2, No. 3, No. 6 or No. 7) are welded, the armature becomes non-operational and the four form "a" contact gaps are maintained at 0.5 mm .020inch or greater. Reliable cut-off is thus ensured.

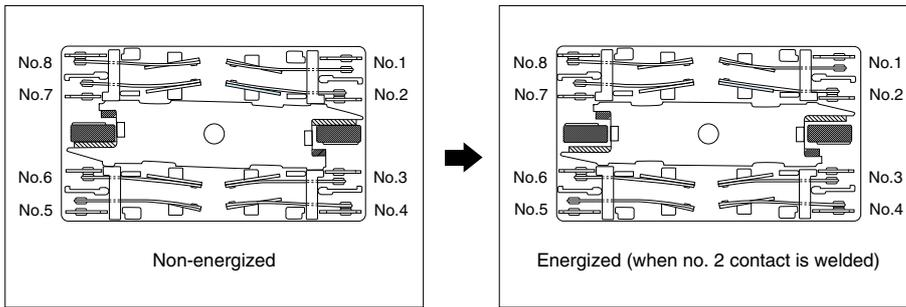

**Example:** If the No. 2 contact welds. Each of the four form "a" contacts (No. 1, 3, 5, and 7) maintains a gap of greater than 0.5 mm .020 inch.

### External Contacts Weld

When external contacts (No. 1, No. 4, No. 5 or No. 8) are welded, gaps of 0.5 mm .020inch and greater are maintained between adjacent contacts and other contacts operate normally by the coil being non-energized.

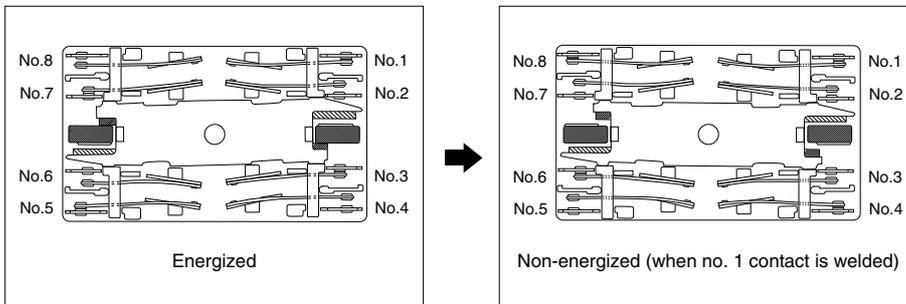

**Example 1:** If the No. 1 contact welds. The adjacent No. 2 contact maintains a gap of greater than 0.5 mm .020 inch. The other contacts, because the coil is not energized, return to their normal return state; each of form "a" contacts (No. 3, 5, and 7) maintains a contact gap of greater than 0.5 mm .020 inch; each of the form "b" contacts (No. 4, 6, and 8) return to a closed state.

**Example 2:**  
If external connections are made in series. Even if one of the contacts welds, the other contacts operate independently and the contact gaps are maintained at greater than 0.5 mm .020 inch.

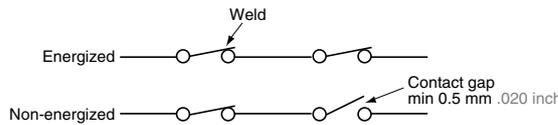

### Contact Operation Table

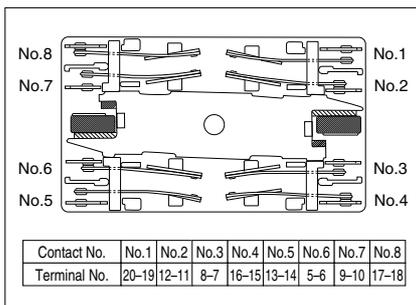

The table below shows the state of the other contacts when the current through the welded form "a" contact is 0 V and the rated voltage is applied through the form "b" contact.

Contact No.	State of other contacts							
	1	2	3	4	5	6	7	8
1		>0.5	>0.5	≠	>0.5	≠	>0.5	≠
2	>0.5		>0.5		>0.5		>0.5	
3		>0.5		>0.5		>0.5		>0.5
4	≠	>0.5	>0.5		≠	>0.5	≠	>0.5
5	>0.5	≠	>0.5	≠		>0.5	>0.5	≠
6	>0.5		>0.5		>0.5		>0.5	
7		>0.5		>0.5		>0.5		>0.5
8	>0.5	>0.5	≠	>0.5	≠	>0.5	>0.5	

>0.5: contact gap is kept at min. 0.5 mm .020 inch  
≠: contact closed  
Empty cells: either closed or open

\* Contact gaps are shown at the initial state. If the contacts change state owing to loading/breaking it is necessary to check the actual loading.

## NOTES

1. For cautions for use, please read "General Application Guidelines".