

Electrical life: Min. 2×10^5
1a 10A, 1a1b 8A small
polarized power relays

ADY RELAYS (ADY)



RoHS compliant

FEATURES

1. Compact size:
1 Form A (10A 250V AC),
1 Form A 1 Form B (8A 250V AC)
2. Latching types available
3. Compliant with IEC EN61010-1.
Reinforced insulation with 6 mm
distance between input and output.
4. Electrical life of Min. 2×10^5 times
(1 Form A type) realized with
inductive load ($\cos\phi=0.4$, $L/R=7ms$,
5A 250V AC)
5. Sockets are available.

TYPICAL APPLICATIONS

1. Control for industrial machines
(machine tools, robotics)
2. Output relays for temperature
controllers, PLCs, timers, sensors.
3. Measuring equipment
4. Security equipment

| | Product name | Part No. |
|----------------------|-------------------------|-----------|
| 1 Form A | Single side stable type | DK1a-PS |
| | 2 coil latching type | DK1a-PSL2 |
| 1 Form A 1 Form B | Single side stable type | DK2a-PS |
| | 2 coil latching type | DK2a-PSL2 |

Please see "DK relay socket" for details.

ORDERING INFORMATION

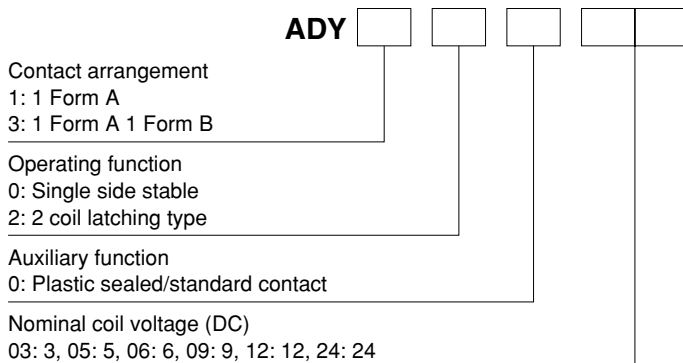

Note: Certified by UL, CSA and TÜV

TYPES

| Contact arrangement | Nominal coil voltage | Single side stable | 2 coil latching |
|----------------------|----------------------|--------------------|-----------------|
| | | Part No. | Part No. |
| 1 Form A | 3V DC | ADY10003 | ADY12003 |
| | 5V DC | ADY10005 | ADY12005 |
| | 6V DC | ADY10006 | ADY12006 |
| | 12V DC | ADY10012 | ADY12012 |
| | 24V DC | ADY10024 | ADY12024 |
| 1 Form A 1 Form B | 3V DC | ADY30003 | ADY32003 |
| | 5V DC | ADY30005 | ADY32005 |
| | 6V DC | ADY30006 | ADY32006 |
| | 12V DC | ADY30012 | ADY32012 |
| | 24V DC | ADY30024 | ADY32024 |

Standard packing: Carton: 50 pcs.; Case: 500 pcs.

* For sockets, see page 140.

RATING

1. Coil data

1) Single side stable

| Nominal coil voltage | Pick-up voltage (at 20°C 68°F) | Drop-out voltage (at 20°C 68°F) | Nominal operating current [±10%] (at 20°C 68°F) | Coil resistance [±10%] (at 20°C 68°F) | Nominal operating power | Max. applied voltage (at 20°C 68°F) |
|----------------------|---|---|---|---------------------------------------|-------------------------|-------------------------------------|
| 3V DC | 70%V or less of nominal voltage (Initial) | 10%V or more of nominal voltage (Initial) | 66.6mA | 45Ω | 200mW | 130%V of nominal voltage |
| 5V DC | | | 40mA | 125Ω | | |
| 6V DC | | | 33.3mA | 180Ω | | |
| 12V DC | | | 16.6mA | 720Ω | | |
| 24V DC | | | 8.3mA | 2,880Ω | | |

2) 2 coil latching

| Nominal coil voltage | Set voltage (at 20°C 68°F) | Reset voltage (at 20°C 68°F) | Nominal operating current [±10%] (at 20°C 68°F) | | Coil resistance [±10%] (at 20°C 68°F) | | Nominal operating power | | Max. applied voltage (at 20°C 68°F) |
|----------------------|---|---|---|------------|---------------------------------------|------------|-------------------------|------------|-------------------------------------|
| | | | Set coil | Reset coil | Set coil | Reset coil | Set coil | Reset coil | |
| 3V DC | 70%V or less of nominal voltage (Initial) | 70%V or less of nominal voltage (Initial) | 66.6mA | 66.6mA | 45Ω | 45Ω | 200mW | 200mW | 130%V of nominal voltage |
| 5V DC | | | 40mA | 40mA | 125Ω | 125Ω | | | |
| 6V DC | | | 33.3mA | 33.3mA | 180Ω | 180Ω | | | |
| 12V DC | | | 16.6mA | 16.6mA | 720Ω | 720Ω | | | |
| 24V DC | | | 8.3mA | 8.3mA | 2,880Ω | 2,880Ω | | | |

2. Specifications

| Characteristics | Item | Specifications | | |
|--|--|---|---|-----------------------|
| | | 1 Form A | 1 Form A 1 Form B | |
| Contact | Arrangement | | | |
| | Contact resistance (Initial) | Max. 30 mΩ (By voltage drop 6 V DC 1A) | | |
| | Contact material | Au-flashed AgSnO ₂ type | | |
| Rating | Nominal switching capacity | Resistive load | 10A 250V AC, 10A 30V DC | 8A 250V AC, 8A 30V DC |
| | | Inductive load (cosφ = 0.4, L/R = 7ms) | 5A 250V AC | 3.5A 250V AC |
| | Max. switching capacity (Reference value) | Resistive load | 2,500V A, 300W | 2,000V A, 240W |
| | | Inductive load (cosφ = 0.4, L/R = 7ms) | 1,250V A | 875V A |
| | Max. switching voltage | 380V AC, 125V DC | | |
| | Max. switching current | 10 A | 8 A | |
| | Min. switching capacity (Reference value)*1 | 5V 10mA | | |
| Nominal operating power | 200 mW | | | |
| Electrical characteristics | Insulation resistance (Initial) | Min. 1,000MΩ (at 500V DC) Measurement at same location as "Breakdown voltage" section. | | |
| | Breakdown voltage (Initial) | Between open contacts | 1,000 Vrms for 1 min. (Detection current: 10 mA) | |
| | | Between contact and coil | 4,000 Vrms for 1 min. (Detection current: 10 mA) | |
| | Surge breakdown voltage*2 (Initial) | Between contact and coil | 10,000 V | |
| | Temperature rise (coil) (at70°C 158°F) | Max. 40°C (By resistive method, nominal voltage applied to the coil; max. switching current) | | |
| | Operate time [Set time] (at 20°C 68°F) | Max. 10 ms [10 ms] (Nominal coil voltage applied to the coil, excluding contact bounce time.) | | |
| Release time [Reset time] (at 20°C 68°F) | Max. 8 ms [10 ms] (Nominal coil voltage applied to the coil, excluding contact bounce time.) (without diode) | | | |
| Mechanical characteristics | Shock resistance | Functional | Min. 98 m/s ² (Half-wave pulse of sine wave: 11 ms; detection time: 10μs.) | |
| | | Destructive | Min. 980 m/s ² (Half-wave pulse of sine wave: 6 ms.) | |
| | Vibration resistance | Functional | 10 to 55 Hz at double amplitude of 1.5 mm (Detection time: 10μs.) | |
| | | Destructive | 10 to 55 Hz at double amplitude of 3 mm | |
| Expected life | Mechanical | Min. 5×10 ⁷ (at 300 times/min.) | | |
| | Electrical | Min. 2×10 ⁵ : 1 Form A inductive load (at 20 times/min.) (at rated load); Min. 10 ⁵ : 1 Form A resistive load, 1 Form A 1 Form B resistive load, 1 Form A 1 Form B inductive load (at 20 times/min.) (at rated load) | | |
| Conditions | Conditions for operation, transport and storage*3 | Ambient temperature: -40°C to +70°C -40°F to +158°F; Humidity: 5 to 85% R.H. (Not freezing and condensing at low temperature) | | |
| | Max. operating speed (at rated load) | 20 times/min. | | |
| Unit weight | Approx. 6g .21oz | | | |

Notes: *1. This value can change due to the switching frequency, environmental conditions, and desired reliability level, therefore it is recommended to check this with the actual load.

*2. Wave is standard shock voltage of ±1.2×50μs according to JEC-212-1981

*3. The upper limit of the ambient temperature is the maximum temperature that can satisfy the coil temperature rise value. Refer to Usage, transport and storage conditions in NOTES.

DY (ADY1, 3)

REFERENCE DATA

1-(1). Maximum switching capacity
(1 Form A)
Tested sample: ADY10024

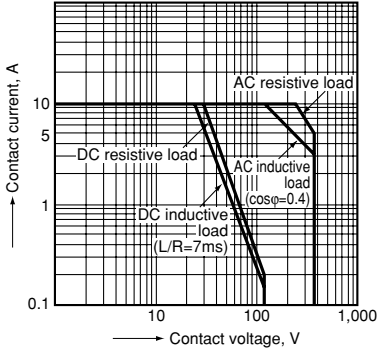

1-(2). Maximum switching capacity
(1 Form A 1 Form B)
Tested sample: ADY30024

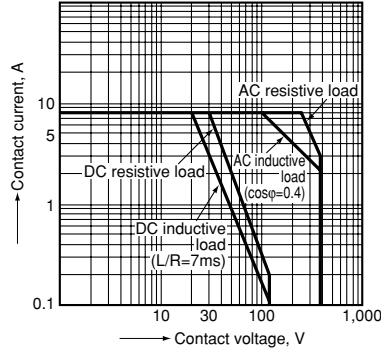

2-(1). Coil temperature rise
(1 Form A)
Tested sample: ADY10024, 6 pcs.
Ambient temperature: 20°C, 68°F

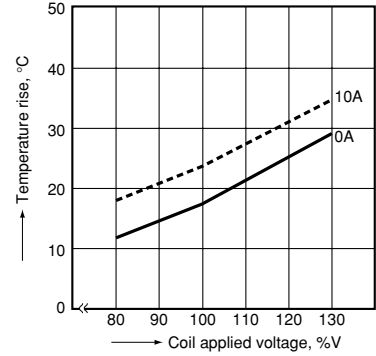

2-(2). Coil temperature rise
(1 Form A 1 Form B)
Tested sample: ADY30024, 6 pcs.
Ambient temperature: 20°C, 68°F

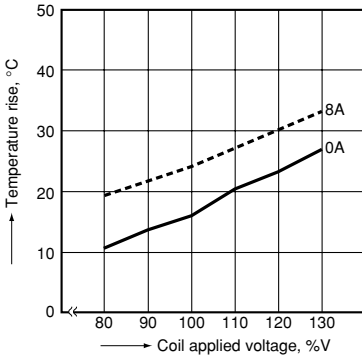

3-(1). Ambient temperature characteristics
(1 Form A)
Tested sample: ADY10024, 6 pcs.
Ambient temperature: -40°C to 70°C -40°F to 158°F

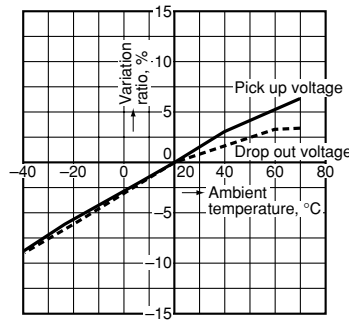

3-(2). Ambient temperature characteristics
(1 Form A 1 Form B)
Tested sample: ADY30024, 6 pcs.
Ambient temperature: -40°C to 70°C -40°F to 158°F

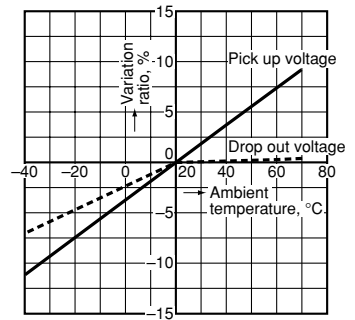

DIMENSIONS (mm inch)

The CAD data of the products with a **CAD Data** mark can be downloaded from: <http://industrial.panasonic.com/ac/e>

1. 1 Form A type

CAD Data



External dimensions
Single side stable type

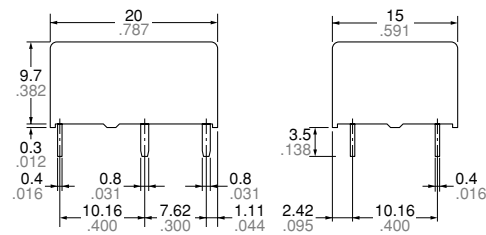

PC board pattern
(BOTTOM VIEW)
Single side stable type

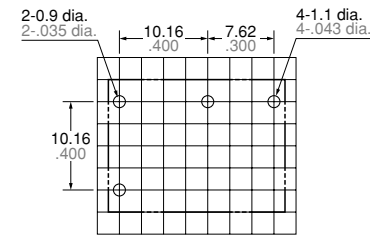

Schematic
(BOTTOM VIEW)
Single side stable

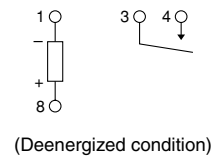

2 coil latching type

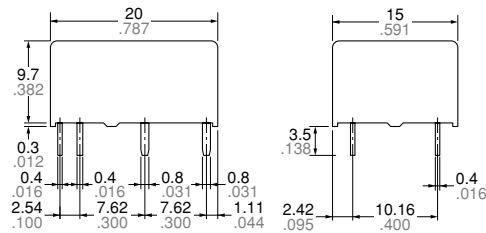

General tolerance: $\pm 0.3 \pm 0.012$

2 coil latching type

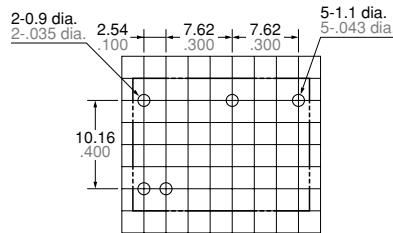

Tolerance: $\pm 0.1 \pm 0.004$

2 coil latching type

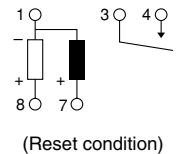

Since this is a polarized relay, the connection to the coil should be done according to the above schematic.

2. 1 Form A 1 Form B type

CAD Data



External dimensions
Single side stable type

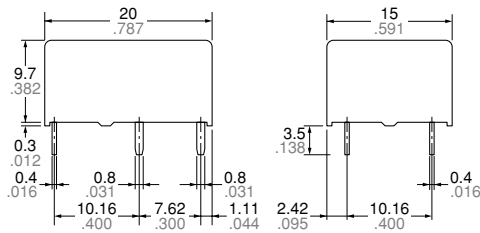

2 coil latching type

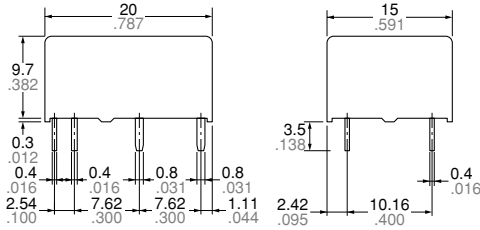

General tolerance: $\pm 0.3 \pm .012$

PC board pattern
(BOTTOM VIEW)

Single side stable type

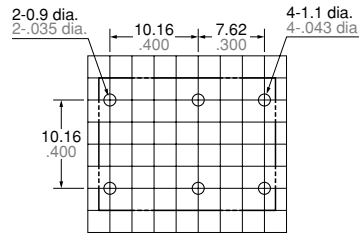

2 coil latching type

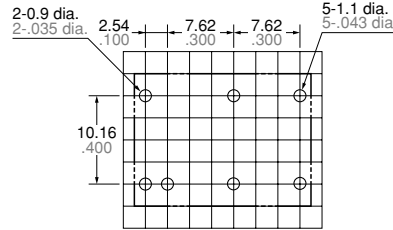

Tolerance: $\pm 0.1 \pm .004$

Schematic
(BOTTOM VIEW)

Single side stable

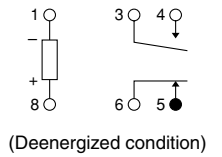

2 coil latching type

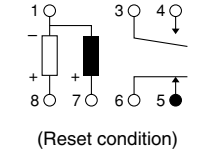

Since this is a polarized relay, the connection to the coil should be done according to the above schematic.

SAFETY STANDARDS

| Item | UL/C-UL (Recognized) | | CSA (Certified) | | TÜV (Certified) | |
|-------------------|----------------------|---|-----------------|---|----------------------|--|
| | File No. | Contact rating | File No. | Contact rating | File No. | Rating |
| 1 Form A | E43028 | 10A 250V AC 1/3HP 125, 250V AC 10A 30V DC | LR26550 etc. | 10A 250V AC 1/3HP 125, 250V AC 10A 30V DC | B 04 06 13461 038 | 10A 250V AC (cosφ=1.0) 10A 30V DC (0ms) |
| 1 Form A 1 Form B | E43028 | 8A 250V AC 1/4HP 125, 250V AC 8A 30V DC | LR26550 etc. | 8A 250V AC 1/4HP 125, 250V AC 8A 30V DC | B 04 06 13461 038 | 8A 250V AC (cosφ=1.0) 8A 30V DC (0ms) |

NOTES

1. Soldering should be done under the following conditions:

250°C 482°F within 10s

300°C 572°F within 5s

350°C 662°F within 3s

Soldering depth: 2/3 terminal pitch

2. External magnetic field

Since DY relays are highly sensitive polarized relays, their characteristics will be affected by a strong external magnetic field. Avoid using the relay under that condition.

3. When using, please be aware that the A contact and B contact sides of 1 Form A and 1 Form B types may go on simultaneously at operate time and release time.

For Cautions for Use.