

**Electrical life: Min. 2×10^5
1a 10A, 1a1b 8A small
polarized power relays**

ADY RELAYS (ADY)



RoHS compliant

FEATURES

- Compact size:**
1 Form A (10A 250V AC),
1 Form A 1 Form B (8A 250V AC)
- Latching types available**
- Compliant with IEC EN61010-1.**
Reinforced insulation with 6 mm distance between input and output.
- Electrical life of Min. 2×10^5 times (1 Form A type) realized with inductive load ($\cos\phi=0.4$, $L/R=7ms$, 5A 250V AC)**
- Sockets are available.**

TYPICAL APPLICATIONS

- Control for industrial machines (machine tools, robotics)**
- Output relays for temperature controllers, PLCs, timers, sensors.**
- Measuring equipment**
- Security equipment**

	Product name	Part No.
1 Form A	Single side stable type	DK1a-PS
	2 coil latching type	DK1a-PSL2
1 Form A 1 Form B	Single side stable type	DK2a-PS
	2 coil latching type	DK2a-PSL2

Please see "DK relay socket" for details.

ORDERING INFORMATION

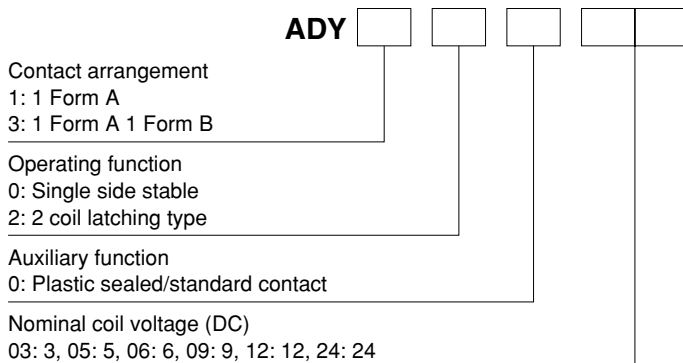

Note: Certified by UL, CSA and TÜV

TYPES

Contact arrangement	Nominal coil voltage	Single side stable	2 coil latching
		Part No.	Part No.
1 Form A	3V DC	ADY10003	ADY12003
	5V DC	ADY10005	ADY12005
	6V DC	ADY10006	ADY12006
	12V DC	ADY10012	ADY12012
	24V DC	ADY10024	ADY12024
1 Form A 1 Form B	3V DC	ADY30003	ADY32003
	5V DC	ADY30005	ADY32005
	6V DC	ADY30006	ADY32006
	12V DC	ADY30012	ADY32012
	24V DC	ADY30024	ADY32024

Standard packing: Carton: 50 pcs.; Case: 500 pcs.

* For sockets, see page 140.

RATING**1. Coil data**

1) Single side stable

Nominal coil voltage	Pick-up voltage (at 20°C 68°F)	Drop-out voltage (at 20°C 68°F)	Nominal operating current [±10%] (at 20°C 68°F)	Coil resistance [±10%] (at 20°C 68°F)	Nominal operating power	Max. applied voltage (at 20°C 68°F)
3V DC	70%V or less of nominal voltage (Initial)	10%V or more of nominal voltage (Initial)	66.6mA	45Ω	200mW	130%V of nominal voltage
5V DC			40mA	125Ω		
6V DC			33.3mA	180Ω		
12V DC			16.6mA	720Ω		
24V DC			8.3mA	2,880Ω		

2) 2 coil latching

Nominal coil voltage	Set voltage (at 20°C 68°F)	Reset voltage (at 20°C 68°F)	Nominal operating current [±10%] (at 20°C 68°F)		Coil resistance [±10%] (at 20°C 68°F)		Nominal operating power		Max. applied voltage (at 20°C 68°F)
			Set coil	Reset coil	Set coil	Reset coil	Set coil	Reset coil	
3V DC	70%V or less of nominal voltage (Initial)	70%V or less of nominal voltage (Initial)	66.6mA	66.6mA	45Ω	45Ω	200mW	200mW	130%V of nominal voltage
5V DC			40mA	40mA	125Ω	125Ω			
6V DC			33.3mA	33.3mA	180Ω	180Ω			
12V DC			16.6mA	16.6mA	720Ω	720Ω			
24V DC			8.3mA	8.3mA	2,880Ω	2,880Ω			

2. Specifications

Characteristics	Item	Specifications		
		1 Form A	1 Form A 1 Form B	
Contact	Arrangement			
	Contact resistance (Initial)	Max. 30 mΩ (By voltage drop 6 V DC 1A)		
	Contact material	Au-flashed AgSnO ₂ type		
Rating	Nominal switching capacity	Resistive load	10A 250V AC, 10A 30V DC	8A 250V AC, 8A 30V DC
		Inductive load (cosφ = 0.4, L/R = 7ms)	5A 250V AC	3.5A 250V AC
	Max. switching capacity (Reference value)	Resistive load	2,500V A, 300W	2,000V A, 240W
		Inductive load (cosφ = 0.4, L/R = 7ms)	1,250V A	875V A
	Max. switching voltage	380V AC, 125V DC		
	Max. switching current	10 A	8 A	
	Min. switching capacity (Reference value)*1	5V 10mA		
Nominal operating power	200 mW			
Electrical characteristics	Insulation resistance (Initial)	Min. 1,000MΩ (at 500V DC) Measurement at same location as "Breakdown voltage" section.		
	Breakdown voltage (Initial)	Between open contacts	1,000 Vrms for 1 min. (Detection current: 10 mA)	
		Between contact and coil	4,000 Vrms for 1 min. (Detection current: 10 mA)	
	Surge breakdown voltage*2 (Initial)	Between contact and coil	10,000 V	
	Temperature rise (coil) (at70°C 158°F)	Max. 40°C (By resistive method, nominal voltage applied to the coil; max. switching current)		
	Operate time [Set time] (at 20°C 68°F)	Max. 10 ms [10 ms] (Nominal coil voltage applied to the coil, excluding contact bounce time.)		
Release time [Reset time] (at 20°C 68°F)	Max. 8 ms [10 ms] (Nominal coil voltage applied to the coil, excluding contact bounce time.) (without diode)			
Mechanical characteristics	Shock resistance	Functional	Min. 98 m/s ² (Half-wave pulse of sine wave: 11 ms; detection time: 10μs.)	
		Destructive	Min. 980 m/s ² (Half-wave pulse of sine wave: 6 ms.)	
	Vibration resistance	Functional	10 to 55 Hz at double amplitude of 1.5 mm (Detection time: 10μs.)	
		Destructive	10 to 55 Hz at double amplitude of 3 mm	
Expected life	Mechanical	Min. 5×10 ⁷ (at 300 times/min.)		
	Electrical	Min. 2×10 ⁵ : 1 Form A inductive load (at 20 times/min.) (at rated load); Min. 10 ⁵ : 1 Form A resistive load, 1 Form A 1 Form B resistive load, 1 Form A 1 Form B inductive load (at 20 times/min.) (at rated load)		
Conditions	Conditions for operation, transport and storage*3	Ambient temperature: -40°C to +70°C -40°F to +158°F; Humidity: 5 to 85% R.H. (Not freezing and condensing at low temperature)		
	Max. operating speed (at rated load)	20 times/min.		
Unit weight	Approx. 6g .21oz			

Notes: *1. This value can change due to the switching frequency, environmental conditions, and desired reliability level, therefore it is recommended to check this with the actual load.

*2. Wave is standard shock voltage of ±1.2×50μs according to JEC-212-1981

*3. The upper limit of the ambient temperature is the maximum temperature that can satisfy the coil temperature rise value. Refer to Usage, transport and storage conditions in NOTES.

DY (ADY1, 3)

REFERENCE DATA

1-(1). Maximum switching capacity
(1 Form A)
Tested sample: ADY10024

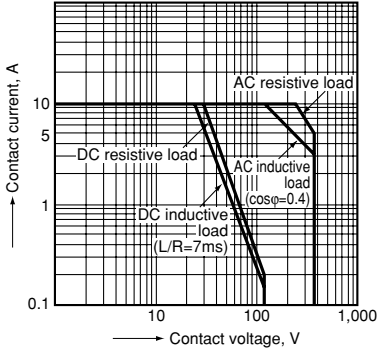

1-(2). Maximum switching capacity
(1 Form A 1 Form B)
Tested sample: ADY30024

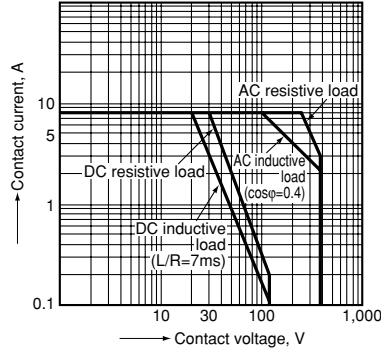

2-(1). Coil temperature rise
(1 Form A)
Tested sample: ADY10024, 6 pcs.
Ambient temperature: 20°C, 68°F

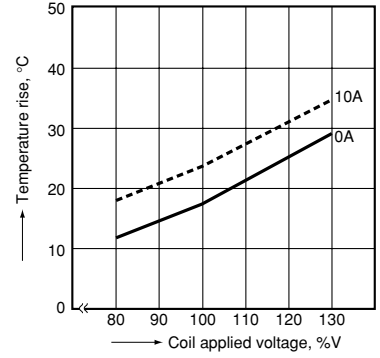

2-(2). Coil temperature rise
(1 Form A 1 Form B)
Tested sample: ADY30024, 6 pcs.
Ambient temperature: 20°C, 68°F

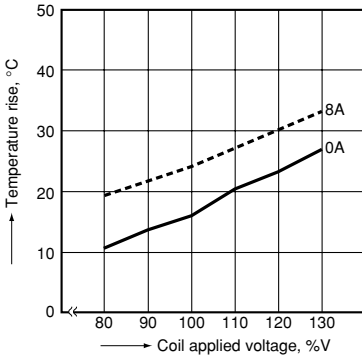

3-(1). Ambient temperature characteristics
(1 Form A)
Tested sample: ADY10024, 6 pcs.
Ambient temperature: -40°C to 70°C -40°F to 158°F

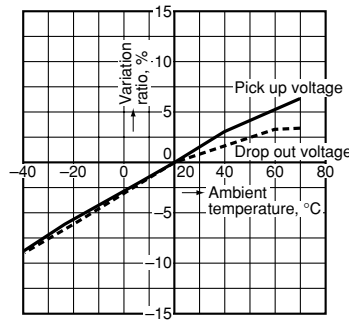

3-(2). Ambient temperature characteristics
(1 Form A 1 Form B)
Tested sample: ADY30024, 6 pcs.
Ambient temperature: -40°C to 70°C -40°F to 158°F

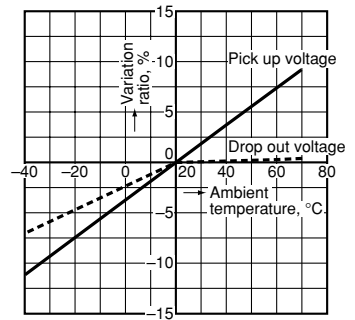

DIMENSIONS (mm inch)

The CAD data of the products with a **CAD Data** mark can be downloaded from: <http://industrial.panasonic.com/ac/e>

1. 1 Form A type

CAD Data



External dimensions
Single side stable type

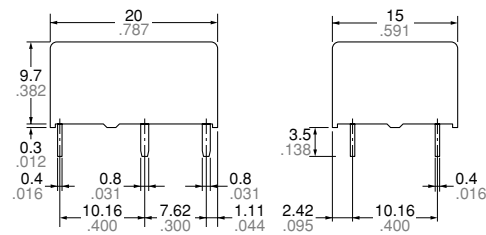

PC board pattern
(BOTTOM VIEW)
Single side stable type

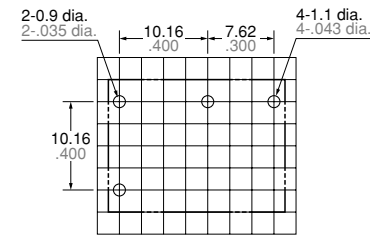

Schematic
(BOTTOM VIEW)
Single side stable

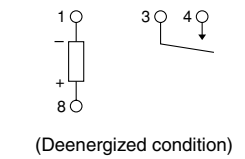

2 coil latching type

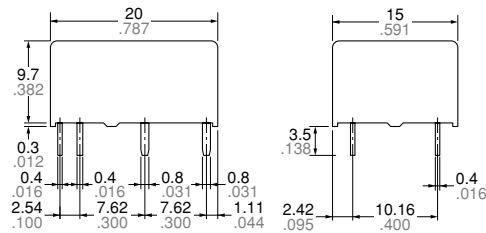

General tolerance: $\pm 0.3 \pm 0.012$

2 coil latching type

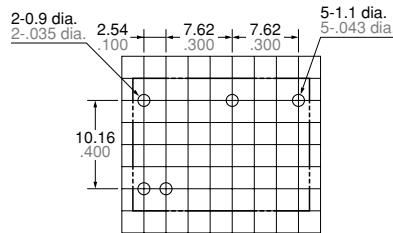

Tolerance: $\pm 0.1 \pm 0.004$

2 coil latching type

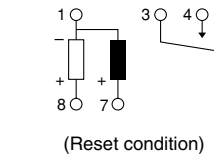

Since this is a polarized relay, the connection to the coil should be done according to the above schematic.

2. 1 Form A 1 Form B type

CAD Data



External dimensions

Single side stable type

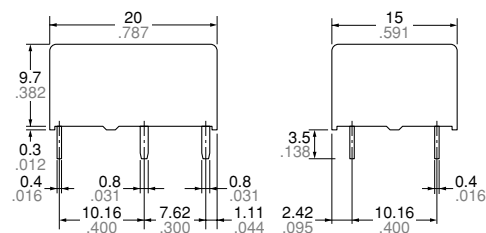

2 coil latching type

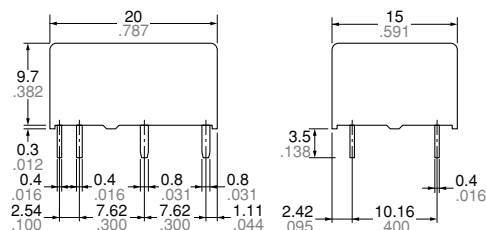

General tolerance: $\pm 0.3 \pm .012$

PC board pattern (BOTTOM VIEW)

Single side stable type

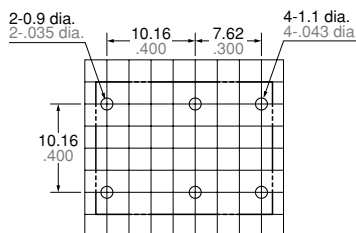

2 coil latching type

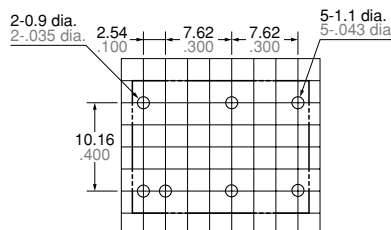

Tolerance: $\pm 0.1 \pm .004$

Schematic (BOTTOM VIEW)

Single side stable

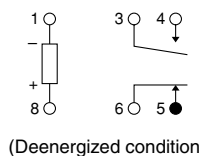

(Deenergized condition)

2 coil latching type

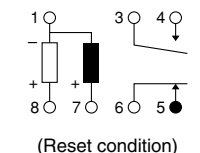

(Reset condition)

Since this is a polarized relay, the connection to the coil should be done according to the above schematic.

SAFETY STANDARDS

Item	UL/C-UL (Recognized)		CSA (Certified)		TÜV (Certified)	
	File No.	Contact rating	File No.	Contact rating	File No.	Rating
1 Form A	E43028	10A 250V AC 1/3HP 125, 250V AC 10A 30V DC	LR26550 etc.	10A 250V AC 1/3HP 125, 250V AC 10A 30V DC	B 04 06 13461 038	10A 250V AC (cosφ=1.0) 10A 30V DC (0ms)
1 Form A 1 Form B	E43028	8A 250V AC 1/4HP 125, 250V AC 8A 30V DC	LR26550 etc.	8A 250V AC 1/4HP 125, 250V AC 8A 30V DC	B 04 06 13461 038	8A 250V AC (cosφ=1.0) 8A 30V DC (0ms)

NOTES

1. Soldering should be done under the following conditions:

250°C 482°F within 10s

300°C 572°F within 5s

350°C 662°F within 3s

Soldering depth: 2/3 terminal pitch

2. External magnetic field

Since DY relays are highly sensitive polarized relays, their characteristics will be affected by a strong external magnetic field. Avoid using the relay under that condition.

3. When using, please be aware that the A contact and B contact sides of 1 Form A and 1 Form B types may go on simultaneously at operate time and release time.

For Cautions for Use.