

Electrical life: Min.  $2 \times 10^5$   
1a 10A, 1a1b 8A small  
polarized power relays

## ADY RELAYS (ADY)



RoHS compliant

### FEATURES

1. Compact size:  
1 Form A (10A 250V AC),  
1 Form A 1 Form B (8A 250V AC)
2. Latching types available
3. Compliant with IEC EN61010-1.  
Reinforced insulation with 6 mm  
distance between input and output.
4. Electrical life of Min.  $2 \times 10^5$  times  
(1 Form A type) realized with  
inductive load ( $\cos\phi=0.4$ , L/R=7ms,  
5A 250V AC)
5. Sockets are available.

	Product name	Part No.
1 Form A	Single side stable type	DK1a-PS
	2 coil latching type	DK1a-PSL2
1 Form A 1 Form B	Single side stable type	DK2a-PS
	2 coil latching type	DK2a-PSL2

Please see "DK relay socket" for details.

### TYPICAL APPLICATIONS

1. Control for industrial machines  
(machine tools, robotics)
2. Output relays for temperature  
controllers, PLCs, timers, sensors.
3. Measuring equipment
4. Security equipment

## ORDERING INFORMATION

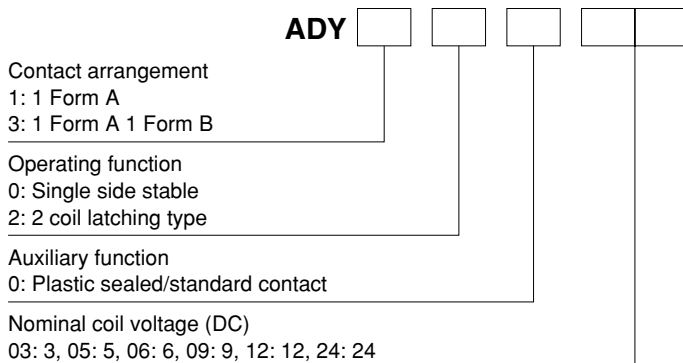

Note: Certified by UL, CSA and TÜV

## TYPES

Contact arrangement	Nominal coil voltage	Single side stable		2 coil latching	
		Part No.		Part No.	
1 Form A	3V DC	ADY10003		ADY12003	
	5V DC	ADY10005		ADY12005	
	6V DC	ADY10006		ADY12006	
	12V DC	ADY10012		ADY12012	
	24V DC	ADY10024		ADY12024	
1 Form A 1 Form B	3V DC	ADY30003		ADY32003	
	5V DC	ADY30005		ADY32005	
	6V DC	ADY30006		ADY32006	
	12V DC	ADY30012		ADY32012	
	24V DC	ADY30024		ADY32024	

Standard packing: Carton: 50 pcs.; Case: 500 pcs.

\* For sockets, see page 140.

**RATING****1. Coil data**

## 1) Single side stable

Nominal coil voltage	Pick-up voltage (at 20°C 68°F)	Drop-out voltage (at 20°C 68°F)	Nominal operating current [ $\pm 10\%$ ] (at 20°C 68°F)	Coil resistance [ $\pm 10\%$ ] (at 20°C 68°F)	Nominal operating power	Max. applied voltage (at 20°C 68°F)
3V DC	70%V or less of nominal voltage (Initial)	10%V or more of nominal voltage (Initial)	66.6mA	45 $\Omega$	200mW	130%V of nominal voltage
5V DC			40mA	125 $\Omega$		
6V DC			33.3mA	180 $\Omega$		
12V DC			16.6mA	720 $\Omega$		
24V DC			8.3mA	2,880 $\Omega$		

## 2) 2 coil latching

Nominal coil voltage	Set voltage (at 20°C 68°F)	Reset voltage (at 20°C 68°F)	Nominal operating current [ $\pm 10\%$ ] (at 20°C 68°F)		Coil resistance [ $\pm 10\%$ ] (at 20°C 68°F)		Nominal operating power		Max. applied voltage (at 20°C 68°F)
			Set coil	Reset coil	Set coil	Reset coil	Set coil	Reset coil	
3V DC	70%V or less of nominal voltage (Initial)	70%V or less of nominal voltage (Initial)	66.6mA	66.6mA	45 $\Omega$	45 $\Omega$	200mW	200mW	130%V of nominal voltage
5V DC			40mA	40mA	125 $\Omega$	125 $\Omega$			
6V DC			33.3mA	33.3mA	180 $\Omega$	180 $\Omega$			
12V DC			16.6mA	16.6mA	720 $\Omega$	720 $\Omega$			
24V DC			8.3mA	8.3mA	2,880 $\Omega$	2,880 $\Omega$			

**2. Specifications**

Characteristics	Item	Specifications		
		1 Form A	1 Form A 1 Form B	
Contact	Arrangement			
	Contact resistance (Initial)	Max. 30 m $\Omega$ (By voltage drop 6 V DC 1A)		
	Contact material	Au-flashed AgSnO <sub>2</sub> type		
Rating	Nominal switching capacity	Resistive load	10A 250V AC, 10A 30V DC	8A 250V AC, 8A 30V DC
		Inductive load (cos $\phi$ = 0.4, L/R = 7ms)	5A 250V AC	3.5A 250V AC
	Max. switching capacity (Reference value)	Resistive load	2,500V A, 300W	2,000V A, 240W
		Inductive load (cos $\phi$ = 0.4, L/R = 7ms)	1,250V A	875V A
	Max. switching voltage	380V AC, 125V DC		
	Max. switching current	10 A	8 A	
	Min. switching capacity (Reference value)*1	5V 10mA		
Nominal operating power	200 mW			
Electrical characteristics	Insulation resistance (Initial)	Min. 1,000M $\Omega$ (at 500V DC) Measurement at same location as "Breakdown voltage" section.		
	Breakdown voltage (Initial)	Between open contacts	1,000 Vrms for 1 min. (Detection current: 10 mA)	
		Between contact and coil	4,000 Vrms for 1 min. (Detection current: 10 mA)	
	Surge breakdown voltage*2 (Initial)	Between contact and coil	10,000 V	
	Temperature rise (coil) (at 70°C 158°F)	Max. 40°C (By resistive method, nominal voltage applied to the coil; max. switching current)		
	Operate time [Set time] (at 20°C 68°F)	Max. 10 ms [10 ms] (Nominal coil voltage applied to the coil, excluding contact bounce time.)		
Release time [Reset time] (at 20°C 68°F)	Max. 8 ms [10 ms] (Nominal coil voltage applied to the coil, excluding contact bounce time.) (without diode)			
Mechanical characteristics	Shock resistance	Functional	Min. 98 m/s <sup>2</sup> (Half-wave pulse of sine wave: 11 ms; detection time: 10 $\mu$ s.)	
		Destructive	Min. 980 m/s <sup>2</sup> (Half-wave pulse of sine wave: 6 ms.)	
	Vibration resistance	Functional	10 to 55 Hz at double amplitude of 1.5 mm (Detection time: 10 $\mu$ s.)	
		Destructive	10 to 55 Hz at double amplitude of 3 mm	
Expected life	Mechanical	Min. 5 $\times 10^7$ (at 300 times/min.)		
	Electrical	Min. 2 $\times 10^5$ : 1 Form A inductive load (at 20 times/min.) (at rated load); Min. 10 <sup>5</sup> : 1 Form A resistive load, 1 Form A 1 Form B resistive load, 1 Form A 1 Form B inductive load (at 20 times/min.) (at rated load)		
Conditions	Conditions for operation, transport and storage*3	Ambient temperature: -40°C to +70°C -40°F to +158°F; Humidity: 5 to 85% R.H. (Not freezing and condensing at low temperature)		
	Max. operating speed (at rated load)	20 times/min.		
Unit weight	Approx. 6g .21oz			

Notes: \*1. This value can change due to the switching frequency, environmental conditions, and desired reliability level, therefore it is recommended to check this with the actual load.

\*2. Wave is standard shock voltage of  $\pm 1.2 \times 50\mu$ s according to JEC-212-1981

\*3. The upper limit of the ambient temperature is the maximum temperature that can satisfy the coil temperature rise value. Refer to Usage, transport and storage conditions in NOTES.

# DY (ADY1, 3)

## REFERENCE DATA

1-(1). Maximum switching capacity  
(1 Form A)  
Tested sample: ADY10024

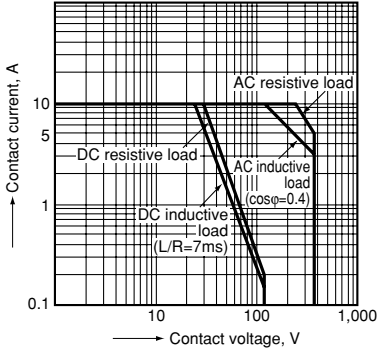

1-(2). Maximum switching capacity  
(1 Form A 1 Form B)  
Tested sample: ADY30024

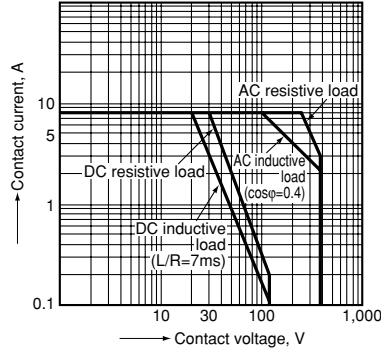

2-(1). Coil temperature rise  
(1 Form A)  
Tested sample: ADY10024, 6 pcs.  
Ambient temperature: 20°C, 68°F

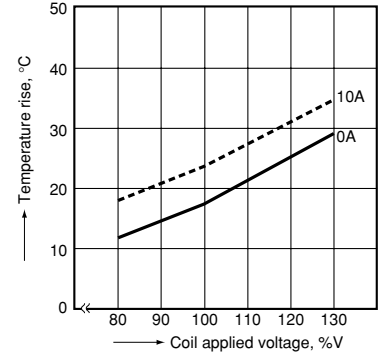

2-(2). Coil temperature rise  
(1 Form A 1 Form B)  
Tested sample: ADY30024, 6 pcs.  
Ambient temperature: 20°C, 68°F

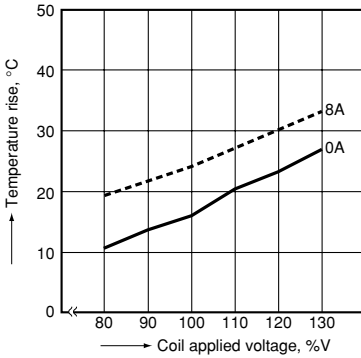

3-(1). Ambient temperature characteristics  
(1 Form A)  
Tested sample: ADY10024, 6 pcs.  
Ambient temperature: -40°C to 70°C -40°F to 158°F

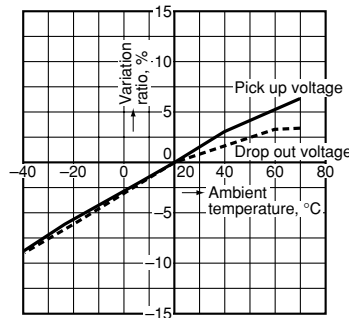

3-(2). Ambient temperature characteristics  
(1 Form A 1 Form B)  
Tested sample: ADY30024, 6 pcs.  
Ambient temperature: -40°C to 70°C -40°F to 158°F

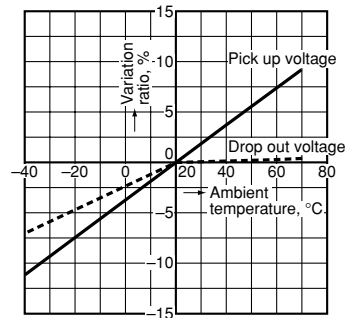

## DIMENSIONS (mm inch)

The CAD data of the products with a **CAD Data** mark can be downloaded from: <http://industrial.panasonic.com/ac/e>

### 1. 1 Form A type

**CAD Data**



External dimensions  
Single side stable type

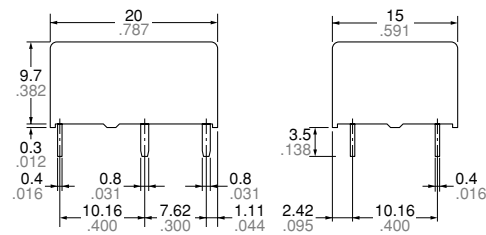

PC board pattern  
(BOTTOM VIEW)

Single side stable type

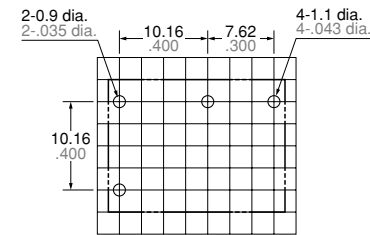

Schematic  
(BOTTOM VIEW)

Single side stable

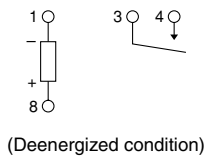

2 coil latching type

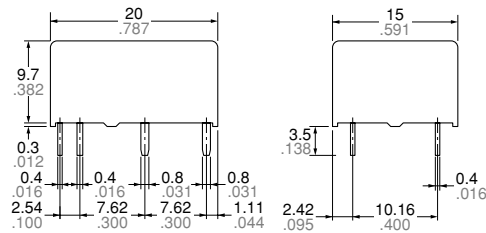

General tolerance:  $\pm 0.3 \pm 0.012$

2 coil latching type

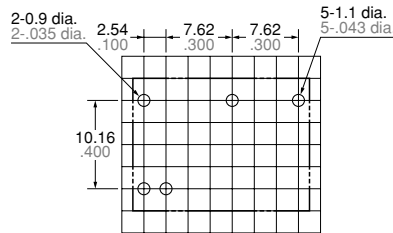

Tolerance:  $\pm 0.1 \pm 0.004$

2 coil latching type

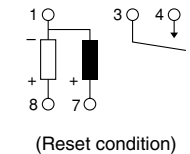

Since this is a polarized relay, the connection to the coil should be done according to the above schematic.

2. 1 Form A 1 Form B type

CAD Data



External dimensions

Single side stable type

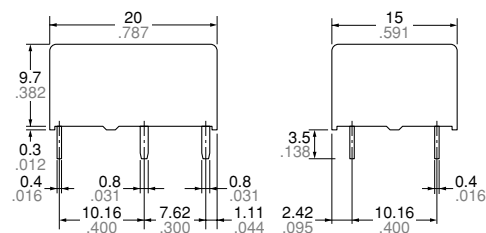

2 coil latching type

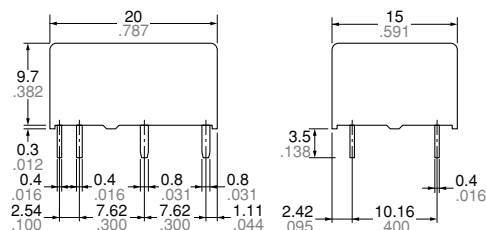

General tolerance:  $\pm 0.3 \pm .012$

PC board pattern (BOTTOM VIEW)

Single side stable type

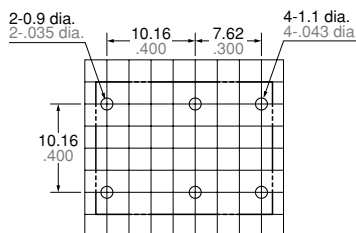

2 coil latching type

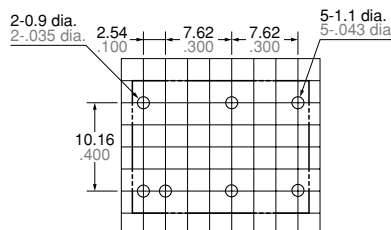

Tolerance:  $\pm 0.1 \pm .004$

Schematic (BOTTOM VIEW)

Single side stable

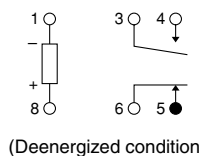

(Deenergized condition)

2 coil latching type

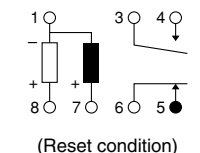

(Reset condition)

Since this is a polarized relay, the connection to the coil should be done according to the above schematic.

SAFETY STANDARDS

Item	UL/C-UL (Recognized)		CSA (Certified)		TÜV (Certified)	
	File No.	Contact rating	File No.	Contact rating	File No.	Rating
1 Form A	E43028	10A 250V AC 1/3HP 125, 250V AC 10A 30V DC	LR26550 etc.	10A 250V AC 1/3HP 125, 250V AC 10A 30V DC	B 04 06 13461 038	10A 250V AC (cosφ=1.0) 10A 30V DC (0ms)
1 Form A 1 Form B	E43028	8A 250V AC 1/4HP 125, 250V AC 8A 30V DC	LR26550 etc.	8A 250V AC 1/4HP 125, 250V AC 8A 30V DC	B 04 06 13461 038	8A 250V AC (cosφ=1.0) 8A 30V DC (0ms)

NOTES

1. Soldering should be done under the following conditions:

250°C 482°F within 10s

300°C 572°F within 5s

350°C 662°F within 3s

Soldering depth: 2/3 terminal pitch

2. External magnetic field

Since DY relays are highly sensitive polarized relays, their characteristics will be affected by a strong external magnetic field. Avoid using the relay under that condition.

3. When using, please be aware that the A contact and B contact sides of 1 Form A and 1 Form B types may go on simultaneously at operate time and release time.

For Cautions for Use.