



RoHS compliant

FEATURES

• Compact flat type

Flat size enables it to be built-in switch units.

<Height>

PC board terminal type:

9.5 mm .374 inch

Surface-mount terminal type:

10.5mm .413inch

• High capacity

CP Relay provides low profile spacesaving advantages while offering high continuous current of 25A (1 hour).

• Simple footprint pattern enables ease of PC board layout

Arrangement of coil and contact terminals designed to withstand large capacity which ensures leeway and facilitates PC board design.

• Sealed construction

Sealed construction suitable for harsh environments

• “PC board terminal” and “Surface mount terminal” types available

SMD automatic mounting is possible for surface mount terminal types because tape and reel packaging is used.

• Model available for wiper load.

TYPICAL APPLICATIONS

For automotive system

Power windows, Auto door lock, Power sunroof, Memory seat, Wiper, Defogger, etc.

ORDERING INFORMATION

CP □ - □ - □ - □

Contact arrangement

1: 1 Form C

1a: 1 Form A

1W: 1 Form C for wiper load

Mounting classification

Nil: PC board terminal/wiper load

SA: Surface-mount terminal*1

Coil voltage (DC)

12 V

Packing style*2

Nil: Tube packing

X: Tape and reel packing (picked from the NC terminal side)

Z: Tape and reel packing (picked from the coil terminal side)

TYPES

1. PC board terminal type

Contact arrangement	Coil voltage	Part No.
1 Form A	12V DC	CP1a-12V
1 Form C		CP1-12V
1 Form C for wiper load		CP1W-12V

Standard packing; Carton (tube): 40 pcs.; Case: 1,000 pcs.

2. Surface mount terminal type

Contact arrangement	Coil voltage	Part No.
1 Form C	12V DC	CP1SA-12V-X
		CP1SA-12V-Z

Standard packing; Carton (tape and reel): 300 pcs.; Case: 900 pcs.

Notes: *1. Surface-mount terminal type is available only for 1 form C contact arrangement.

*2. Surface mount terminal type is only supplied in tape and reel packaging. Tube packaging is only available for PC board type. Tape and reel packing symbol “-z” or “-x” are not marked on the relay.

RATING

1. Coil data

Nominal coil voltage	Pick-up voltage (at 20°C 68°F)	Drop-out voltage (at 20°C 68°F)	Nominal operating current [$\pm 10\%$] (at 20°C 68°F)	Coil resistance [$\pm 10\%$] (at 20°C 68°F)	Nominal operating power (at 20°C 68°F)	Usable voltage range (at 85°C 185°F)
12V DC	Max. 7.2V DC (Initial)	Min. 1.0V DC (Initial)	53.3 mA	225 Ω	640 mW	10 to 16V DC

Note: Other pick-up voltage types are also available. Please contact us for details.

2. Specifications

1) Standard CP relay

Characteristics	Item	Specifications	
		1 Form A	1 Form C
Contact	Arrangement		
	Contact resistance (Initial)	N.O.: Typ6m Ω , N.C.: Typ8m Ω (By voltage drop 6V DC 1A)	
	Contact material	Ag alloy (Cadmium free)	
Rating	Nominal switching capacity (resistive load)	20A 14V DC	N.O.: 20A 14V DC, N.C.: 10A 14V DC
	Max. carrying current (12V DC initial)* ³	N.O.: 40A for 2 minutes, 30A for 1 hour (at 20°C 68°F) 35A for 2 minutes, 25A for 1 hour (at 85°C 185°F)	
	Nominal operating power	640 mW	
	Min. switching capacity (resistive load)* ¹	1A 14V DC	
Electrical characteristics	Insulation resistance (Initial)	Min. 100 M Ω (at 500V DC, Measurement at same location as "Breakdown voltage" section.)	
	Breakdown voltage (Initial)	Between open contacts	500 Vrms for 1 min. (Detection current: 10mA)
		Between contacts and coil	500 Vrms for 1 min. (Detection current: 10mA)
	Operate time (at nominal voltage)	Max. 10ms (at 20°C 68°F, excluding contact bounce time) (Initial)	
	Release time (at nominal voltage)	Max. 10ms (at 20°C 68°F, excluding contact bounce time) (Initial)	
Mechanical characteristics	Shock resistance	Functional	Min. 100 m/s ² {10G} (Half-wave pulse of sine wave: 11ms; detection time: 10 μ s)
		Destructive	Min. 1,000 m/s ² {100G} (Half-wave pulse of sine wave: 6ms)
	Vibration resistance	Functional	10 Hz to 100 Hz, Min. 44.1 m/s ² {4.5G} (Detection time: 10 μ s)
		Destructive	10 Hz to 500 Hz, Min. 44.1 m/s ² {4.5G} Time of vibration for each direction; X, Y direction: 2 hours, Z direction: 4 hours
Expected life	Mechanical	Min. 10 ⁷ (at 120 cpm)	
	Electrical* ⁴	<Resistive load> Min. 10 ⁵ (At nominal switching capacity, operating frequency: 1s ON, 9s OFF) <Motor load> Min. 2 \times 10 ⁵ (N.O. side, Inrush 25A, steady 5A at 14V DC) Min. 10 ⁵ (N.O. side, 20A 14V DC at motor lock) Min. 2 \times 10 ⁵ (N.C. side, 20A 14V DC at brake current) (Operating frequency: 0.5s ON, 9.5s OFF)	
Conditions	Conditions for operation, transport and storage* ²	Ambient temp: -40°C to +85°C -40°F to +185°F Humidity: 5% R.H. to 85% R.H. (Not freezing and condensing at low temperature)	
	Max. operating speed	6 cpm (at rated load)	
Mass		Approx. 4g .14 oz	

Notes: *1. This value can change due to the switching frequency, environmental conditions, and desired reliability level, therefore it is recommended to check this with the actual load.

*2. The upper operation ambient temperature limit is the maximum temperature that can satisfy the coil temperature rise value. Please refer to "Usage ambient condition" in CAUTIONS FOR USE OF AUTOMOTIVE RELAYS.

Please inquire if you will be using the relay in a high temperature atmosphere (110°C 230°F).

*3. Depends on connection conditions. Also, this does not guarantee repeated switching. We recommend that you confirm operation under actual conditions.

*4. Motor load does not apply to wiper load applications.

2) For wiper load (CP1W-12V)

Anything outside of that given below complies with standard CP relays.

Characteristics	Item	Specifications
Rating	Max. carrying current (12V DC initial)* ¹	N.O.: 25A for 1 minutes, 15A for 1 hour (at 20°C 68°F)
Expected life	Electrical	<Wiper motor load (L = Approx. 1mH)> N.O. side: Min. 5 \times 10 ⁵ (Inrush 25A, steady 6A at 14V DC) N.C. side: Min. 5 \times 10 ⁵ (12A 14V DC at brake current) (Operating frequency: 1s ON, 9s OFF)

Note: *1. Depends on connection conditions. Also, this does not guarantee repeated switching. We recommend that you confirm operation under actual conditions.

REFERENCE DATA

1.-(1) Coil temperature rise (at room temperature)

Sample: CP1-12V, 3pcs
 Point measured: Inside the coil
 Contact carrying current, 5A, 10A, 15A, 20A
 Resistance method, ambient temperature 26°C 79°F

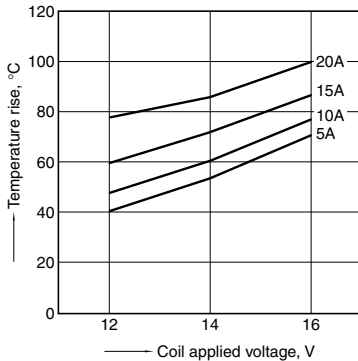

1.-(2) Coil temperature rise (85°C 185°F)

Sample: CP1-12V, 6pcs
 Point measured: Inside the coil
 Contact carrying current, 5A, 10A, 15A, 20A
 Resistance method, ambient temperature 85°C 185°F

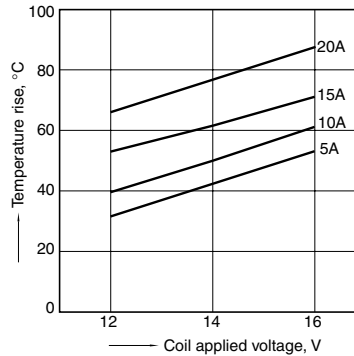

2. Max. switching capability (Resistive load, Initial)

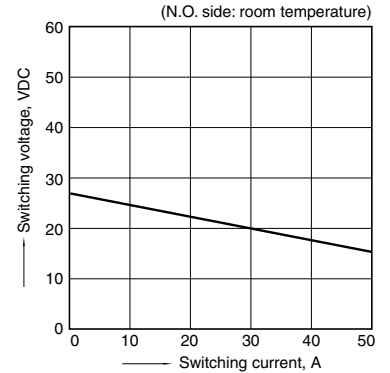

3. Ambient temperature and operating voltage range

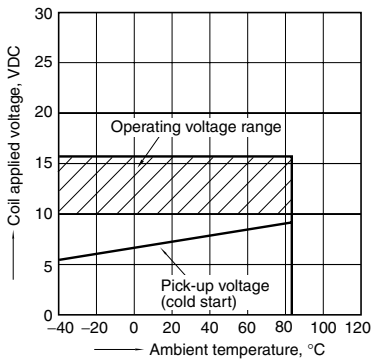

4. Distribution of pick-up and drop-out voltage

Sample: CP1-12V, 100pcs
 Ambient temperature: 20°C 68°F

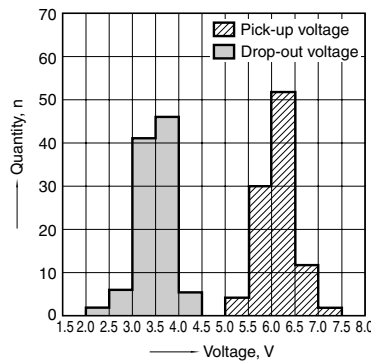

5. Distribution of operate time

Sample: CP1-12V, 100pcs
 Ambient temperature: 20°C 68°F

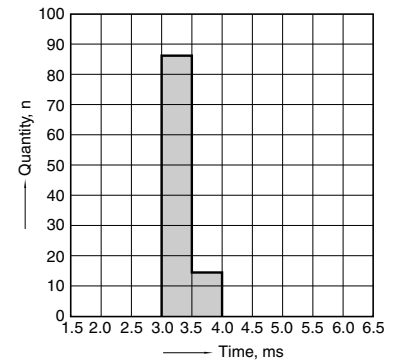

6. Distribution of release time

Sample: CP1-12V, 100pcs
 Ambient temperature: 20°C 68°F

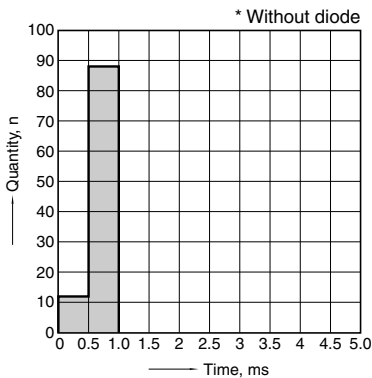

7.-(1) Electrical life test (at resistive load)

Sample: CP1-12V
 Quantity: n = 4 (N.C. = 2, N.O. = 2)
 Load: Resistive load (N.C. side: 10A 14V DC, N.O. side: 20A 14V DC)
 Operating frequency: ON 1s, OFF 9s
 Ambient temperature: Room temperature

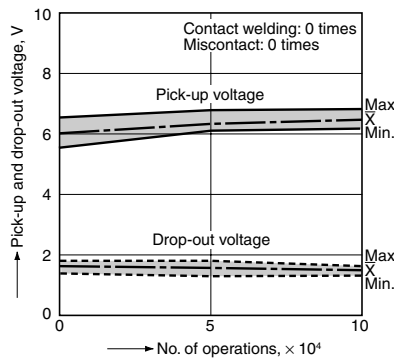

7.-(2) Electrical life test for wiper load (motor free)

Sample: CP1W-12V
 Quantity: n = 5
 Load: N.O. side: Inrush 25A, steady 6A 14V DC
 Load: N.C. side: Brake current 12A 14V DC
 Operating frequency: ON 1s, OFF 9s
 Ambient temperature: Room temperature
 Circuit

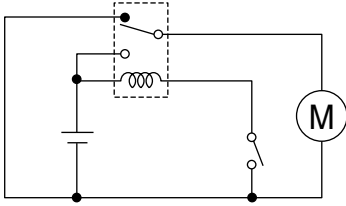

Change of pick-up and drop-out voltage

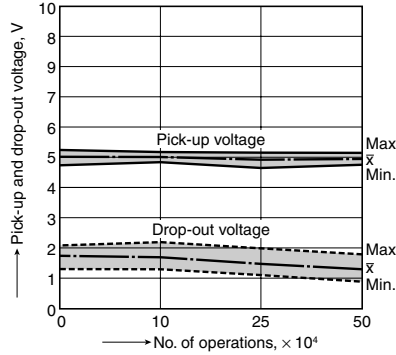

Change of contact resistance

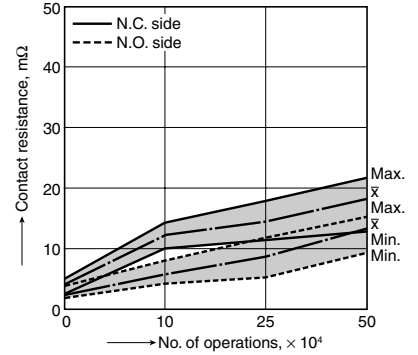

DIMENSIONS (mm inch)

The CAD data of the products with a **CAD Data** mark can be downloaded from: <http://industrial.panasonic.com/ac/e/>

1. PC board terminal type

CAD Data



External dimensions

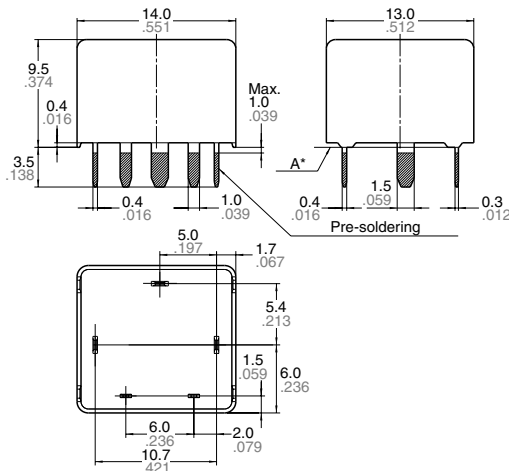

Dimension:	Tolerance
Max. 1mm .039 inch:	$\pm 0.1 \pm 0.004$
1 to 3mm .039 to .118 inch:	$\pm 0.2 \pm 0.008$
Min. 3mm .118 inch:	$\pm 0.3 \pm 0.012$

PC board pattern (Bottom view)

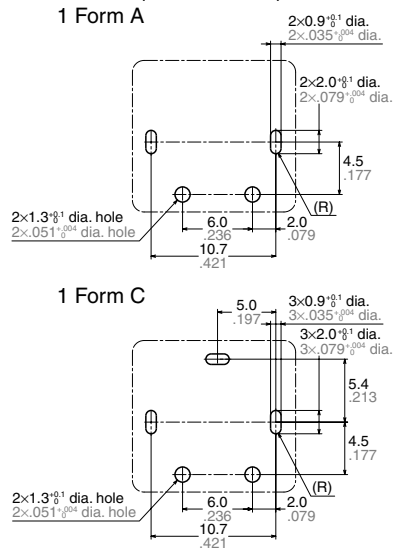

Schematic (Bottom view)

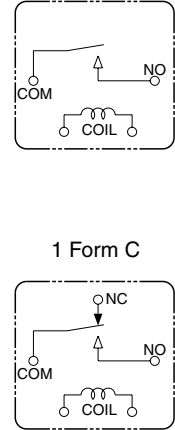

Tolerance: $\pm 0.1 \pm 0.004$

* Dimensions (thickness and width) of terminal specified in this catalog is measured before pre-soldering. Intervals between terminals is measured at A surface level.

2. Surface mount terminal type

CAD Data



External dimensions

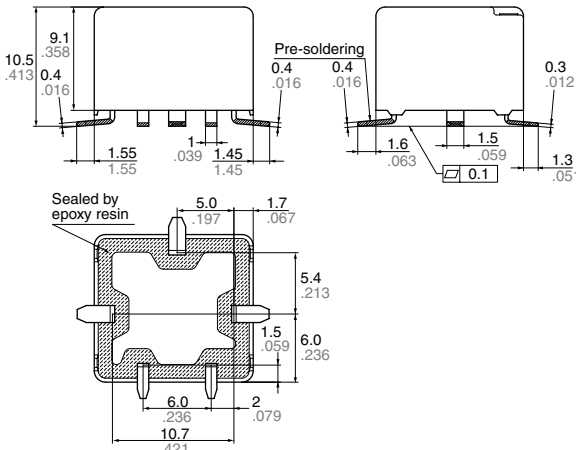

Dimension:	Tolerance
Max. 1mm .039 inch:	$\pm 0.1 \pm 0.004$
1 to 3mm .039 to .118 inch:	$\pm 0.2 \pm 0.008$
Min. 3mm .118 inch:	$\pm 0.3 \pm 0.012$

Recommendable mounting pad (Top view)

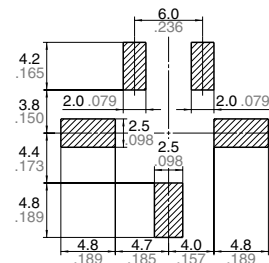

Tolerance: $\pm 0.1 \pm 0.004$

Schematic (Top view)

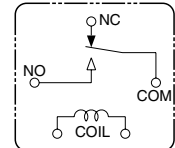

NOTES

1. Mounting and cleaning conditions for SMT type relays

- 1) Recommended reflow condition is:
 • Reflow-soldering temperature profile condition (IRS method)

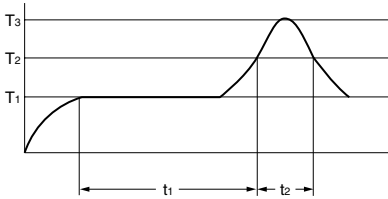

$T_1 = 150 \text{ to } 180^\circ\text{C}$ 302 to 356°F
 $T_2 = 230^\circ\text{C}$ 446°F or more
 $T_3 = \text{Less than } 260^\circ\text{C}$ 500°F
 $t_1 = 60 \text{ to } 120 \text{ sec.}$
 $t_2 = \text{Less than } 40 \text{ sec.}$

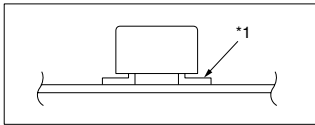

• Cautions for mounting operations

Temperature profile indicates the temperature of the soldered part (*1) of terminals on the surface of a circuit board. The exterior temperature of a relay may be extremely high depending on the component density on the board or the heating method of the reflow oven or circuit board type. Sufficient verification under actual processing conditions is required.

- 2) Avoid cleaning (ultrasonic cleaning, boiling cleaning, etc.) and coating in order to prevent negative impacts on relay characteristics.

2. Storage condition after opening a moisture-prevention package

- 1) After opening a moisture-prevention package, use the item as soon as possible (within 3 days under an environment of Max. 30°C 86°F, Max. 70% RH).
 2) If products are not used within 4 days after opening a moisture-prevention package, store them in a humidity-controlled desiccator or in a storage bag with silica gel.

For general cautions for use, please refer to the “CAUTIONS FOR USE OF AUTOMOTIVE RELAYS”