



2a2b/3a1b/4a 4A polarized power relays

S RELAYS



RoHS compliant

Protective construction: Sealed type

FEATURES

1. Compact with high sensitivity

The high-efficiency polarized electromagnetic circuits of the 4-gap balanced armature and our exclusive spring alignment method achieves, with high-sensitivity in a small package, a relay that can be directly controlled by a driver chip.

2. Strong resistance to vibration and shock

Use of 4G-BA technology realizes strong resistance to vibration and shock.

3. High reliability and long life

Our application of 4G-BA technology, along with almost perfectly complete twin contact, ensures minimal contact bounce and high reliability.

4. Ability to provide wide-ranging control

Use of 4G-BA technology with gold-clad silver alloy contacts in a twin contact structure enables control across a broad range from microcurrents of 100 μ A 100 mV DC to 4 A 250 V AC.

5. Latching types available

With 4G-BA technology, as well as single side stable types, convenient 2 coil latching types for circuit memory applications are also available.

6. Wide variety of contact formations available

The compact size of the 4G-BA mechanism enables the provision of many kinds of package, including 2a2b, 3a1b, and 4a. These meet your needs across a broad range of applications.

7. Low thermal electromotive force

High sensitivity (low power consumption) is realized by 4G-BA technology. Separation of the coil and spring sections has resulted in a relay with extremely low levels of thermal electromotive force (approx. 3 μ V).

8. DIL terminal array

Deployed to fit a 2.54 mm .100 inch grid, the terminals are presented in DIL arrays which match the printed circuit board terminal patterns commonly in international use.

9. Relays that push the boundaries of relay efficiency

High-density S relays take you close to the limits of relay efficiency.

10. Sockets are available.

TYPICAL APPLICATIONS

Telecommunications equipment, data processing equipment, facsimiles, alarm equipment, measuring equipment.

4-GAP BALANCED ARMATURE MECHANISM

1. Armature mechanism has excellent resistance to vibration and shock

The armature structure enables free rotation around the armature center of gravity. Because the mass is maintained in balance at the fulcrum of the axis of rotation, large rotational forces do not occur even if acceleration is applied along any vector. The mechanism has proven to have excellent resistance to vibration and shock. All our S relays are based on this balanced armature mechanism, which is able to further provide many other characteristics.

2. High sensitivity and reliability provided by 4-gap balanced armature mechanism

As a (polarized) balanced armature, the S relay armature itself has two permanent magnets. Presenting four interfaces, the armature has a 4-gap structure. As a result, the rotational axis at either end of the armature is symmetrical and, in an energized into a polarized state, the twin magnetic armature interfaces are subject to repulsion on one side and attraction on the other. This mechanism, exclusive to

Panasonic Corporation, provides a highly efficient polarized magnetic circuit structure that is both highly sensitive and has a small form factor. Moreover, suitability for provision with many types of contact array and other advantages promise to make it possible to provide many of the various characteristics that are coming to be demanded of relays.

HOW IT WORKS (single side stable type)

- 1) When current is passed through the coil, the yoke becomes magnetic and polarized.
- 2) At either pole of the armature, repulsion on one side and attraction on the other side is caused by the interaction of the poles and the permanent magnets of the armature.
- 3) At this time, opening and closing operates owing to the action of the simultaneously moulded balanced armature mechanism, so that when the force of the contact breaker spring closes the contact on one side, on the other side, the balanced armature opens the contact (2a2b).

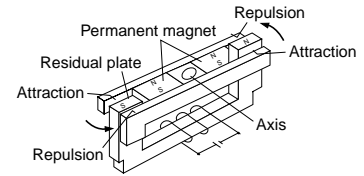

ORDERING INFORMATION

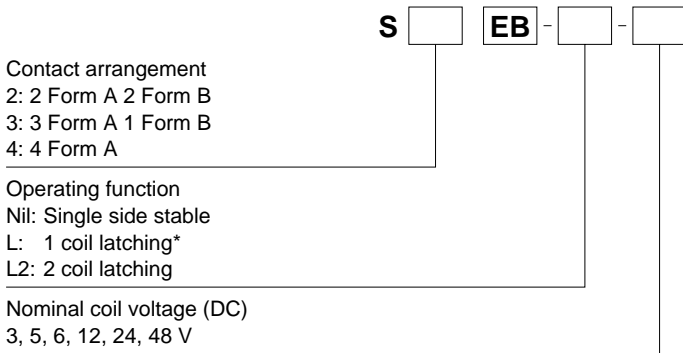

Notes: 1. *1 coil latching type are manufactured by lot upon receipt of order.
 2. Certified by UL and CSA

TYPES

| Contact arrangement | Nominal coil voltage | Single side stable | | 2 coil latching | |
|---------------------|----------------------|--------------------|-------------|-----------------|-------------|
| | | Part No. | Part No. | Part No. | Part No. |
| 2 Form A 2 Form B | 3V DC | S2EB-3V | S2EB-L2-3V | S2EB-L2-3V | S2EB-L2-3V |
| | 5V DC | S2EB-5V | S2EB-L2-5V | S2EB-L2-5V | S2EB-L2-5V |
| | 6V DC | S2EB-6V | S2EB-L2-6V | S2EB-L2-6V | S2EB-L2-6V |
| | 12V DC | S2EB-12V | S2EB-L2-12V | S2EB-L2-12V | S2EB-L2-12V |
| | 24V DC | S2EB-24V | S2EB-L2-24V | S2EB-L2-24V | S2EB-L2-24V |
| 3 Form A 1 Form B | 48V DC | S2EB-48V | S2EB-L2-48V | S2EB-L2-48V | S2EB-L2-48V |
| | 3V DC | S3EB-3V | S3EB-L2-3V | S3EB-L2-3V | S3EB-L2-3V |
| | 5V DC | S3EB-5V | S3EB-L2-5V | S3EB-L2-5V | S3EB-L2-5V |
| | 6V DC | S3EB-6V | S3EB-L2-6V | S3EB-L2-6V | S3EB-L2-6V |
| | 12V DC | S3EB-12V | S3EB-L2-12V | S3EB-L2-12V | S3EB-L2-12V |
| 4 Form A | 24V DC | S3EB-24V | S3EB-L2-24V | S3EB-L2-24V | S3EB-L2-24V |
| | 48V DC | S3EB-48V | S3EB-L2-48V | S3EB-L2-48V | S3EB-L2-48V |
| | 3V DC | S4EB-3V | S4EB-L2-3V | S4EB-L2-3V | S4EB-L2-3V |
| | 5V DC | S4EB-5V | S4EB-L2-5V | S4EB-L2-5V | S4EB-L2-5V |
| | 6V DC | S4EB-6V | S4EB-L2-6V | S4EB-L2-6V | S4EB-L2-6V |
| | 12V DC | S4EB-12V | S4EB-L2-12V | S4EB-L2-12V | S4EB-L2-12V |
| | 24V DC | S4EB-24V | S4EB-L2-24V | S4EB-L2-24V | S4EB-L2-24V |
| | 48V DC | S4EB-48V | S4EB-L2-48V | S4EB-L2-48V | S4EB-L2-48V |

Standard packing: Carton: 50 pcs.; Case: 500 pcs.

* Sockets available.

RATING

1. Coil data

1) Single side stable

| Type | Nominal coil voltage | Pick-up voltage (at 20°C 68°F) | Drop-out voltage (at 20°C 68°F) | Nominal operating current [±10%] (at 20°C 68°F) | Coil resistance [±10%] (at 20°C 68°F) | Nominal operating power | Coil inductance | Max. applied voltage (at 40°C 104°F) |
|----------|----------------------|---|---|---|---------------------------------------|-------------------------|-----------------|--------------------------------------|
| Standard | 3V DC | 70%V or less of nominal voltage (Initial) | 10%V or more of nominal voltage (Initial) | 66.7mA | 45Ω | 200mW | Approx. 23mH | 5.5V DC |
| | 5V DC | | | 38.5mA | 130Ω | 192mW | Approx. 65mH | 9.0V DC |
| | 6V DC | | | 33.3mA | 180Ω | 200mW | Approx. 93mH | 11.0V DC |
| | 12V DC | | | 16.7mA | 720Ω | 200mW | Approx. 370mH | 22.0V DC |
| | 24V DC | | | 8.4mA | 2,850Ω | 202mW | Approx. 1,427mH | 44.0V DC |
| | 48V DC | | | 5.6mA | 8,500Ω | 271mW | Approx. 3,410mH | 75.0V DC |

2) 2 coil latching

| Type | Nominal coil voltage | Set voltage (at 20°C 68°F) | Reset voltage (at 20°C 68°F) | Nominal operating current [$\pm 10\%$] (at 20°C 68°F) | | Coil resistance [$\pm 10\%$] (at 20°C 68°F) | | Nominal operating power (at 20°C 68°F) | | Coil inductance | | Max. applied voltage (at 40°C 104°F) |
|----------|----------------------|---|---|---|------------|---|----------------|--|------------|-----------------|-----------------|--------------------------------------|
| | | | | Set coil | Reset coil | Set coil | Reset coil | Set coil | Reset coil | Set coil | Reset coil | |
| Standard | 3V DC | 70%V or less of nominal voltage (Initial) | 70%V or less of nominal voltage (Initial) | 66.7mA | 66.7mA | 45 Ω | 45 Ω | 200mW | 200mW | Approx. 10mH | Approx. 10mH | 5.5V DC |
| | 5V DC | | | 38.5mA | 38.5mA | 130 Ω | 130 Ω | 192mW | 192mW | Approx. 31mH | Approx. 31mH | 9.0V DC |
| | 6V DC | | | 33.7mA | 33.7mA | 180 Ω | 180 Ω | 200mW | 200mW | Approx. 40mH | Approx. 40mH | 11.0V DC |
| | 12V DC | | | 16.7mA | 16.7mA | 720 Ω | 720 Ω | 200mW | 200mW | Approx. 170mH | Approx. 170mH | 22.0V DC |
| | 24V DC | | | 8.4mA | 8.4mA | 2,850 Ω | 2,850 Ω | 202mW | 202mW | Approx. 680mH | Approx. 680mH | 44.0V DC |
| | 48V DC | | | 7.4mA | 7.4mA | 6,500 Ω | 6,500 Ω | 355mW | 355mW | Approx. 1,250mH | Approx. 1,250mH | 65.0V DC |

2. Specifications

| Characteristics | Item | Specifications | |
|--|---|---|--|
| Contact | Arrangement | 2 Form A 2 Form B, 3 Form A 1 Form B, 4 Form A | |
| | Contact resistance (Initial) | Max. 50 m Ω (By voltage drop 6 V DC 1A) | |
| | Electrostatic capacitance (initial) | Approx. 3pF | |
| | Contact material | Au clad Ag alloy (Cd free) | |
| | Thermal electromotive force (at nominal coil voltage) (initial) | Approx. 3 μ V | |
| Rating | Nominal switching capacity (resistive load) | 4 A 250 V AC, 3 A 30 V DC | |
| | Max. switching power (resistive load) | 1,000 VA, 90 W | |
| | Max. switching voltage | 250 V AC, 48 V DC (30 to 48 V DC at less than 0.5 A) | |
| | Max. switching current | 4 A (AC), 3 A (DC) | |
| | Minimum operating power | 100 mW (Single side stable, 2 coil latching) (Except 48V DC type) | |
| | Nominal operating power | 200 mW (Single side stable, 2 coil latching) (Except 48V DC type) | |
| | Min. switching capacity (Reference value)*1 | 100 μ A 100 m V DC | |
| Electrical characteristics | Insulation resistance (Initial) | Min. 10,000M Ω (at 500V DC) Measurement at same location as "Breakdown voltage" section. | |
| | Breakdown voltage (Initial) | Between open contacts | 750 Vrms for 1min. (Detection current: 10mA.) |
| | | Between contact sets | 1,000 Vrms for 1min. (Detection current: 10mA.) |
| | | Between contact and coil | 1,500 Vrms for 1min. (Detection current: 10mA.) |
| | Temperature rise (coil) (at 20°C 68°F) | Max. 35°C (By resistive method, nominal coil voltage applied to the coil; contact carrying current: 4A.) | |
| | Operate time [Set time] (at 20°C 68°F) | Max. 15 ms [15 ms] (Nominal coil voltage applied to the coil, excluding contact bounce time.) | |
| Release time [Reset time] (at 20°C 68°F) | Max. 10 ms [15 ms] (Nominal coil voltage applied to the coil, excluding contact bounce time.) (without diode) | | |
| Mechanical characteristics | Shock resistance | Functional | Min. 490 m/s ² (Half-wave pulse of sine wave: 11 ms; detection time: 10 μ s.) |
| | | Destructive | Min. 980 m/s ² (Half-wave pulse of sine wave: 6 ms.) |
| | Vibration resistance | Functional | 10 to 55 Hz at double amplitude of 3 mm (Detection time: 10 μ s.) |
| | | Destructive | 10 to 55 Hz at double amplitude of 4 mm |
| Expected life | Mechanical | Min. 10 ⁸ (at 50 cps) | |
| | Electrical | Min. 10 ⁵ (4 A 250 V AC), Min. 2 \times 10 ⁵ (3 A 30 V DC) (at 20 times/min.) | |
| Conditions | Conditions for operation, transport and storage*2 | Ambient temperature: -55°C to +65°C -67°F to +149°F Humidity: 5 to 85% R.H. (Not freezing and condensing at low temperature) | |
| | Max. operating speed | 20 times/min. for maximum load, 50 cps for low-level load (1 mA 1 V DC) | |
| Unit weight | | Approx. 8 g .28 oz | |

Notes: *1. This value can change due to the switching frequency, environmental conditions, and desired reliability level, therefore it is recommended to check this with the actual load.

*2. The upper limit of the ambient temperature is the maximum temperature that can satisfy the coil temperature rise value. Refer to Usage, transport and storage conditions in NOTES.

REFERENCE DATA

1. Maximum switching power

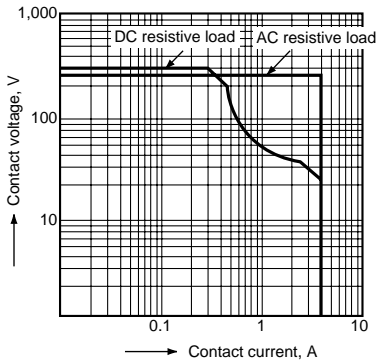

2. Life curve

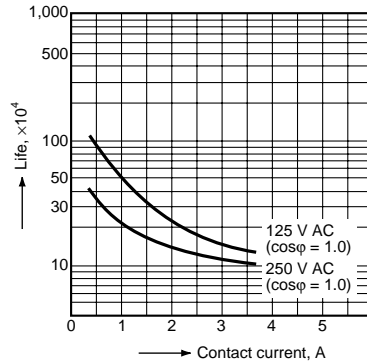

3. Contact reliability

Condition: 1V DC, 1mA
 Detection level 10 Ω
 Tasted Sample: S4EB-24V, 10pcs

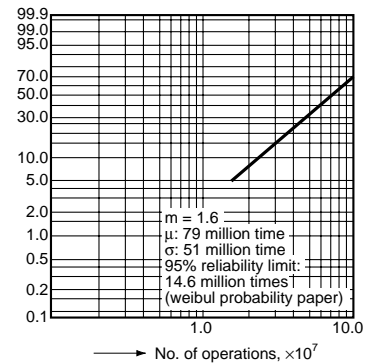

4.-(1) Coil temperature rise

Tested Sample: S4EB-24V, 4 Form A

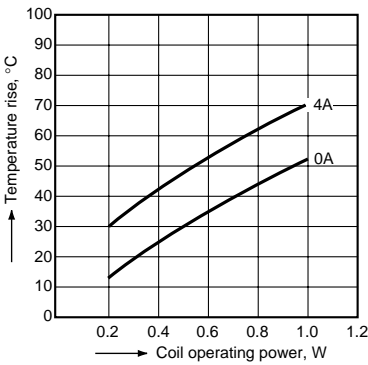

4.-(2) Coil temperature rise

Tested Sample: S4EB-24V, 4 Form A

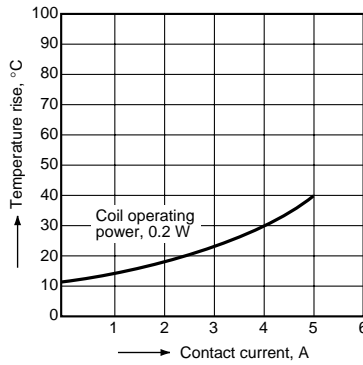

5. Operate and release time

(Single side stable type)

Tested Sample: S4EB-24V, 10pcs

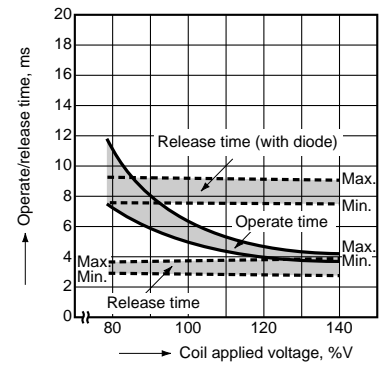

6. Influence of adjacent mounting

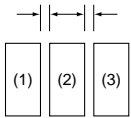

(1) & (3) relays are energized

Note: When installing an S-relay near another, and there is no effect from an external magnetic field, be sure to leave at least 10 mm .394 inch between relays in order to achieve the performance listed in the catalog.

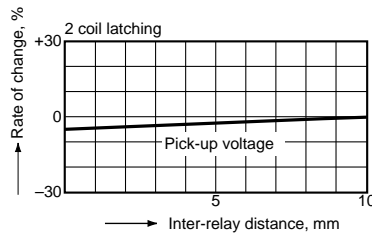
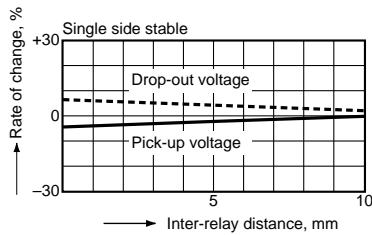

7. Thermal electromotive force

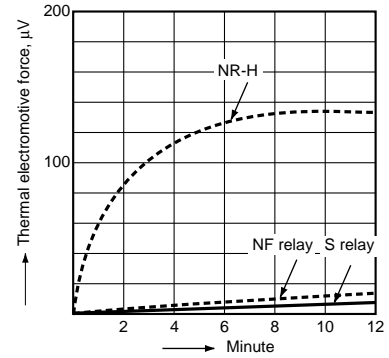

8. Effect from an external magnetic field

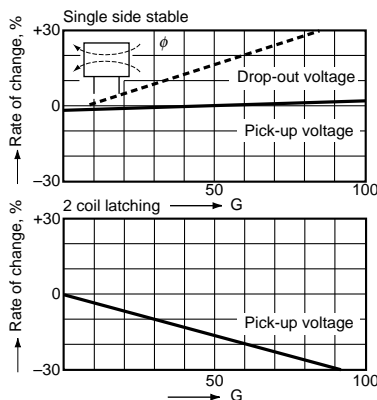
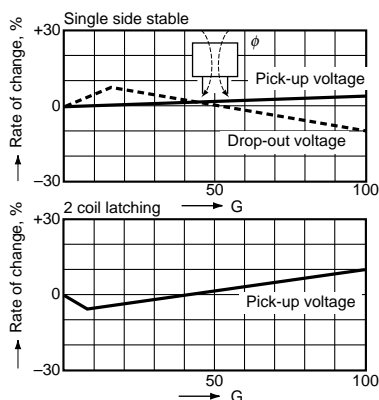



ACCESSORIES

S RELAYS PC BOARD SOCKET



RoHS compliant

DIMENSIONS (mm inch)

The CAD data of the products with a **CAD Data** mark can be downloaded from: <http://industrial.panasonic.com/ac/e/>

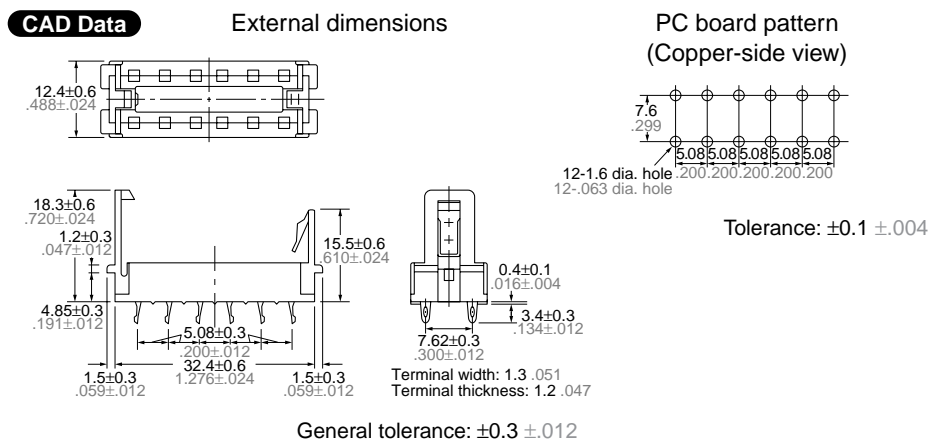

TYPES

| Product name | Part No. |
|--------------------------|----------|
| S Relays PC board socket | S-PS |

SPECIFICATIONS

| | |
|----------------------------|--|
| Maximum continuous current | 4 A Note: Don't insert or remove relays while in the energized condition. |
| Breakdown voltage | 1,500 Vrms between terminals |
| Insulation resistance | More than 100 MΩ between terminals at 500 V DC Mega |
| Heat resistance | 150 $\pm 3^{\circ}\text{C}$ (302 $\pm 5.4^{\circ}\text{F}$) for 1 hour. |

NOTES

Inserting and removing method

Inserting method: Insert the relay as shown in Fig. 1 unit the rib of the relay snaps into the clip of the socket.

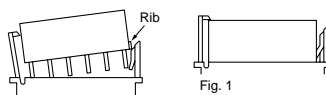

Removing method:

(1) Remove the relay straight from the socket holding the shaded portion of the relay as shown in Fig. 2.

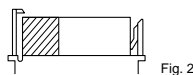

(2) When sockets are mounted in close proximity, use a slotted screw driver as shown in Fig. 3.

