

**LOW-PROFILE  
SURFACE-MOUNT RELAY**

**TQ SMD RELAYS**

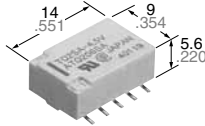

mm inch

**FEATURES**

- **Low-profile:** 6 mm .236 inch  
(Tape height: max. 6.5 mm .256 inch)
- **Tape and reel package is available as standard packing style**
- **Surge withstand between contacts and coil:** 2,500 V
- **Breakdown voltage between contacts and coil:** 1,500 V
- **Capacity:** 2 A
- **High sensitivity:**  
2 Form C; 140 mW power consumption (Single side stable type)

**RoHS Directive compatibility information**  
<http://www.nais-e.com/>

**SPECIFICATIONS**

Contact			
Arrangement		2 Form C	
Initial contact resistance, max. (By voltage drop 6 V DC 1 A)		75 mΩ	
Contact material		Au-clad AgNi type	
Rating	Nominal switching capacity (resistive load)	2 A 30 V DC, 0.5 A 125 V AC	
	Max. switching power (resistive load)	60 W, 62.5 VA	
	Max. switching voltage	220 V DC, 125 V AC	
	Max. switching current	2 A	
	Min. switching capacity (Reference value) <sup>#1</sup>	10 μA 10 mV DC	
Nominal operating power	Single side stable	140 mW (1.5 to 12 V DC) 200 mW (24 V DC) 300 mW (48 V DC)	
	1 coil latching	70 mW (1.5 to 12 V DC) 100 mW (24 V DC)	
	2 coil latching	140 mW (1.5 to 12 V DC) 200 mW (24 V DC)	
Expected life (min. operations)	Mechanical (at 180 cpm)	10 <sup>8</sup>	
	Electrical (at 20 cpm)	2 A 30 V DC resistive	10 <sup>5</sup>
		1 A 30 V DC resistive	2×10 <sup>5</sup>
	0.5 A 125 V AC resistive	10 <sup>5</sup>	

**Note:**  
#1 This value can change due to the switching frequency, environmental conditions, and desired reliability level, therefore it is recommended to check this with the actual load. (SX relays are available for low level load switching [10V DC, 10mA max. level])

**Remarks**

- \* Specifications will vary with foreign standards certification ratings.
- <sup>#1</sup> Measurement at same location as "Initial breakdown voltage" section.
- <sup>#2</sup> By resistive method, nominal voltage applied to the coil; contact carrying current: 2 A.
- <sup>#3</sup> Nominal voltage applied to the coil, excluding contact bounce time.
- <sup>#4</sup> Nominal voltage applied to the coil, excluding contact bounce time without diode.
- <sup>#5</sup> Half-wave pulse of sine wave: 6 ms; detection time: 10 μs
- <sup>#6</sup> Half-wave pulse of sine wave: 6 ms
- <sup>#7</sup> Detection time: 10 μs
- <sup>#8</sup> Refer to 6. Conditions for operation, transport and storage mentioned in AMBIENT ENVIRONMENT .

**Characteristics**

Initial insulation resistance <sup>*1</sup>		Min. 1,000 MΩ (at 500 V DC)
Initial breakdown voltage	Between open contacts	1,000 Vrms for 1 min. (Detection current: 10 mA)
	Between contact sets	1,500 Vrms for 1 min. (Detection current: 10 mA)
	Between contact and coil	1,500 Vrms for 1 min. (Detection current: 10 mA)
Initial surge voltage	Between open contacts (10×160 μs)	1,500 V (FCC Part 68)
	Between contacts and coil (2×10 μs)	2,500 V (Telcordia)
Temperature rise <sup>*2</sup> (at 20°C)		Max. 50°C
Operate time [Set time] <sup>*3</sup> (at 20°C)		Max. 4 ms [Max. 4 ms]
Release time [Reset time] <sup>*4</sup> (at 20°C)		Max. 4 ms [Max. 4 ms]
Shock resistance	Functional <sup>*5</sup>	Min. 750 m/s <sup>2</sup> {75 G}
	Destructive <sup>*6</sup>	Min. 1,000 m/s <sup>2</sup> {100 G}
Vibration resistance	Functional <sup>*7</sup>	200 m/s <sup>2</sup> {20G}, 10 to 55 Hz at double amplitude of 3.3 mm
	Destructive	294 m/s <sup>2</sup> {30G}, 10 to 55 Hz at double amplitude of 5 mm
Conditions for operation, transport and storage <sup>*8</sup> (Not freezing and condensing at low temperature)	Ambient temperature	-40°C to +85°C <sup>*3</sup> -40°F to +185°F
	Humidity	5 to 85% R.H.
Unit weight		Approx. 2 g .071 oz

## ORDERING INFORMATION

Ex. TQ 2 SA - L - 3V - Z

Contact arrangement	Surface-mount availability	Operating function	Coil voltage (DC)	Packing style
2: 2 Form C	SA: Standard surface-mount terminal type SL: High connection reliability surface-mount terminal type SS: Space saving surface-mount terminal type	Nil: Single side stable L: 1 coil latching L2: 2 coil latching	1.5, 3, 4.5, 5, 6, 9, 12, 24, 48* V	Nil: Tube packing Z: Tape and reel packing (picked from the 6/7/8/9/10-pin side)

\*48 V coil type: Single side stable only

Notes: 1. Tape and reel (picked from 1/2/3/4/5-pin side) is also available by request. Part No. suffix "-X" is needed when ordering. (ex.) TQ2SA-3V-X  
2. Tape and reel packing symbol "-Z" or "-X" are not marked on the relay.

## TYPES

## 1. Single side stable

Part No.	Nominal voltage, V DC	Pick-up voltage, V DC (max.)	Drop-out voltage, V DC (min.)	Nominal operating current, mA ( $\pm 10\%$ )	Coil resistance, $\Omega$ ( $\pm 10\%$ )	Nominal operating power, mW	Max. allowable voltage, V DC
TQ2SO-1.5 V	1.5	1.13	0.15	93.8	16	140	2.2
TQ2SO-3 V	3	2.25	0.3	46.7	64.3	140	4.5
TQ2SO-4.5 V	4.5	3.38	0.45	31	145	140	6.7
TQ2SO-5 V	5	3.75	0.5	28.1	178	140	7.5
TQ2SO-6 V	6	4.5	0.6	23.3	257	140	9
TQ2SO-9 V	9	6.75	0.9	15.5	579	140	13.5
TQ2SO-12 V	12	9	1.2	11.7	1,028	140	18
TQ2SO-24 V	24	18	2.4	8.3	2,880	200	36
TQ2SO-48 V	48	36	4.8	6.3	7,680	300	57.6

## 2. 1 coil latching

Part No.	Nominal voltage, V DC	Set voltage, V DC (max.)	Reset voltage, V DC (max.)	Nominal operating current, mA ( $\pm 10\%$ )	Coil resistance, $\Omega$ ( $\pm 10\%$ )	Nominal operating power, mW	Max. allowable voltage, V DC
TQ2SO-L-1.5 V	1.5	1.13	1.13	46.9	32	70	2.2
TQ2SO-L-3 V	3	2.25	2.25	23.3	128.6	70	4.5
TQ2SO-L-4.5 V	4.5	3.38	3.38	15.6	289.3	70	6.7
TQ2SO-L-5 V	5	3.75	3.75	14	357	70	7.5
TQ2SO-L-6 V	6	4.5	4.5	11.7	514	70	9
TQ2SO-L-9 V	9	6.75	6.75	7.8	1,157	70	13.5
TQ2SO-L-12 V	12	9	9	5.8	2,057	70	18
TQ2SO-L-24 V	24	18	18	4.2	5,760	100	36

## 3. 2 coil latching

Part No.	Nominal voltage, V DC	Set voltage, V DC (max.)	Reset voltage, V DC (max.)	Nominal operating current, mA ( $\pm 10\%$ )	Coil resistance, $\Omega$ ( $\pm 10\%$ )	Nominal operating power, mW	Max. allowable voltage, V DC
TQ2SO-L2-1.5 V	1.5	1.13	1.13	93.8	16	140	2.2
TQ2SO-L2-3 V	3	2.25	2.25	46.7	64.3	140	4.5
TQ2SO-L2-4.5 V	4.5	3.38	3.38	31	145	140	6.7
TQ2SO-L2-5 V	5	3.75	3.75	28.1	178	140	7.5
TQ2SO-L2-6 V	6	4.5	4.5	23.3	257	140	9
TQ2SO-L2-9 V	9	6.75	6.75	15.5	579	140	13.5
TQ2SO-L2-12 V	12	9	9	11.7	1,028	140	18
TQ2SO-L2-24 V	24	18	18	8.3	2,880	200	36

○: For each surface-mounted terminal variation, input the following letter.

SA type: A, SL type: L, SS type: S

Notes: 1. Specified value of the pick-up, drop-out, set and reset voltage is with the condition of square wave coil pulse.

2. Standard packing: Tube: 50 pcs.; Case: 1,000 pcs.

Tape and reel: 500 pcs.; Case: 1,000 pcs.

3. In case of 5 V transistor drive circuit, it is recommended to use 4.5 V type relay.

# TQ SMD

## DIMENSIONS

mm inch

### SA type

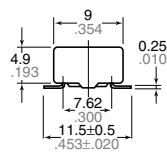
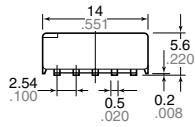

### Recommendable mounting pad (Top view) SA type

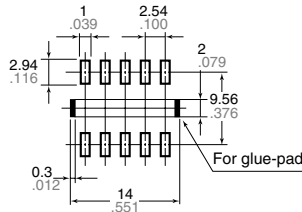

### SL type

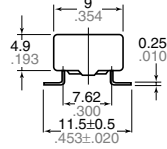
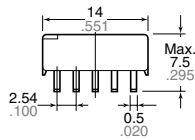

### SL type

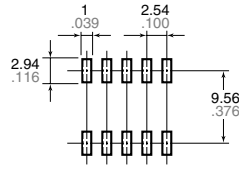

### SS type

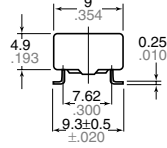
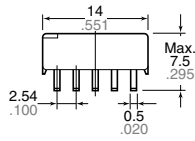

### SS type

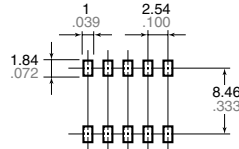

General tolerance:  $\pm 0.3 \pm 0.012$

Tolerance:  $\pm 0.1 \pm 0.004$

### Schematic (Top view)

- Single side stable (Deenergized condition)

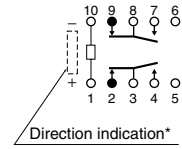

\*Orientation stripe located on top of relay.

- 1-coil latching (Reset condition)

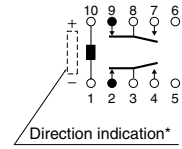

\*Orientation stripe located on top of relay.

- 2-coil latching (Reset condition)

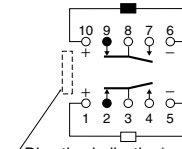

\*Orientation stripe located on top of relay.

## REFERENCE DATA

### 1. Maximum switching capacity

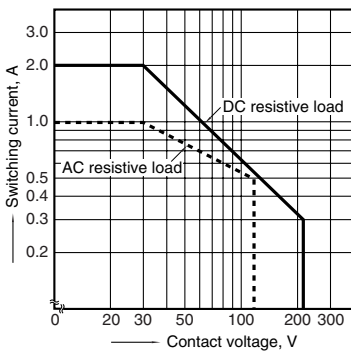

### 2. Life curve

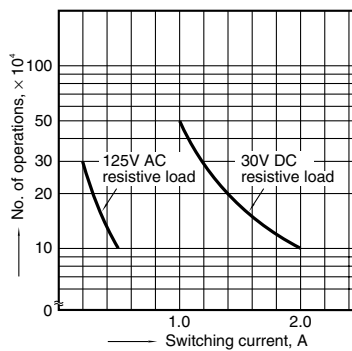

### 3. Mechanical life (mounting by IRS method)

Tested sample: TQ2SA-12V, 10 pcs.

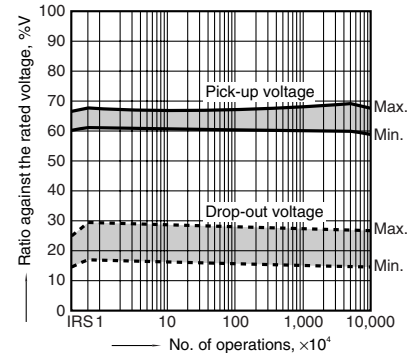

### 4.-(1) Electrical life (2 A 30 V DC resistive load)

Tested sample: TQ2SA-12V, 6 pcs.

Operating frequency: 20 cpm

Change of pick-up and drop-out voltage (mounting by IRS method)

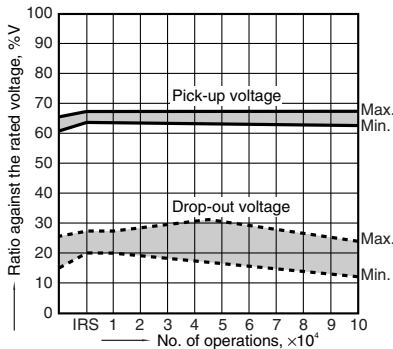

Change of contact resistance (mounting by IRS method)

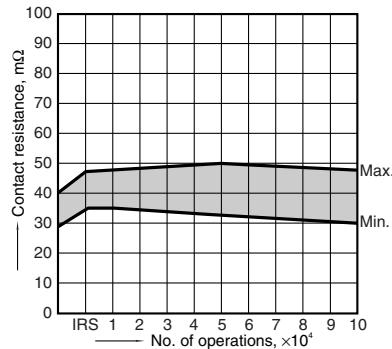

### 4.-(2) Electrical life (0.5 A 125 V AC resistive load)

Tested sample: TQ2SA-12V, 6 pcs

Operating frequency: 20 cpm

Change of pick-up and drop-out voltage (mounting by IRS method)

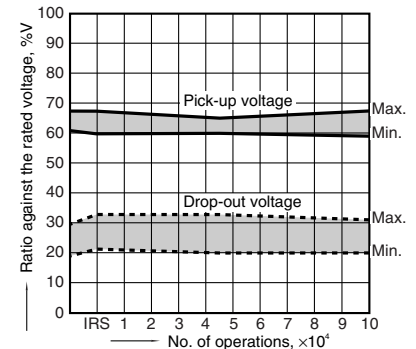

Change of contact resistance (mounting by IRS method)

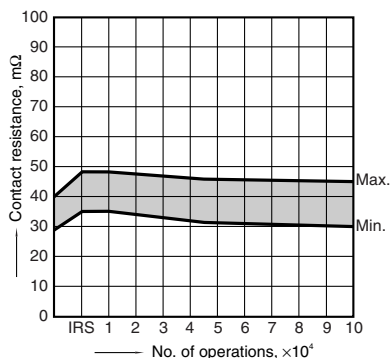

5. Coil temperature rise  
Tested sample: TQ2SA-12V, 6 pcs.  
Point measured: Inside the coil  
Ambient temperature: 25°C 77°F

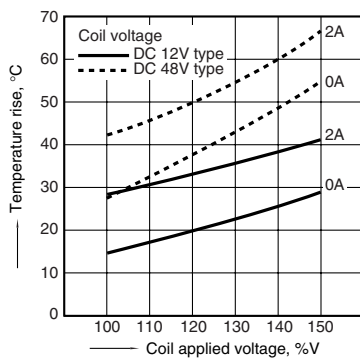

6. Operate/release time  
Tested sample: TQ2SA-12V, 6 pcs.

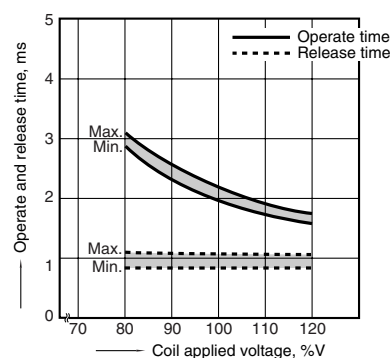

7. Distribution of pick-up and drop out voltage  
Tested sample: TQ2SA-12V, 50 pcs.

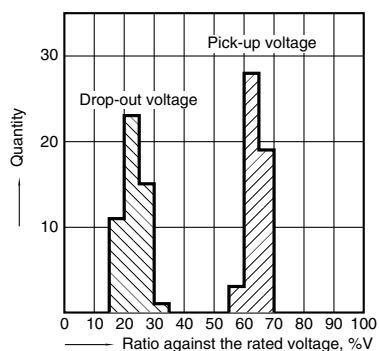

8. Distribution of set and reset voltage  
Tested sample: TQ2SA-L-12V, 30 pcs.

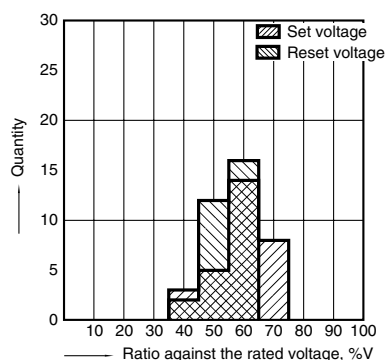

9. Ambient temperature characteristics  
Tested sample: TQ2SA-12V, 5 pcs.

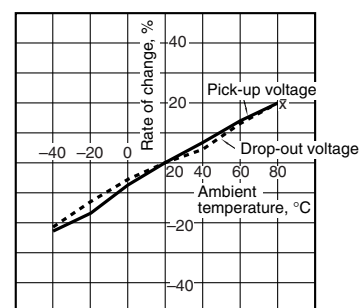

10. Distribution of contact resistance  
Tested sample: TQ2SA-5V, 30 pcs. (30 x 4 contacts)

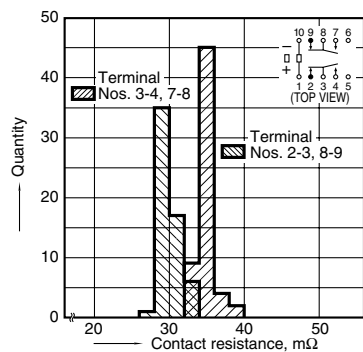

11.-(1) High-frequency characteristics  
Isolation characteristics

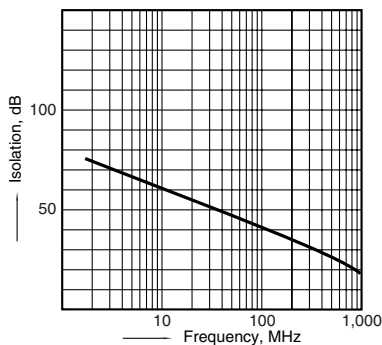

11.-(2) High-frequency characteristics  
Insertion loss characteristics

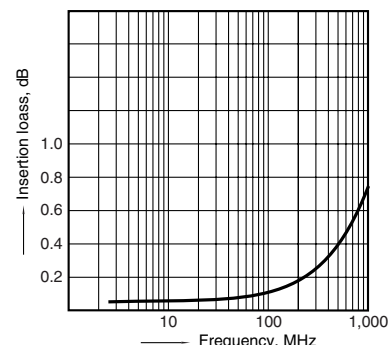

12.-(1) Malfunctional shock (single side stable)  
Tested sample: TQ2SA-12V, 6 pcs

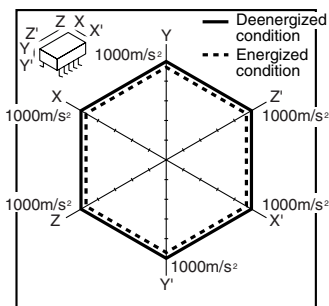

12.-(2) Malfunctional shock (latching)  
Tested sample: TQ2SA-L2-12V, 6 pcs.

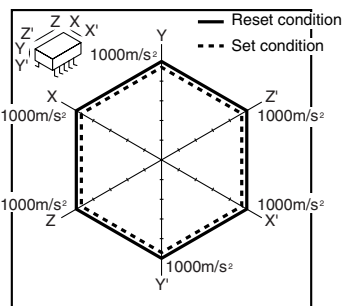

# TQ SMD

13.-(1) Influence of adjacent mounting  
Tested sample: TQ2SA-12V, 5 pcs.

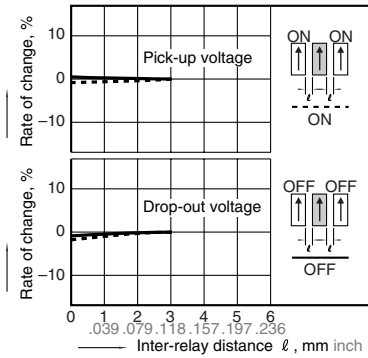

13.-(2) Influence of adjacent mounting  
Tested sample: TQ2SA-12V, 6 pcs.

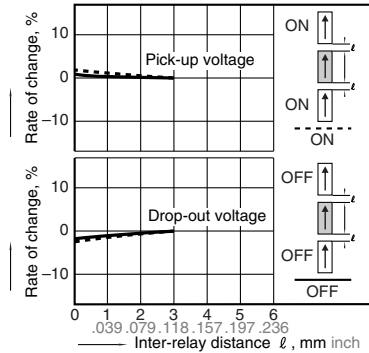

13.-(3) Influence of adjacent mounting  
Tested sample: TQ2SA-12V, 6 pcs.

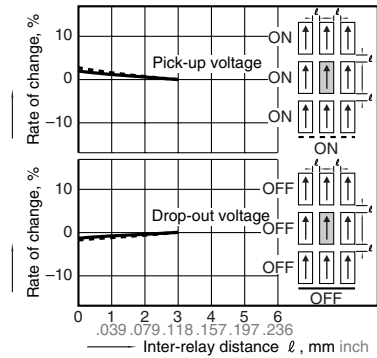

## 14. Pulse dialing test

Tested sample: TQ2SA-12V, 6 pcs.  
(35 mA 48 V DC wire spring relay load)  
Circuit

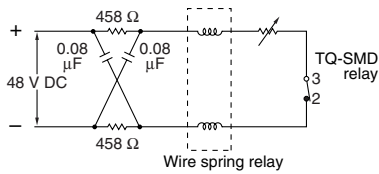

Change of pick-up and drop-out voltage  
(mounting by IRS method)

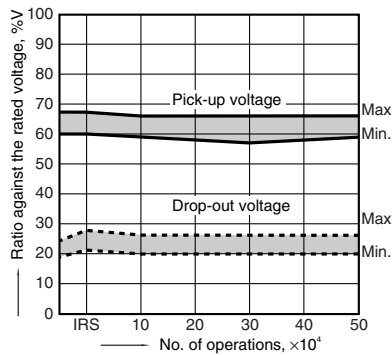

Change of contact resistance  
(mounting by IRS method)

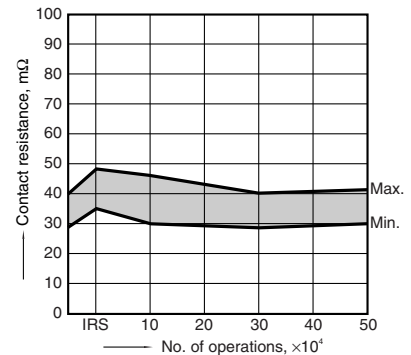

## NOTES

### 1. Packing style

1) The relay is packed in a tube with the relay orientation mark on the left side, as shown in the figure below.

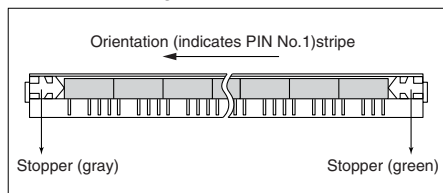

### 2) Tape and reel packing (surface-mount terminal type)

#### (1) Tape dimensions

##### (i) SA type

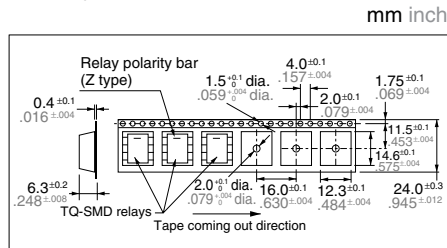

##### (ii) SL, SS type

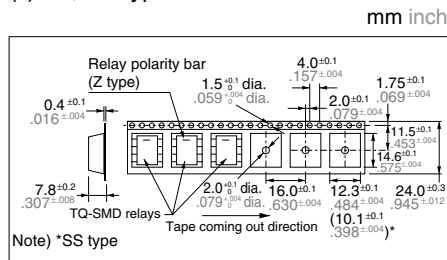

#### (2) Dimensions of plastic reel

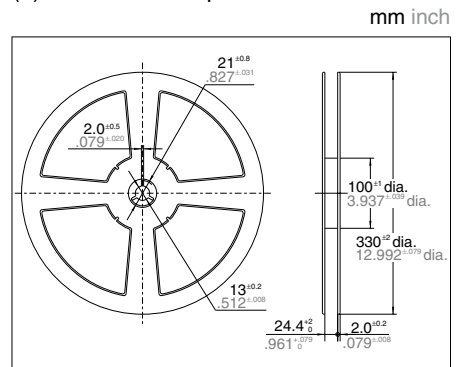

**For Cautions for Use, see Relay Technical Information.**