



### 2a2b/3a1b/4a 4A polarized power relays

## S RELAYS



RoHS compliant

Protective construction: Sealed type

## FEATURES

### 1. Compact with high sensitivity

The high-efficiency polarized electromagnetic circuits of the 4-gap balanced armature and our exclusive spring alignment method achieves, with high-sensitivity in a small package, a relay that can be directly controlled by a driver chip.

### 2. Strong resistance to vibration and shock

Use of 4G-BA technology realizes strong resistance to vibration and shock.

### 3. High reliability and long life

Our application of 4G-BA technology, along with almost perfectly complete twin contact, ensures minimal contact bounce and high reliability.

### 4. Ability to provide wide-ranging control

Use of 4G-BA technology with gold-clad silver alloy contacts in a twin contact structure enables control across a broad range from microcurrents of 100  $\mu$ A 100 mV DC to 4 A 250 V AC.

### 5. Latching types available

With 4G-BA technology, as well as single side stable types, convenient 2 coil latching types for circuit memory applications are also available.

### 6. Wide variety of contact formations available

The compact size of the 4G-BA mechanism enables the provision of many kinds of package, including 2a2b, 3a1b, and 4a. These meet your needs across a broad range of applications.

### 7. Low thermal electromotive force

High sensitivity (low power consumption) is realized by 4G-BA technology. Separation of the coil and spring sections has resulted in a relay with extremely low levels of thermal electromotive force (approx. 3  $\mu$ V).

### 8. DIL terminal array

Deployed to fit a 2.54 mm .100 inch grid, the terminals are presented in DIL arrays which match the printed circuit board terminal patterns commonly in international use.

### 9. Relays that push the boundaries of relay efficiency

High-density S relays take you close to the limits of relay efficiency.

### 10. Sockets are available.

## TYPICAL APPLICATIONS

Telecommunications equipment, data processing equipment, facsimiles, alarm equipment, measuring equipment.

## 4-GAP BALANCED ARMATURE MECHANISM

### 1. Armature mechanism has excellent resistance to vibration and shock

The armature structure enables free rotation around the armature center of gravity. Because the mass is maintained in balance at the fulcrum of the axis of rotation, large rotational forces do not occur even if acceleration is applied along any vector. The mechanism has proven to have excellent resistance to vibration and shock. All our S relays are based on this balanced armature mechanism, which is able to further provide many other characteristics.

### 2. High sensitivity and reliability provided by 4-gap balanced armature mechanism

As a (polarized) balanced armature, the S relay armature itself has two permanent magnets. Presenting four interfaces, the armature has a 4-gap structure. As a result, the rotational axis at either end of the armature is symmetrical and, in an energized into a polarized state, the twin magnetic armature interfaces are subject to repulsion on one side and attraction on the other. This mechanism, exclusive to

Panasonic Corporation, provides a highly efficient polarized magnetic circuit structure that is both highly sensitive and has a small form factor. Moreover, suitability for provision with many types of contact array and other advantages promise to make it possible to provide many of the various characteristics that are coming to be demanded of relays.

## HOW IT WORKS (single side stable type)

- 1) When current is passed through the coil, the yoke becomes magnetic and polarized.
- 2) At either pole of the armature, repulsion on one side and attraction on the other side is caused by the interaction of the poles and the permanent magnets of the armature.
- 3) At this time, opening and closing operates owing to the action of the simultaneously moulded balanced armature mechanism, so that when the force of the contact breaker spring closes the contact on one side, on the other side, the balanced armature opens the contact (2a2b).

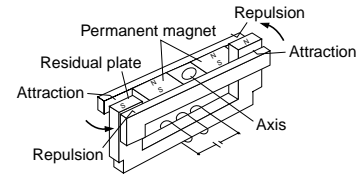

## ORDERING INFORMATION

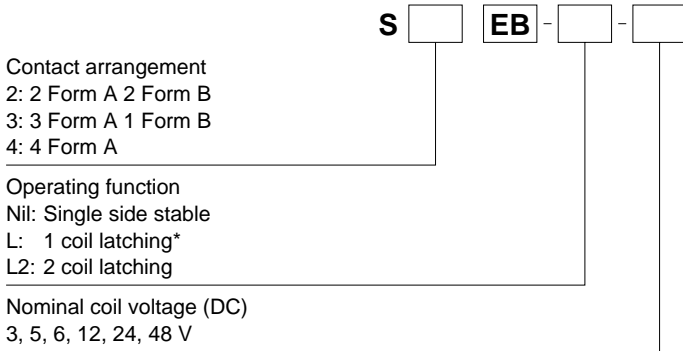

Notes: 1. \*1 coil latching type are manufactured by lot upon receipt of order.  
 2. Certified by UL and CSA

## TYPES

Contact arrangement	Nominal coil voltage	Single side stable		2 coil latching	
		Part No.		Part No.	
2 Form A 2 Form B	3V DC	S2EB-3V		S2EB-L2-3V	
	5V DC	S2EB-5V		S2EB-L2-5V	
	6V DC	S2EB-6V		S2EB-L2-6V	
	12V DC	S2EB-12V		S2EB-L2-12V	
	24V DC	S2EB-24V		S2EB-L2-24V	
	48V DC	S2EB-48V		S2EB-L2-48V	
3 Form A 1 Form B	3V DC	S3EB-3V		S3EB-L2-3V	
	5V DC	S3EB-5V		S3EB-L2-5V	
	6V DC	S3EB-6V		S3EB-L2-6V	
	12V DC	S3EB-12V		S3EB-L2-12V	
	24V DC	S3EB-24V		S3EB-L2-24V	
	48V DC	S3EB-48V		S3EB-L2-48V	
4 Form A	3V DC	S4EB-3V		S4EB-L2-3V	
	5V DC	S4EB-5V		S4EB-L2-5V	
	6V DC	S4EB-6V		S4EB-L2-6V	
	12V DC	S4EB-12V		S4EB-L2-12V	
	24V DC	S4EB-24V		S4EB-L2-24V	
	48V DC	S4EB-48V		S4EB-L2-48V	

Standard packing: Carton: 50 pcs.; Case: 500 pcs.

\* Sockets available.

## RATING

### 1. Coil data

#### 1) Single side stable

Type	Nominal coil voltage	Pick-up voltage (at 20°C 68°F)	Drop-out voltage (at 20°C 68°F)	Nominal operating current [±10%] (at 20°C 68°F)	Coil resistance [±10%] (at 20°C 68°F)	Nominal operating power	Coil inductance	Max. applied voltage (at 40°C 104°F)
Standard	3V DC	70%V or less of nominal voltage (Initial)	10%V or more of nominal voltage (Initial)	66.7mA	45Ω	200mW	Approx. 23mH	5.5V DC
	5V DC			38.5mA	130Ω	192mW	Approx. 65mH	9.0V DC
	6V DC			33.3mA	180Ω	200mW	Approx. 93mH	11.0V DC
	12V DC			16.7mA	720Ω	200mW	Approx. 370mH	22.0V DC
	24V DC			8.4mA	2,850Ω	202mW	Approx. 1,427mH	44.0V DC
	48V DC			5.6mA	8,500Ω	271mW	Approx. 3,410mH	75.0V DC

## 2) 2 coil latching

Type	Nominal coil voltage	Set voltage (at 20°C 68°F)	Reset voltage (at 20°C 68°F)	Nominal operating current [ $\pm 10\%$ ] (at 20°C 68°F)		Coil resistance [ $\pm 10\%$ ] (at 20°C 68°F)		Nominal operating power (at 20°C 68°F)		Coil inductance		Max. applied voltage (at 40°C 104°F)
				Set coil	Reset coil	Set coil	Reset coil	Set coil	Reset coil	Set coil	Reset coil	
Standard	3V DC	70%V or less of nominal voltage (Initial)	70%V or less of nominal voltage (Initial)	66.7mA	66.7mA	45 $\Omega$	45 $\Omega$	200mW	200mW	Approx. 10mH	Approx. 10mH	5.5V DC
	5V DC			38.5mA	38.5mA	130 $\Omega$	130 $\Omega$	192mW	192mW	Approx. 31mH	Approx. 31mH	9.0V DC
	6V DC			33.7mA	33.7mA	180 $\Omega$	180 $\Omega$	200mW	200mW	Approx. 40mH	Approx. 40mH	11.0V DC
	12V DC			16.7mA	16.7mA	720 $\Omega$	720 $\Omega$	200mW	200mW	Approx. 170mH	Approx. 170mH	22.0V DC
	24V DC			8.4mA	8.4mA	2,850 $\Omega$	2,850 $\Omega$	202mW	202mW	Approx. 680mH	Approx. 680mH	44.0V DC
	48V DC			7.4mA	7.4mA	6,500 $\Omega$	6,500 $\Omega$	355mW	355mW	Approx. 1,250mH	Approx. 1,250mH	65.0V DC

## 2. Specifications

Characteristics	Item	Specifications	
Contact	Arrangement	2 Form A 2 Form B, 3 Form A 1 Form B, 4 Form A	
	Contact resistance (Initial)	Max. 50 m $\Omega$ (By voltage drop 6 V DC 1A)	
	Electrostatic capacitance (initial)	Approx. 3pF	
	Contact material	Au clad Ag alloy (Cd free)	
	Thermal electromotive force (at nominal coil voltage) (initial)	Approx. 3 $\mu$ V	
Rating	Nominal switching capacity (resistive load)	4 A 250 V AC, 3 A 30 V DC	
	Max. switching power (resistive load)	1,000 VA, 90 W	
	Max. switching voltage	250 V AC, 48 V DC (30 to 48 V DC at less than 0.5 A)	
	Max. switching current	4 A (AC), 3 A (DC)	
	Minimum operating power	100 mW (Single side stable, 2 coil latching) (Except 48V DC type)	
	Nominal operating power	200 mW (Single side stable, 2 coil latching) (Except 48V DC type)	
	Min. switching capacity (Reference value)*1	100 $\mu$ A 100 m V DC	
Electrical characteristics	Insulation resistance (Initial)	Min. 10,000M $\Omega$ (at 500V DC) Measurement at same location as "Breakdown voltage" section.	
	Breakdown voltage (Initial)	Between open contacts	750 Vrms for 1min. (Detection current: 10mA.)
		Between contact sets	1,000 Vrms for 1min. (Detection current: 10mA.)
		Between contact and coil	1,500 Vrms for 1min. (Detection current: 10mA.)
	Temperature rise (coil) (at 20°C 68°F)	Max. 35°C (By resistive method, nominal coil voltage applied to the coil; contact carrying current: 4A.)	
	Operate time [Set time] (at 20°C 68°F)	Max. 15 ms [15 ms] (Nominal coil voltage applied to the coil, excluding contact bounce time.)	
Release time [Reset time] (at 20°C 68°F)	Max. 10 ms [15 ms] (Nominal coil voltage applied to the coil, excluding contact bounce time.) (without diode)		
Mechanical characteristics	Shock resistance	Functional	Min. 490 m/s <sup>2</sup> (Half-wave pulse of sine wave: 11 ms; detection time: 10 $\mu$ s.)
		Destructive	Min. 980 m/s <sup>2</sup> (Half-wave pulse of sine wave: 6 ms.)
	Vibration resistance	Functional	10 to 55 Hz at double amplitude of 3 mm (Detection time: 10 $\mu$ s.)
		Destructive	10 to 55 Hz at double amplitude of 4 mm
Expected life	Mechanical	Min. 10 <sup>8</sup> (at 50 cps)	
	Electrical	Min. 10 <sup>5</sup> (4 A 250 V AC), Min. 2 $\times$ 10 <sup>5</sup> (3 A 30 V DC) (at 20 times/min.)	
Conditions	Conditions for operation, transport and storage*2	Ambient temperature: -55°C to +65°C -67°F to +149°F Humidity: 5 to 85% R.H. (Not freezing and condensing at low temperature)	
	Max. operating speed	20 times/min. for maximum load, 50 cps for low-level load (1 mA 1 V DC)	
Unit weight		Approx. 8 g .28 oz	

Notes: \*1. This value can change due to the switching frequency, environmental conditions, and desired reliability level, therefore it is recommended to check this with the actual load.

\*2. The upper limit of the ambient temperature is the maximum temperature that can satisfy the coil temperature rise value. Refer to Usage, transport and storage conditions in NOTES.

# REFERENCE DATA

## 1. Maximum switching power

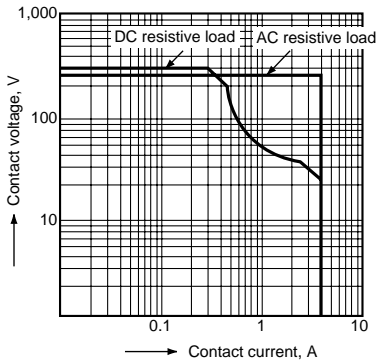

## 2. Life curve

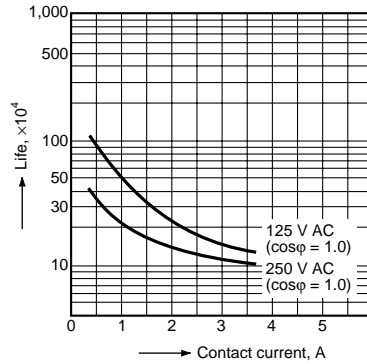

## 3. Contact reliability

Condition: 1V DC, 1mA  
 Detection level 10  $\Omega$   
 Tasted Sample: S4EB-24V, 10pcs

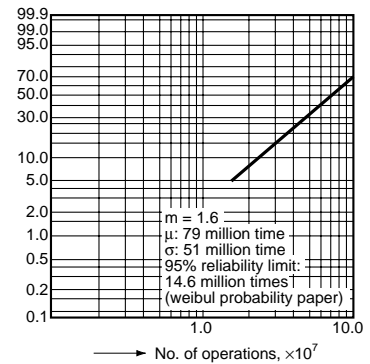

## 4.-(1) Coil temperature rise

Tested Sample: S4EB-24V, 4 Form A

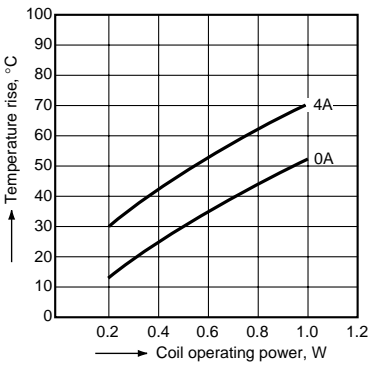

## 4.-(2) Coil temperature rise

Tested Sample: S4EB-24V, 4 Form A

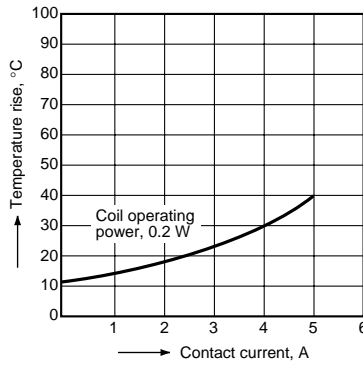

## 5. Operate and release time

(Single side stable type)

Tested Sample: S4EB-24V, 10pcs

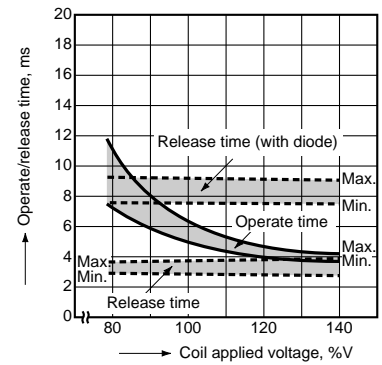

## 6. Influence of adjacent mounting

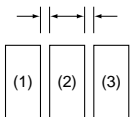

Note: When installing an S-relay near another, and there is no effect from an external magnetic field, be sure to leave at least 10 mm .394 inch between relays in order to achieve the performance listed in the catalog.

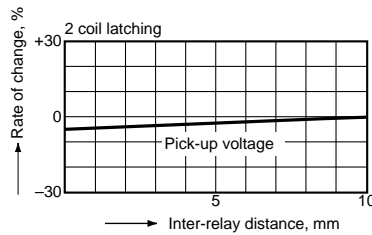
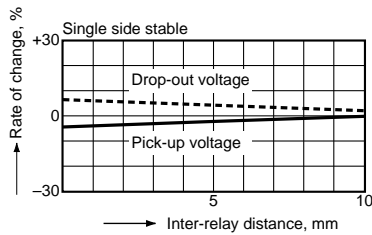

## 7. Thermal electromotive force

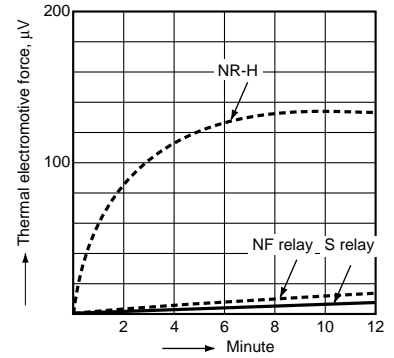

## 8. Effect from an external magnetic field

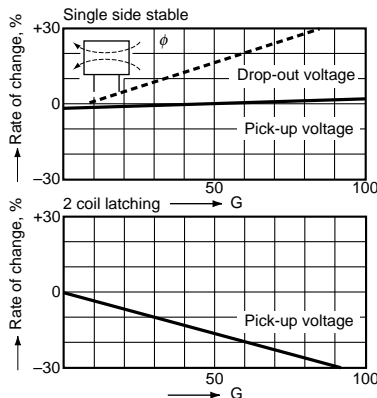
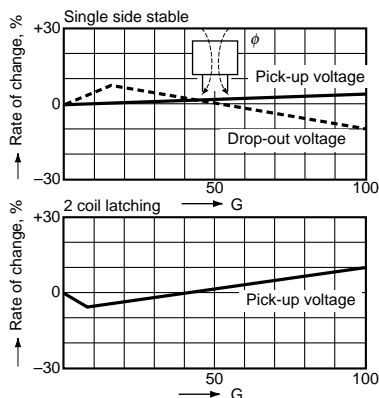

# DIMENSIONS (mm inch)

The CAD data of the products with a **CAD Data** mark can be downloaded from: <http://industrial.panasonic.com/ac/e/>

**CAD Data**



External dimensions

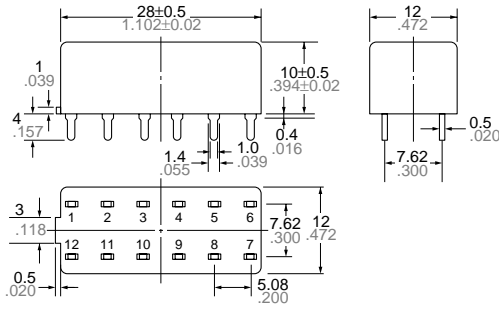

General tolerance: ±0.3 ±.012

PC board pattern (Copper-side view)

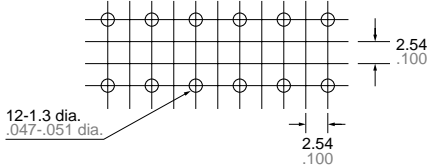

Tolerance: ±0.1 ±.004

Schematic (Bottom view)

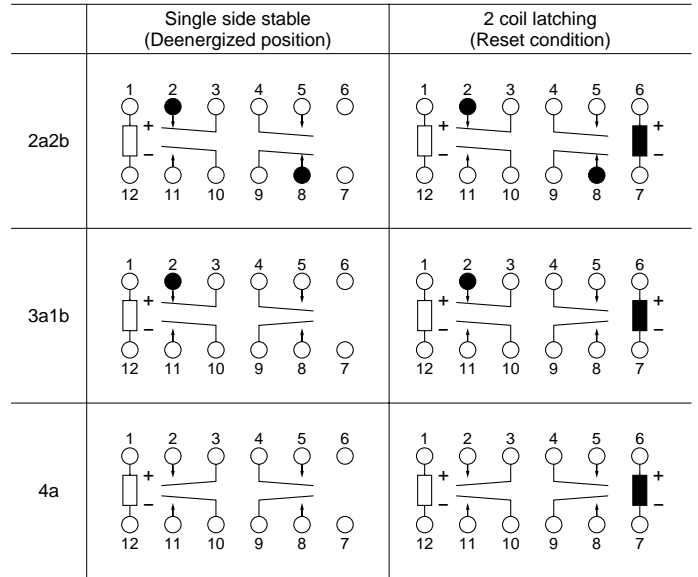

## SAFETY STANDARDS

UL/C-UL (Recognized)		CSA (Certified)	
File No.	Contact rating	File No.	Contact rating
E43028	4A 250V AC, 1/20HP 125V AC (FLA1.5A) 1/20HP 250V AC (FLA0.75A), 3A 30V DC	LR26550 etc.	4A 250V AC, 1/20HP 125V AC, 1/20HP 250V AC 3A 30V DC

## NOTES

1. For cautions for use, please read "GENERAL APPLICATION GUIDELINES" on page B-1.

2. Based on regulations regarding insulation distance, there is a restriction on same-channel load connections between terminals No. 2, 3 and 4, 5, as well as between No. 8, 9 and 10, 11. See the figure below for an example.

3. Please note that when this relay (2 Form A 2 Form B type, 3 Form A 1 Form B type) operates and releases, contacts a and b may go ON at the same time.

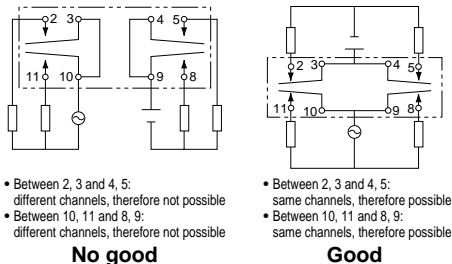

- Between 2, 3 and 4, 5: different channels, therefore not possible
- Between 10, 11 and 8, 9: different channels, therefore not possible

No good

- Between 2, 3 and 4, 5: same channels, therefore possible
- Between 10, 11 and 8, 9: same channels, therefore possible

Good



### ACCESSORIES

# S RELAYS PC BOARD SOCKET



RoHS compliant

### DIMENSIONS (mm inch)

The CAD data of the products with a **CAD Data** mark can be downloaded from: <http://industrial.panasonic.com/ac/e/>

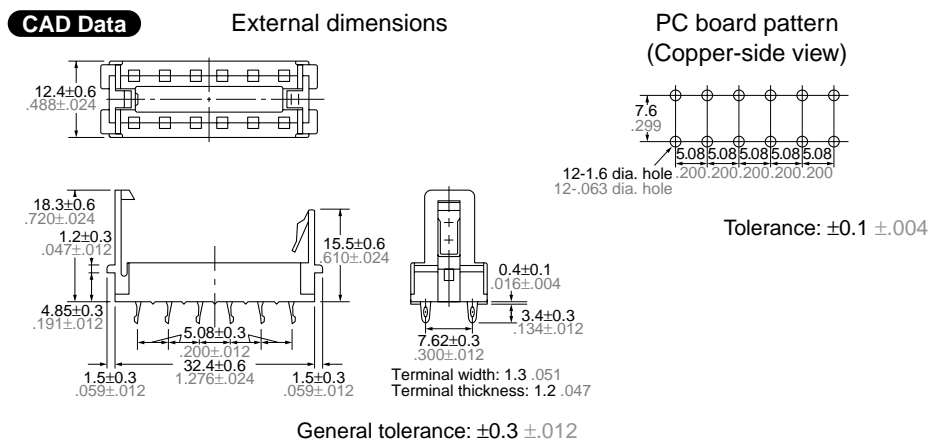

### TYPES

Product name	Part No.
S Relays PC board socket	S-PS

### SPECIFICATIONS

Maximum continuous current	4 A
Breakdown voltage	1,500 Vrms between terminals
Insulation resistance	More than 100 MΩ between terminals at 500 V DC Mega
Heat resistance	150 $\pm 3^{\circ}\text{C}$ (302 $\pm 5.4^{\circ}\text{F}$ ) for 1 hour.

Note: Don't insert or remove relays while in the energized condition.

### NOTES

#### Inserting and removing method

Inserting method: Insert the relay as shown in Fig. 1 unit the rib of the relay snaps into the clip of the socket.

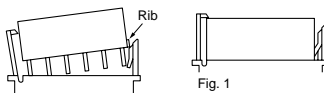

#### Removing method:

(1) Remove the relay straight from the socket holding the shaded portion of the relay as shown in Fig. 2.

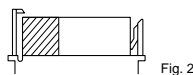

(2) When sockets are mounted in close proximity, use a slotted screw driver as shown in Fig. 3.

