

**High sensitivity, 50 mW  
Nominal operating power,  
2 Form C and 1 A relays**

# TX-S RELAYS

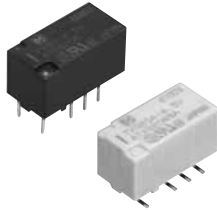

**RoHS compliant**

### FEATURES

- High sensitivity and Nominal operating power of 50mW**
- Compact size**  
15.0 (L) × 7.4 (W) × 8.2 (H) mm  
.591 (L) × .291 (W) × .323 (H) inch
- High contact reliability**  
High contact reliability is achieved by the use of gold-clad twin crossbar contacts, low-gas formation materials, mold sealing the coil section, and by controlling organic gas in the coil.  
**\*We also offer a range of products with AgPd contacts suitable for use in low level load analog circuits (Max. 10V DC 10 mA).**
- Outstanding surge resistance.**  
1,500 V 10×160 μsec. (FCC part 68) (open contacts)  
2,500 V 2×10 μsec. (Telcordia) (contact and coil)
- Low thermal electromotive force (approx. 0.3 μV)**

### TYPICAL APPLICATIONS

- Communications (XDSL, Transmission)
- Measurement
- Security
- Home appliances, and audio/visual equipment
- Medical equipment

### ORDERING INFORMATION

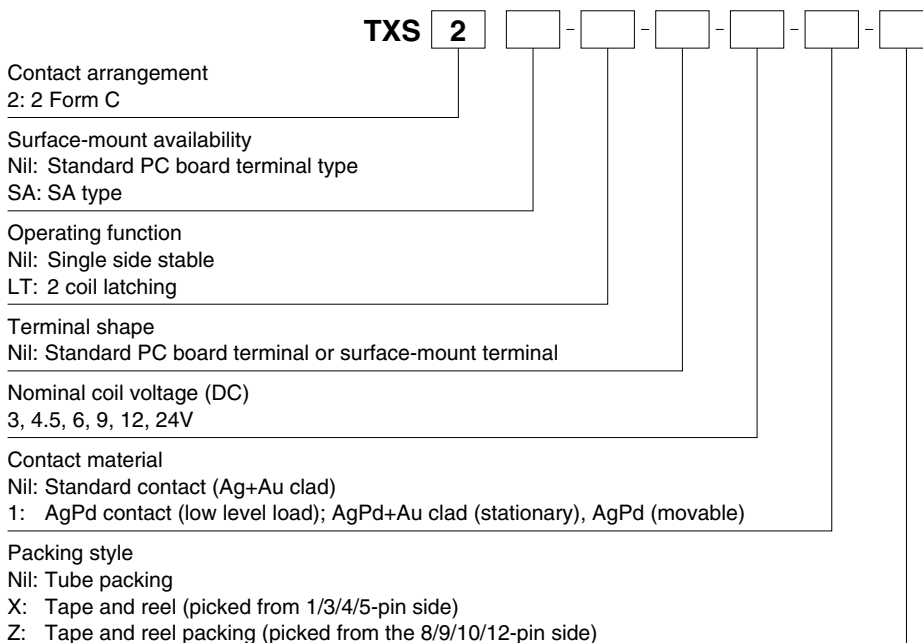

## TYPES

### 1. Standard PC board terminal

| Contact arrangement | Nominal coil voltage | Single side stable |  | 2 coil latching |  |
|---------------------|----------------------|--------------------|--|-----------------|--|
|                     |                      | Part No.           |  | Part No.        |  |
| 2 Form C            | 3 V DC               | TXS2-3V            |  | TXS2-LT-3V      |  |
|                     | 4.5 V DC             | TXS2-4.5V          |  | TXS2-LT-4.5V    |  |
|                     | 6 V DC               | TXS2-6V            |  | TXS2-LT-6V      |  |
|                     | 9 V DC               | TXS2-9V            |  | TXS2-LT-9V      |  |
|                     | 12 V DC              | TXS2-12V           |  | TXS2-LT-12V     |  |
|                     | 24 V DC              | TXS2-24V           |  | TXS2-LT-24V     |  |

Standard packing: Tube: 40 pcs.; Case: 1,000 pcs.

Note: Please add "-1" to the end of the part number for AgPd contacts (low level load).

### 2. Surface-mount terminal

#### 1) Tube packing

| Contact arrangement | Nominal coil voltage | Single side stable |  | 2 coil latching |  |
|---------------------|----------------------|--------------------|--|-----------------|--|
|                     |                      | Part No.           |  | Part No.        |  |
| 2 Form C            | 3 V DC               | TXS2SA-3V          |  | TXS2SA-LT-3V    |  |
|                     | 4.5 V DC             | TXS2SA-4.5V        |  | TXS2SA-LT-4.5V  |  |
|                     | 6 V DC               | TXS2SA-6V          |  | TXS2SA-LT-6V    |  |
|                     | 9 V DC               | TXS2SA-9V          |  | TXS2SA-LT-9V    |  |
|                     | 12 V DC              | TXS2SA-12V         |  | TXS2SA-LT-12V   |  |
|                     | 24 V DC              | TXS2SA-24V         |  | TXS2SA-LT-24V   |  |

Standard packing: Tube: 40 pcs.; Case: 1,000 pcs.

Note: Please add "-1" to the end of the part number for AgPd contacts (low level load).

#### 2) Tape and reel packing

| Contact arrangement | Nominal coil voltage | Single side stable |  | 2 coil latching  |  |
|---------------------|----------------------|--------------------|--|------------------|--|
|                     |                      | Part No.           |  | Part No.         |  |
| 2 Form C            | 3 V DC               | TXS2SA-3V-Z        |  | TXS2SA-LT-3V-Z   |  |
|                     | 4.5 V DC             | TXS2SA-4.5V-Z      |  | TXS2SA-LT-4.5V-Z |  |
|                     | 6 V DC               | TXS2SA-6V-Z        |  | TXS2SA-LT-6V-Z   |  |
|                     | 9 V DC               | TXS2SA-9V-Z        |  | TXS2SA-LT-9V-Z   |  |
|                     | 12 V DC              | TXS2SA-12V-Z       |  | TXS2SA-LT-12V-Z  |  |
|                     | 24 V DC              | TXS2SA-24V-Z       |  | TXS2SA-LT-24V-Z  |  |

Standard packing: Tape and reel: 500 pcs.; Case: 1,000 pcs.

Notes: 1. Tape and reel packing symbol "-Z" is not marked on the relay. "X" type tape and reel packing (picked from 1/2/3/4-pin side) is also available.

2. Please add "-1" to the end of the part number for AgPd contacts (low level load). (Ex. TXS2SA-3V-1-Z)

## RATING

### 1. Coil data

#### 1) Single side stable

| Nominal coil voltage | Pick-up voltage (at 20°C 68°F)             | Drop-out voltage (at 20°C 68°F)            | Nominal operating current [±10%] (at 20°C 68°F) |  | Coil resistance [±10%] (at 20°C 68°F) |  | Nominal operating power | Max. applied voltage (at 20°C 68°F) |
|----------------------|--|--|---|--|---------------------------------------|--|-------------------------|-------------------------------------|
| 3 V DC               | 80%V or less of nominal voltage* (Initial) | 10%V or more of nominal voltage* (Initial) | 16.7 mA   |  | 180 Ω                                 |  | 50 mW                   | 150%V of nominal voltage            |
| 4.5 V DC             |  |  | 11.1 mA   |  | 405 Ω                                 |  |                         |                                     |
| 6 V DC               |  |  | 8.3 mA  |  | 720 Ω                                 |  |                         |                                     |
| 9 V DC               |  |  | 5.6 mA  |  | 1,620 Ω                               |  |                         |                                     |
| 12 V DC              |  |  | 4.2 mA  |  | 2,880 Ω                               |  |                         |                                     |
| 24 V DC              |  |  | 2.9 mA  |  | 8,229 Ω                               |  | 70 mW                   |                                     |

#### 2) 2 coil latching

| Nominal coil voltage | Set voltage (at 20°C 68°F)                 | Reset voltage (at 20°C 68°F)               | Nominal operating current [±10%] (at 20°C 68°F) |            | Coil resistance [±10%] (at 20°C 68°F) |            | Nominal operating power |            | Max. applied voltage (at 20°C 68°F) |
|----------------------|--|--|---|------------|---------------------------------------|------------|-------------------------|------------|-------------------------------------|
|                      |  |  | Set coil  | Reset coil | Set coil                              | Reset coil | Set coil                | Reset coil |                                     |
| 3 V DC               | 80%V or less of nominal voltage* (Initial) | 80%V or less of nominal voltage* (Initial) | 23.3 mA   | 23.3 mA    | 129 Ω                                 | 129 Ω      | 70 mW                   | 70 mW      | 150%V of nominal voltage            |
| 4.5 V DC             |  |  | 15.6 mA   | 15.6 mA    | 289 Ω                                 | 289 Ω      |                         |            |                                     |
| 6 V DC               |  |  | 11.7 mA   | 11.7 mA    | 514 Ω                                 | 514 Ω      |                         |            |                                     |
| 9 V DC               |  |  | 7.8 mA  | 7.8 mA     | 1,157 Ω                               | 1,157 Ω    |                         |            |                                     |
| 12 V DC              |  |  | 5.8 mA  | 5.8 mA     | 2,057 Ω                               | 2,057 Ω    |                         |            |                                     |
| 24 V DC              |  |  | 6.3 mA  | 6.3 mA     | 3,840 Ω                               | 3,840 Ω    | 150 mW                  | 150 mW     |                                     |

\*Pulse drive (JIS C 5442-1986)

2. Specifications

| Characteristics                          | Item   | Specifications   |   |
|--|--|--|---|
| Contact                                  | Arrangement  | 2 Form C   |   |
|  | Initial contact resistance, max.   | Max. 100 mΩ (By voltage drop 6 V DC 1A)  |   |
|  | Contact material   | Standard contact: Ag+Au clad,<br>AgPd contact (low level load): AgPd+Au clad (stationary), AgPd (movable)                        |   |
| Rating                                   | Nominal switching capacity   | 1 A 30 V DC (resistive load)   |   |
|  | Max. switching power   | 30 W (DC) (resistive load)   |   |
|  | Max. switching voltage   | 110V DC  |   |
|  | Max. switching current   | 1 A  |   |
|  | Min. switching capacity (Reference value)*1  | 10μA 10mV DC   |   |
|  | Nominal operating power  | Single side stable 50 mW (3 to 12 V DC), 70 mW (24 V DC)<br>2 coil latching 70 mW (3 to 12 V DC), 150 mW (24 V DC)               |   |
| Electrical characteristics               | Insulation resistance (Initial)  | Min. 1,000MΩ (at 500V DC) Measurement at same location as "Initial breakdown voltage" section.                                   |   |
|  | Breakdown voltage (Initial)  | Between open contacts  | 750 Vrms for 1min. (Detection current: 10mA)  |
|  |  | Between contact and coil   | 1,800 Vrms for 1min. (Detection current: 10mA)  |
|  |  | Between contact sets   | 1,000 Vrms for 1min. (Detection current: 10mA)  |
|  | Surge breakdown voltage (Initial)  | Between open contacts  | 1,500 V (10×160μs) (FCC Part 68)  |
|  |  | Between contacts and coil  | 2,500 V (2×10μs) (Telcordia)  |
|  | Temperature rise (at 20°C 68°F)  | Max. 50°C<br>(By resistive method, nominal coil voltage applied to the coil; contact carrying current: 1A.)                      |   |
|  | Operate time [Set time] (at 20°C 68°F)   | Max. 5 ms [Max. 5 ms] (Nominal coil voltage applied to the coil, excluding contact bounce time.)                                 |   |
| Release time [Reset time] (at 20°C 68°F) | Max. 5 ms [Max. 5 ms] (Nominal coil voltage applied to the coil, excluding contact bounce time.) (without diode) |  |   |
| Mechanical characteristics               | Shock resistance   | Functional   | Min. 750 m/s <sup>2</sup> (Half-wave pulse of sine wave: 6 ms; detection time: 10μs.) |
|  |  | Destructive  | Min. 1,000 m/s <sup>2</sup> (Half-wave pulse of sine wave: 6 ms.)                     |
|  | Vibration resistance   | Functional   | 10 to 55 Hz at double amplitude of 3.3 mm (Detection time: 10μs.)                     |
|  |  | Destructive  | 10 to 55 Hz at double amplitude of 5 mm   |
| Expected life                            | Mechanical   | Min. 5×10 <sup>7</sup> (at 180 cpm)  |   |
|  | Electrical (Standard contact)  | Min. 2×10 <sup>5</sup> (1 A 30 V DC resistive) (at 20 cpm)   |   |
| Conditions                               | Conditions for operation, transport and storage*2  | Ambient temperature: -40°C to +70°C -40°F to +158°F;<br>Humidity: 5 to 85% R.H. (Not freezing and condensing at low temperature) |   |
|  | Max. operating speed (at rated load)   | 20 cpm   |   |
| Unit weight                              |  | Approx. 2 g .071 oz  |   |

Notes: \*1 This value can change due to the switching frequency, environmental conditions, and desired reliability level, therefore it is recommended to check this with the actual load. AgPd contact type is available for low level load switching (10V DC, 10mA max. level).  
\*2 Refer to "AMBIENT ENVIRONMENT" in GENERAL APPLICATION GUIDELINES.

REFERENCE DATA

1. Maximum switching capacity



2. Life curve



3. Mechanical life

Tested sample: TXS2-4.5V, 10 pcs.  
Operating speed: 180 cpm



4. Electrical life (1 A 30 V DC resistive load)

Tested sample: TXS2-4.5V, 6 pcs.

Operating speed: 20 cpm

Change of pick-up and drop-out voltage

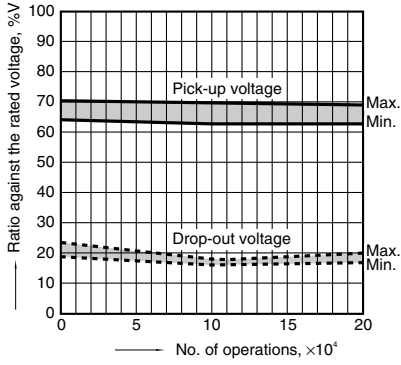

Change of contact resistance

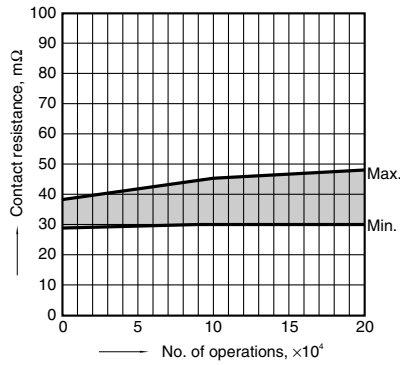

5-(1). Coil temperature rise

Tested sample: TXS2-4.5V, 6 pcs.

Point measured: Inside the coil

Ambient temperature: 25°C 77°F, 70°C 158°F

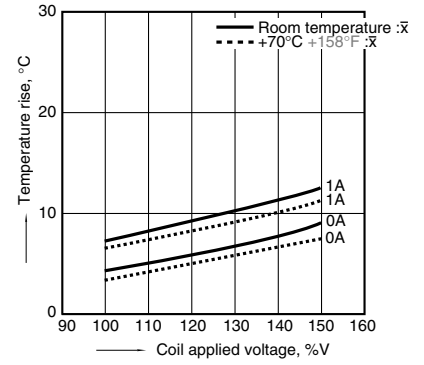

5-(2). Coil temperature rise

Tested sample: TXS2-24V, 6 pcs.

Point measured: Inside the coil

Ambient temperature: 25°C 77°F, 70°C 158°F

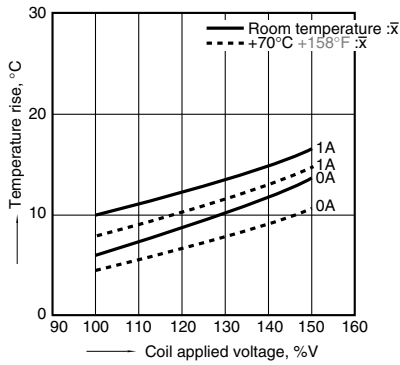

6-(1). Operate and release time (with diode)

Tested sample: TXS2-4.5V, 10 pcs.

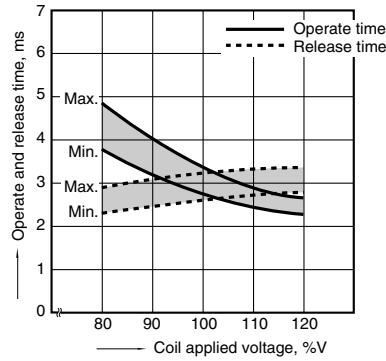

6-(2). Operate and release time (without diode)

Tested sample: TXS2-4.5V, 10 pcs.

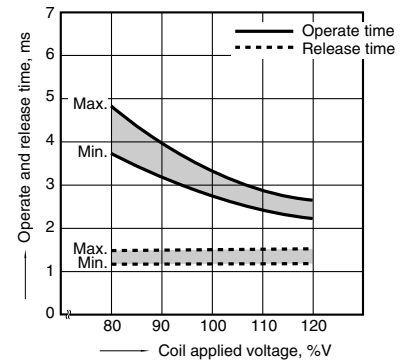

7. Ambient temperature characteristics

Tested sample: TXS2-4.5V, 5 pcs.

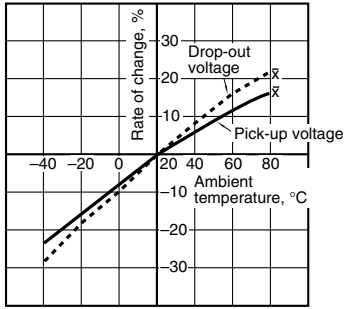

8-(1). High frequency characteristics (Isolation)

Tested sample: TXS2-4.5V, 2 pcs.

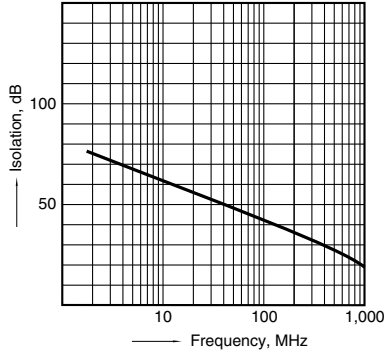

8-(2). High frequency characteristics (Insertion loss)

Tested sample: TXS2-4.5V, 2 pcs.

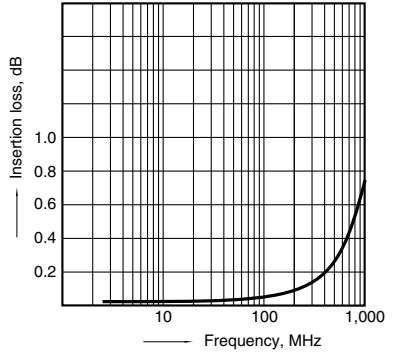

9-(1). Malfunctional shock (single side stable)

Tested sample: TXS2-4.5V, 6 pcs.



9-(2). Malfunctional shock (latching)

Tested sample: TXS2-LT-4.5V, 6 pcs.



10. Thermal electromotive force

Tested sample: TXS2-4.5V, 10 pcs.

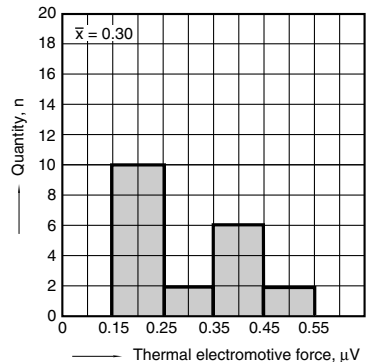

11-(1). Influence of adjacent mounting  
Tested sample: TXS2-4.5V, 6 pcs.



11-(2). Influence of adjacent mounting  
Tested sample: TXS2-4.5V, 6 pcs.



11-(3). Influence of adjacent mounting  
Tested sample: TXS2-4.5V, 6 pcs.



12. Pulse dialing test  
(35 mA 48V DC wire spring relay load)  
Tested sample: TXS2-4.5V, 6 pcs.



Change of pick-up and drop-out voltage



Change of contact resistance



Note: Data of surface-mount type are the same as those of PC board terminal type.

**DIMENSIONS** (mm inch) The CAD data of the products with a **CAD Data** mark can be downloaded from: <http://industrial.panasonic.com/ac/e/>

**1. Standard PC board terminal and Self clinching terminal**

**CAD Data**



| Type                       | External dimensions (General tolerance: $\pm 0.3 \pm 0.12$ ) |                      | PC board pattern (Bottom view) (Tolerance: $\pm 0.1 \pm 0.04$ ) |                      |
|----------------------------|--|----------------------|---|----------------------|
|                            | Single side stable type                                      | 2 coil latching type | Single side stable type   | 2 coil latching type |
| Standard PC board terminal |  |                      |   |                      |

**Schematic (Bottom view)**



2. Surface-mount terminal

CAD Data



| Type    | External dimensions (General tolerance: $\pm 0.3 \pm 0.12$ ) |                      | Suggested mounting pad (Top view) (Tolerance: $\pm 0.1 \pm 0.04$ ) |                      |
|---------|--|----------------------|--|----------------------|
|         | Single side stable type                                      | 2 coil latching type | Single side stable type  | 2 coil latching type |
| SA type |  |                      |  |                      |

Schematic (Top view)

Single side stable

2 coil latching



(Deenergized condition)

(Reset condition)

NOTES

1. Packing style

1) The relay is packed in a tube with the relay orientation mark on the left side, as shown in the figure below.



2) Tape and reel packing (surface-mount terminal type)

(1) Tape dimensions

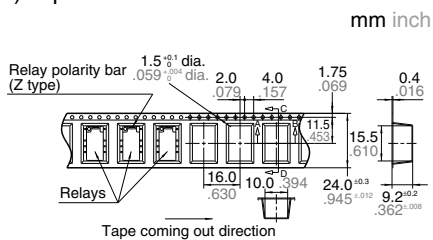

(2) Dimensions of plastic reel

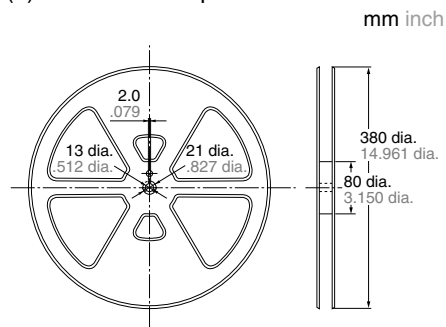

2. Automatic insertion

To maintain the internal function of the relay, the chucking pressure should not exceed the values below.

Chucking pressure in the direction A: 4.9 N {500gf} or less

Chucking pressure in the direction B: 9.8 N {1 kgf} or less

Chucking pressure in the direction C: 9.8 N {1 kgf} or less



Please chuck the portion. Avoid chucking the center of the relay. In addition, excessive chucking pressure to the pinpoint of the relay should be avoided.

For general cautions for use, please refer to the "Cautions for use of Signal Relays" or "General Application Guidelines".