



## FEATURES

- **Compact size**
- **Perfect for automobile electrical systems**  
Over  $2 \times 10^5$  openings possible with a 14 V DC motor load, an inrush current of 25 A, and steady state current of 5 A. (N.O. side)
- **Standard terminal pitch employed**  
The terminal array used is identical to that used in small automotive relays.
- **Plastic sealed type.**  
Plastically sealed for automatic cleaning.
- **Line-up of 1 Form A and 1 Form C**

## TYPICAL APPLICATIONS

- Power windows
- Auto door lock
- Electrically powered sun roof
- Electrically powered mirror
- Cornering lamp, etc.

## ORDERING INFORMATION

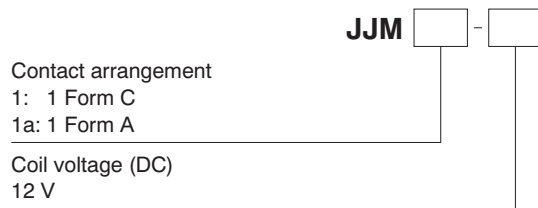

## TYPES

Contact arrangement	Coil voltage	Part No.
1 Form A	12 V DC	JJM1a-12V
1 Form C	12 V DC	JJM1-12V

Standard packing; Carton (tube): 50 pcs.; Case: 1,000 pcs.

## RATING

### 1. Coil data

Nominal coil voltage	Pick-up voltage (at 20°C 68°F)	Drop-out voltage (at 20°C 68°F)	Nominal operating current [±10%] (at 20°C 68°F)	Coil resistance [±10%] (at 20°C 68°F)	Nominal operating power (at 20°C 68°F)	Usable voltage range
12V DC	Max. 7.2 V DC (Initial)	Min. 1.0 V DC (Initial)	53.3 mA	225Ω	640 mW	10 to 16V DC

Note: Other pick-up voltage types are also available. Please contact us for details.

## 2. Specifications

Characteristics	Item		Specifications	
			1 Form A	1 Form C
Contact	Arrangement		1 Form A	
	Contact resistance (Initial)		Typ 5mΩ (By voltage drop 6V DC 1A)	
	Contact material		Ag alloy (Cadmium free)	
Rating	Nominal switching capacity (resistive load)		20 A 14V DC	N.O.: 20 A 14V DC N.C.: 10 A 14V DC
	Max. carrying current (12V DC)*3		N.O.: 35 A (at 20°C 68°F for 2 minutes), 25 A (at 20°C 68°F for 1 hour), 30 A (at 85°C 185°F for 2 minutes), 20 A (at 85°C 185°F for 1 hour)	
	Nominal operating power		640 mW	
	Min. switching capacity (resistive load)*1		1 A 12V DC	
Electrical characteristics	Insulation resistance (Initial)		Min. 100 MΩ (at 500V DC, Measurement at same location as "Break down voltage" section)	
	Breakdown voltage (Initial)	Between open contacts	500 Vrms for 1 min. (Detection current: 10mA)	
		Between contacts and coil	500 Vrms for 1 min. (Detection current: 10mA)	
	Operate time (at nominal voltage)		Max. 10ms (at 20°C 68°F, excluding contact bounce time) (Initial)	
	Release time (at nominal voltage)		Max. 10ms (at 20°C 68°F, excluding contact bounce time) (Initial)	
Mechanical characteristics	Shock resistance	Functional	Min. 100 m/s <sup>2</sup> {10G} (Half-wave pulse of sine wave: 11ms; detection time: 10μs)	
		Destructive	Min. 1,000 m/s <sup>2</sup> {100G} (Half-wave pulse of sine wave: 6ms)	
	Vibration resistance	Functional	10 Hz to 100 Hz, Min. 44.1 m/s <sup>2</sup> {4.5G} (Detection time: 10μs)	
		Destructive	10 Hz to 500 Hz, Min. 44.1 m/s <sup>2</sup> {4.5G}, Time of vibration for each direction; X, Y direction: 2 hours, Z direction: 4 hours	
Expected life	Mechanical		Min. 10 <sup>7</sup> (at 120 cpm)	
	Electrical		<Resistive load> Min. 10 <sup>5</sup> (at nominal switching capacity) (operating frequency: 1s ON, 9s OFF) <Motor load> Min. 2 × 10 <sup>5</sup> (at Inrush 25A, Steady 5A 14 V DC) Min. 5 × 10 <sup>4</sup> (at 20A 14 V DC motor lock) (operating frequency: 0.5s ON, 9.5s OFF)	<Resistive load> N.O.: Min. 10 <sup>5</sup> (at nominal switching capacity) N.C.: Min. 10 <sup>5</sup> (at nominal switching capacity) (operating frequency: 1s ON, 9s OFF) <Motor load> N.O.: Min. 2 × 10 <sup>5</sup> (at Inrush 25A, Steady 5A 14 V DC), Min. 5 × 10 <sup>4</sup> (at 20A 14 V DC motor lock) N.C.: Min. 2 × 10 <sup>5</sup> (at 20A 14 V DC brake correct) (operating frequency: 0.5s ON, 9.5s OFF)
Conditions	Conditions for operation, transport and storage*2		Ambient temperature: -40°C to +85°C -40°F to +185°F, Humidity: 5% R.H. to 85% R.H. (Not freezing and condensing at low temperature)	
	Max. operating speed		6 cpm (at nominal switching capacity)	
Mass			Approx. 5g .176 oz	

### Notes:

\*1. This value can change due to the switching frequency, environmental conditions, and desired reliability level, therefore it is recommended to check this with the actual load.

\*2. The upper operation ambient temperature limit is the maximum temperature that can satisfy the coil temperature rise value. Refer to "6. Usage, Storage and Transport Conditions" in [AMBIENT ENVIRONMENT section in Relay Technical Information](#).

Please inquire if you will be using the relay in a high temperature atmosphere (110°C 230°F).

\*3. Depends on connection conditions. Also, this does not guarantee repeated switching. We recommend that you confirm operation under actual conditions.

## REFERENCE DATA

### 1. Coil temperature rise

Sample: JJM1-12V, 6pcs

Point measured: Inside the coil

Contact current: Non current through

contact, 5A, 10A, 15A, 20A

Resistance method, ambient temperature 85°C 185°F

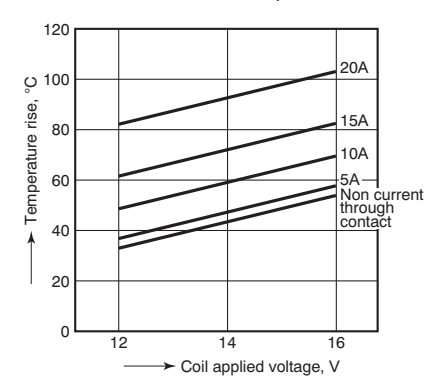

### 2. Max. switching capability (Resistive load, initial)

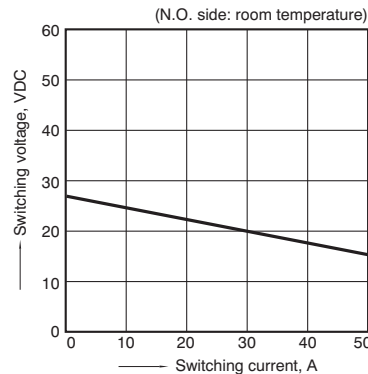

### 3. Ambient temperature and operating voltage range

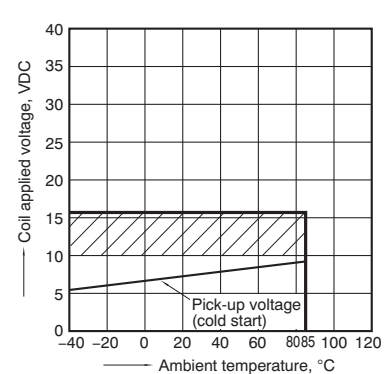

4. Distribution of pick-up and drop-out voltage  
Sample: JJM1-12V, 100pcs

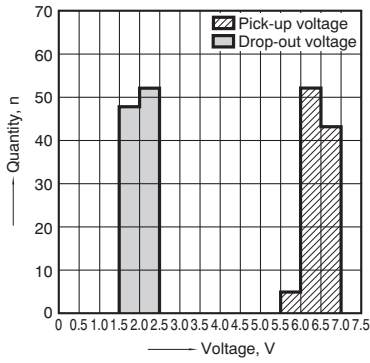

5. Distribution of operate time  
Sample: JJM1-12V, 100pcs

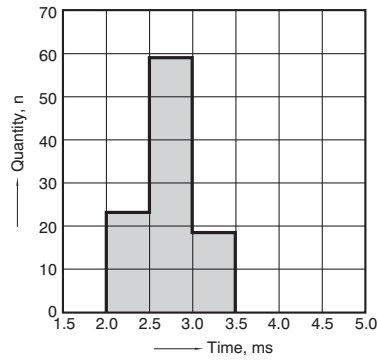

6. Distribution of release time  
Sample: JJM1-12V, 100pcs  
\* Without diode

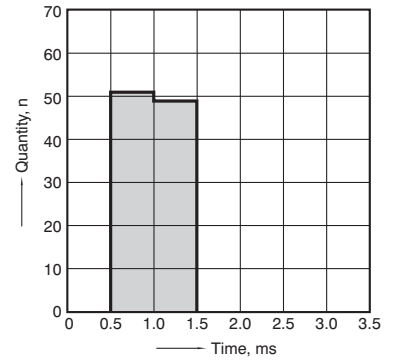

7-(1). Electrical life test (at resistive load)

Sample: JJM1-12V  
Quantity: n = 6 (NC = 3, NO = 3)  
Load: Resistive load (NC side: 10A 14 V DC, NO side: 20 A 14 V DC); Operating frequency: ON 1s, OFF 9s  
Ambient temperature: Room temperature

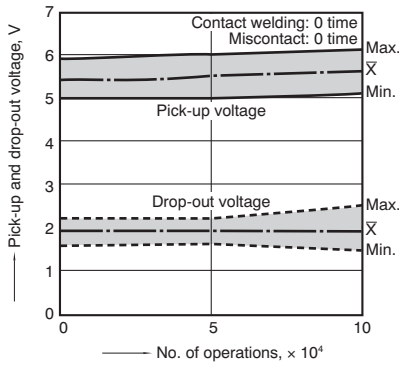

7-(2). Electrical life test (Motor free)

Sample: JJM1-12V, 6pcs.  
Load: Inrush 25A, Steady 5A, Brake current 18A 14V DC, Power window motor load (Free condition).  
Operating frequency: ON 0.5s, OFF 9.5s  
Ambient temperature: Room temperature

Circuit :

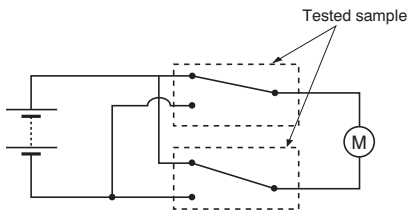

Change of pick-up and drop-out voltage

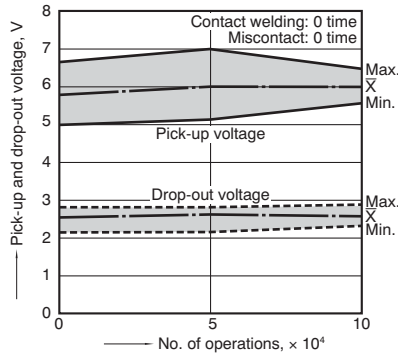

Change of contact resistance

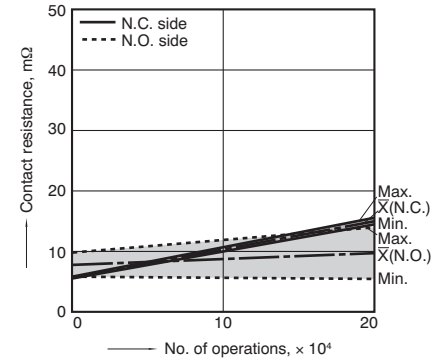

7-(3). Electrical life test (Motor lock)

Sample: JJM1-12V, 6pcs.  
Load: 20A, 14VDC, Power window motor actual load (lock condition).  
Operating frequency: ON 1s, OFF 5s  
Ambient temperature: Room temperature

Circuit :

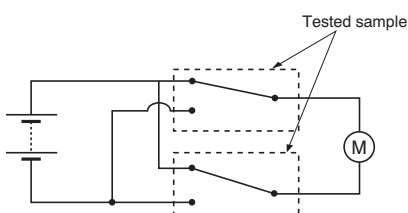

Change of pick-up and drop-out voltage

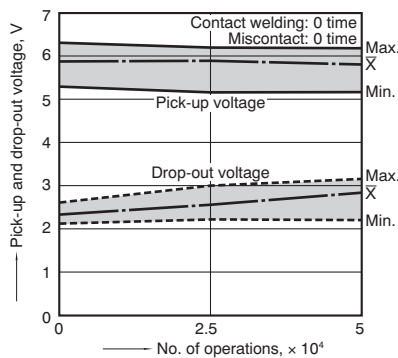

Change of contact resistance

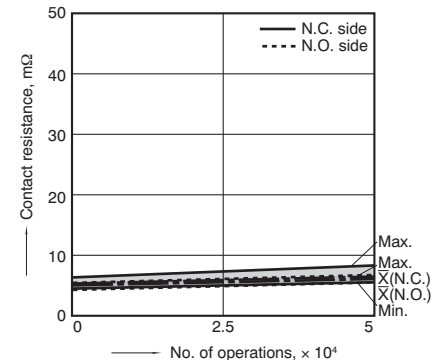

## 7-(4). Electrical life test (Lamp load)

Sample: JJM1-12V, 6pcs.

Load: 27W+21W, steady min. 4A, Lamp actual load

Operating frequency: ON 2s, OFF 13s

Ambient temperature: Room temperature

Circuit :

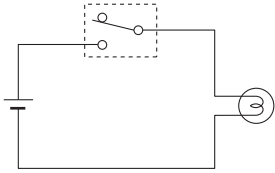

## Change of pick-up and drop-out voltage

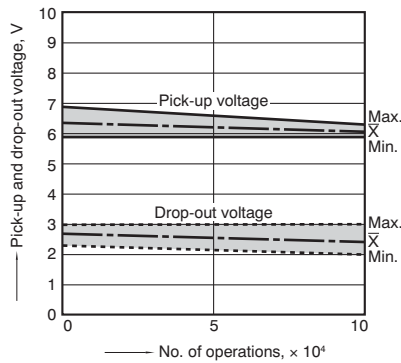

## Change of contact resistance

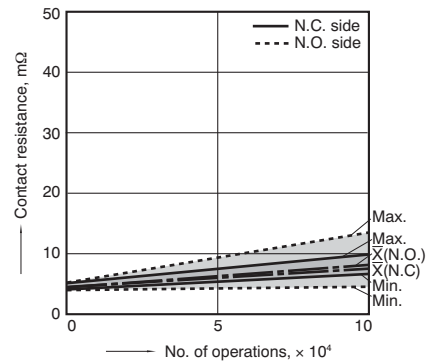

## Load current waveform

Inrush current: 42A, Steady current: 4.4A

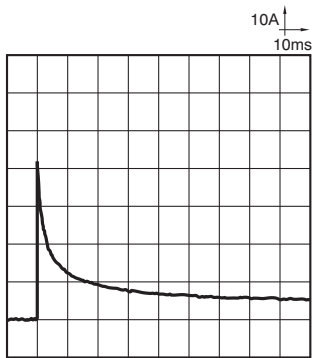

## DIMENSIONS (mm inch)

Download [CAD Data](#) from our Web site.

[CAD Data](#)



### External dimensions

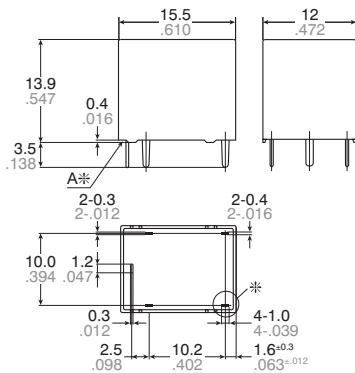

### Schematic (Bottom view)

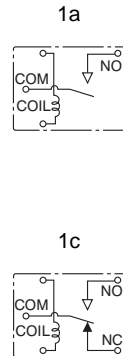

### PC board pattern (Bottom view)

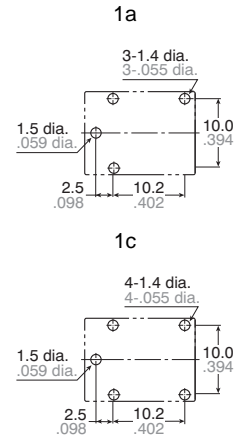

\* Dimensions (thickness and width) of terminal is measured before pre-soldering.  
Intervals between terminals is measured at A surface level.

Dimension:	General tolerance
Max. 1mm .039 inch:	±0.1 ±.004
1 to 3mm .039 to .118 inch:	±0.2 ±.008
Min. 3mm .118 inch:	±0.3 ±.012

Tolerance: ±0.1 ±.004

Note: \* Marked terminal is only for 1 Form C type

For Cautions for Use, see [Relay Technical Information](#).