

SEALED CONSTRUCTION
High reliability ensured in
challenging environments.

HC RELAYS
AMBER SEALED TYPE



Plug-in type



PC board type



TM type

FEATURES

1. Even when left for long periods in challenging environments, resistance values for the contacts remain stable.
 2. Compact yet compatible all over the world.
 3. Can be used in a wide variety of applications.
 4. With LED indication type also available
 5. External dimensions and mounting dimensions same as for HC relays
 6. **UL, CSA approval is standard**
- Connection accessories (terminal sockets and sockets) also shared.
Compliance also with Japanese Electrical Appliance and Material Control Law.

TYPICAL APPLICATIONS

1. Where surrounding atmosphere is bad
Cotton mills, flour mills, chemical works, traffic signals, etc.
2. In situations where high reliability is required
Safety equipment, alarms, copiers, telecommunications devices, computers, etc.

About Cd-free contacts

We have introduced Cadmium free type products to reduce Environmental Hazardous Substances. (The suffix "F" should be added to the part number. The Suffix "F" is required only for 1 Form C, 2 Form C contact type. The 4 Form C and 4 Form C bifurcated (twin) contact type is originally cadmium-free, the suffix "F" is not required.)

Please replace parts containing Cadmium with Cadmium-free products and evaluate them with your actual application before use because the life of a relay depends on the contact material and load.

Compliance with RoHS Directive

ORDERING INFORMATION

HC - - - -

Contact arrangement

- 1: 1 Form C
- 2: 2 Form C
- 4: 4 Form C

E: Amber sealed type

ED: Amber sealed type bifurcated contact (twin) (Only 4 Form C)

Terminal arrangement

- H: Plug-in type
- L: Plug-in with LED indication
- HP: PC board type
- PL: PC board with LED indication
- HTM: TM type

Coil voltage

AC 6, 12, 24, 48, 100 (100/110), 120 (110/120), 200 (200/220), 240 (220/240) V
DC 6, 12, 24, 48, 100 (100/110) V

Contact material

Contact arrangement	Contact material	AgSnO ₂ type	AgNi type
1 Form C		F	
2 Form C		F	
4 Form C			Nil
4-pole bifurcated (twin)			Nil

Note: UL/CSA approved type is standard.

HC

TYPES

1) Plug-in type

Coil voltage	1 Form C	2 Form C	4 Form C	4 Form C (twin)
	Part No.	Part No.	Part No.	Part No.
6V AC	HC1E-H-AC6V-F	HC2E-H-AC6V-F	HC4E-H-AC6V	HC4ED-H-AC6V
12V AC	HC1E-H-AC12V-F	HC2E-H-AC12V-F	HC4E-H-AC12V	HC4ED-H-AC12V
24V AC	HC1E-H-AC24V-F	HC2E-H-AC24V-F	HC4E-H-AC24V	HC4ED-H-AC24V
48V AC	HC1E-H-AC48V-F	HC2E-H-AC48V-F	HC4E-H-AC48V	HC4ED-H-AC48V
100/110V AC	HC1E-H-AC100V-F	HC2E-H-AC100V-F	HC4E-H-AC100V	HC4ED-H-AC100V
110/120V AC	HC1E-H-AC120V-F	HC2E-H-AC120V-F	HC4E-H-AC120V	HC4ED-H-AC120V
200/220V AC	HC1E-H-AC200V-F	HC2E-H-AC200V-F	HC4E-H-AC200V	HC4ED-H-AC200V
220/240V AC	HC1E-H-AC240V-F	HC2E-H-AC240V-F	HC4E-H-AC240V	HC4ED-H-AC240V
6V DC	HC1E-H-DC6V-F	HC2E-H-DC6V-F	HC4E-H-DC6V	HC4ED-H-DC6V
12V DC	HC1E-H-DC12V-F	HC2E-H-DC12V-F	HC4E-H-DC12V	HC4ED-H-DC12V
24V DC	HC1E-H-DC24V-F	HC2E-H-DC24V-F	HC4E-H-DC24V	HC4ED-H-DC24V
48V DC	HC1E-H-DC48V-F	HC2E-H-DC48V-F	HC4E-H-DC48V	HC4ED-H-DC48V
100/110V DC	HC1E-H-DC100V-F	HC2E-H-DC100V-F	HC4E-H-DC100V	HC4ED-H-DC100V

Standard packing: Carton: 20 pcs.; Case: 200 pcs.

2) Plug-in type (With LED indication)

Coil voltage	1 Form C	2 Form C	4 Form C	4 Form C (twin)
	Part No.	Part No.	Part No.	Part No.
6V AC	HC1E-L-AC6V-F	HC2E-L-AC6V-F	HC4E-L-AC6V	HC4ED-L-AC6V
12V AC	HC1E-L-AC12V-F	HC2E-L-AC12V-F	HC4E-L-AC12V	HC4ED-L-AC12V
24V AC	HC1E-L-AC24V-F	HC2E-L-AC24V-F	HC4E-L-AC24V	HC4ED-L-AC24V
48V AC	HC1E-L-AC48V-F	HC2E-L-AC48V-F	HC4E-L-AC48V	HC4ED-L-AC48V
100/110V AC	HC1E-L-AC100V-F	HC2E-L-AC100V-F	HC4E-L-AC100V	HC4ED-L-AC100V
110/120V AC	HC1E-L-AC120V-F	HC2E-L-AC120V-F	HC4E-L-AC120V	HC4ED-L-AC120V
200/220V AC	HC1E-L-AC200V-F	HC2E-L-AC200V-F	HC4E-L-AC200V	HC4ED-L-AC200V
220/240V AC	HC1E-L-AC240V-F	HC2E-L-AC240V-F	HC4E-L-AC240V	HC4ED-L-AC240V
6V DC	HC1E-L-DC6V-F	HC2E-L-DC6V-F	HC4E-L-DC6V	HC4ED-L-DC6V
12V DC	HC1E-L-DC12V-F	HC2E-L-DC12V-F	HC4E-L-DC12V	HC4ED-L-DC12V
24V DC	HC1E-L-DC24V-F	HC2E-L-DC24V-F	HC4E-L-DC24V	HC4ED-L-DC24V
48V DC	HC1E-L-DC48V-F	HC2E-L-DC48V-F	HC4E-L-DC48V	HC4ED-L-DC48V
100/110V DC	HC1E-L-DC100V-F	HC2E-L-DC100V-F	HC4E-L-DC100V	HC4ED-L-DC100V

Standard packing: Carton: 20 pcs.; Case: 200 pcs.

3) PC board type

Coil voltage	1 Form C	2 Form C	4 Form C	4 Form C (twin)
	Part No.	Part No.	Part No.	Part No.
6V AC	HC1E-HP-AC6V-F	HC2E-HP-AC6V-F	HC4E-HP-AC6V	HC4ED-HP-AC6V
12V AC	HC1E-HP-AC12V-F	HC2E-HP-AC12V-F	HC4E-HP-AC12V	HC4ED-HP-AC12V
24V AC	HC1E-HP-AC24V-F	HC2E-HP-AC24V-F	HC4E-HP-AC24V	HC4ED-HP-AC24V
48V AC	HC1E-HP-AC48V-F	HC2E-HP-AC48V-F	HC4E-HP-AC48V	HC4ED-HP-AC48V
100/110V AC	HC1E-HP-AC100V-F	HC2E-HP-AC100V-F	HC4E-HP-AC100V	HC4ED-HP-AC100V
110/120V AC	HC1E-HP-AC120V-F	HC2E-HP-AC120V-F	HC4E-HP-AC120V	HC4ED-HP-AC120V
200/220V AC	HC1E-HP-AC200V-F	HC2E-HP-AC200V-F	HC4E-HP-AC200V	HC4ED-HP-AC200V
220/240V AC	HC1E-HP-AC240V-F	HC2E-HP-AC240V-F	HC4E-HP-AC240V	HC4ED-HP-AC240V
6V DC	HC1E-HP-DC6V-F	HC2E-HP-DC6V-F	HC4E-HP-DC6V	HC4ED-HP-DC6V
12V DC	HC1E-HP-DC12V-F	HC2E-HP-DC12V-F	HC4E-HP-DC12V	HC4ED-HP-DC12V
24V DC	HC1E-HP-DC24V-F	HC2E-HP-DC24V-F	HC4E-HP-DC24V	HC4ED-HP-DC24V
48V DC	HC1E-HP-DC48V-F	HC2E-HP-DC48V-F	HC4E-HP-DC48V	HC4ED-HP-DC48V
100/110V DC	HC1E-HP-DC100V-F	HC2E-HP-DC100V-F	HC4E-HP-DC100V	HC4ED-HP-DC100V

Standard packing: Carton: 20 pcs.; Case: 200 pcs.

Note: The PC board 0.9 mm width terminal type is also available, please part number. suffix "31" is needed when ordering (4 Form C, 4 Form C (twin) only)

4) PC board type (With LED indication)

Coil voltage	1 Form C	2 Form C	4 Form C	4 Form C (twin)
	Part No.	Part No.	Part No.	Part No.
6V AC	HC1E-PL-AC6V-F	HC2E-PL-AC6V-F	HC4E-PL-AC6V	HC4ED-PL-AC6V
12V AC	HC1E-PL-AC12V-F	HC2E-PL-AC12V-F	HC4E-PL-AC12V	HC4ED-PL-AC12V
24V AC	HC1E-PL-AC24V-F	HC2E-PL-AC24V-F	HC4E-PL-AC24V	HC4ED-PL-AC24V
48V AC	HC1E-PL-AC48V-F	HC2E-PL-AC48V-F	HC4E-PL-AC48V	HC4ED-PL-AC48V
100/110V AC	HC1E-PL-AC100V-F	HC2E-PL-AC100V-F	HC4E-PL-AC100V	HC4ED-PL-AC100V
110/120V AC	HC1E-PL-AC120V-F	HC2E-PL-AC120V-F	HC4E-PL-AC120V	HC4ED-PL-AC120V
200/220V AC	HC1E-PL-AC200V-F	HC2E-PL-AC200V-F	HC4E-PL-AC200V	HC4ED-PL-AC200V
220/240V AC	HC1E-PL-AC240V-F	HC2E-PL-AC240V-F	HC4E-PL-AC240V	HC4ED-PL-AC240V
6V DC	HC1E-PL-DC6V-F	HC2E-PL-DC6V-F	HC4E-PL-DC6V	HC4ED-PL-DC6V
12V DC	HC1E-PL-DC12V-F	HC2E-PL-DC12V-F	HC4E-PL-DC12V	HC4ED-PL-DC12V
24V DC	HC1E-PL-DC24V-F	HC2E-PL-DC24V-F	HC4E-PL-DC24V	HC4ED-PL-DC24V
48V DC	HC1E-PL-DC48V-F	HC2E-PL-DC48V-F	HC4E-PL-DC48V	HC4ED-PL-DC48V
100/110V DC	HC1E-PL-DC100V-F	HC2E-PL-DC100V-F	HC4E-PL-DC100V	HC4ED-PL-DC100V

Standard packing: Carton: 20 pcs.; Case: 200 pcs.

Note: The PC board 0.9 mm width terminal type is also available, please part number. suffix "31" is needed when ordering (4 Form C, 4 Form C (twin) only)

5) TM type

Coil voltage	1 Form C	2 Form C	4 Form C	4 Form C (twin)
	Part No.	Part No.	Part No.	Part No.
6V AC	HC1E-HTM-AC6V-F	HC2E-HTM-AC6V-F	HC4E-HTM-AC6V	HC4ED-HTM-AC6V
12V AC	HC1E-HTM-AC12V-F	HC2E-HTM-AC12V-F	HC4E-HTM-AC12V	HC4ED-HTM-AC12V
24V AC	HC1E-HTM-AC24V-F	HC2E-HTM-AC24V-F	HC4E-HTM-AC24V	HC4ED-HTM-AC24V
48V AC	HC1E-HTM-AC48V-F	HC2E-HTM-AC48V-F	HC4E-HTM-AC48V	HC4ED-HTM-AC48V
100/110V AC	HC1E-HTM-AC100V-F	HC2E-HTM-AC100V-F	HC4E-HTM-AC100V	HC4ED-HTM-AC100V
110/120V AC	HC1E-HTM-AC120V-F	HC2E-HTM-AC120V-F	HC4E-HTM-AC120V	HC4ED-HTM-AC120V
200/220V AC	HC1E-HTM-AC200V-F	HC2E-HTM-AC200V-F	HC4E-HTM-AC200V	HC4ED-HTM-AC200V
220/240V AC	HC1E-HTM-AC240V-F	HC2E-HTM-AC240V-F	HC4E-HTM-AC240V	HC4ED-HTM-AC240V
6V DC	HC1E-HTM-DC6V-F	HC2E-HTM-DC6V-F	HC4E-HTM-DC6V	HC4ED-HTM-DC6V
12V DC	HC1E-HTM-DC12V-F	HC2E-HTM-DC12V-F	HC4E-HTM-DC12V	HC4ED-HTM-DC12V
24V DC	HC1E-HTM-DC24V-F	HC2E-HTM-DC24V-F	HC4E-HTM-DC24V	HC4ED-HTM-DC24V
48V DC	HC1E-HTM-DC48V-F	HC2E-HTM-DC48V-F	HC4E-HTM-DC48V	HC4ED-HTM-DC48V
100/110V DC	HC1E-HTM-DC100V-F	HC2E-HTM-DC100V-F	HC4E-HTM-DC100V	HC4ED-HTM-DC100V

Standard packing: Carton: 20 pcs.; Case: 200 pcs.

RATING

1. Coil data (Common for standard types)

2. Specifications

Characteristics	Item	Specifications			
		1 Form C	2 Form C	4 Form C	4 Form C (twin)
Contact	Arrangement	1 Form C	2 Form C	4 Form C	4 Form C
Rating	Nominal switching capacity (resistive load)	5A 250V AC	3A 250V AC	2A 250V AC	1A 250V AC
	Max. switching power (resistive load)	1,250VA	700VA	500VA	250VA
	Max. switching voltage	250VAC	250VAC	250VAC	250VAC
	Max. switching current	5A	3A	2A	1A
	Min. switching capacity (Reference value)*1	1mA 100mV DC			
Electrical characteristics	Temperature rise (at 60°C 140°F)	Max. 90°C (By resistive method, nominal voltage)			
Expected life	Electrical	Min. 2×10 ⁵ resistive load (at 20 cpm)			
Conditions	Conditions for operation, transport and storage*2	Ambient temperature: -40°C to +60°C -40°F to +140°F; Humidity: 5 to 85% R.H. (Not freezing and condensing at low temperature)			
	Ambient air pressure	760mmHg±20% (1,013mb±20%)			

Notes: Other specifications are same as standard types.

*1 This value can change due to the switching frequency, environmental conditions and desired reliability level, therefore it is recommended to check this with the actual load.

*2 The upper operation ambient temperature limit is the maximum temperature that can satisfy the coil temperature rise value. Refer to 6. Conditions for operation, transport and storage mentioned in AMBIENT ENVIRONMENT.

3. Switching capacity and expected life

1) Electrical (at 20 cpm)

Load	AC				DC		Expected life
	Resistive (cos φ = 1)		Inductive (cos φ ≒ 0.4)		Resistive	Inductive	
Voltage	125V AC	250V AC	125V AC	250V AC	30V DC	30V DC	
HC1E	5A	5A	—	—	3A	1A	Min. 2×10 ⁵
HC2E	3A	3A	—	—	2A	1.7A	Min. 2×10 ⁵
HC4E	2A	2A	—	—	2A	0.6A	Min. 2×10 ⁵
HC4ED (4 Form C twin)	1A	1A	—	—	—	—	Min. 2×10 ⁵

2) Mechanical (at 180 cpm)

Min. 5×10⁷ (AC coil type); Min. 10⁸ (DC coil type)

REFERENCE DATA

1.-(1) Switching capacity range
(single contact type)

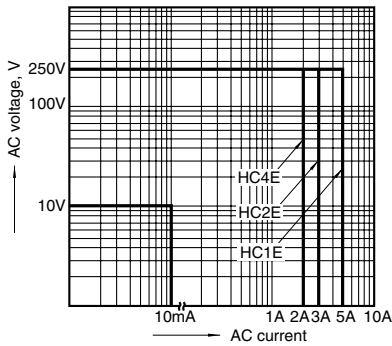

1.-(2) Switching capacity range
(4-pole bifurcated (twin))

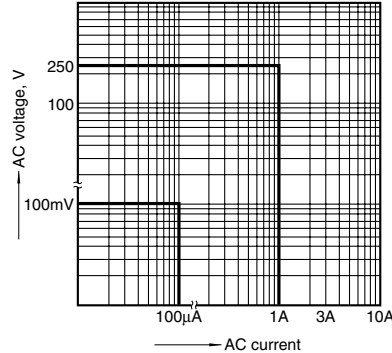

2.-(1) Coil temperature rise (1 Form C AC type)
Measured portion: Inside the coil
Ambient temperature: 30°C 86°F

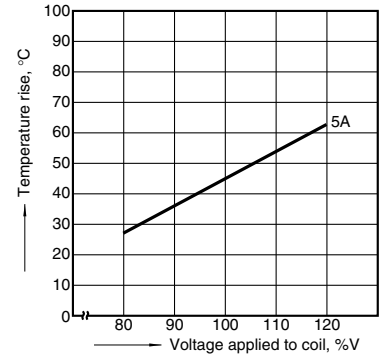

2.-(2) Coil temperature rise (2 Form C AC type)
Measured portion: Inside the coil
Ambient temperature: 30°C 86°F

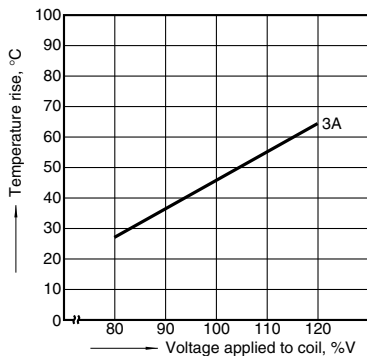

2.-(3) Coil temperature rise (4 Form C AC type)
Measured portion: Inside the coil
Ambient temperature: 30°C 86°F

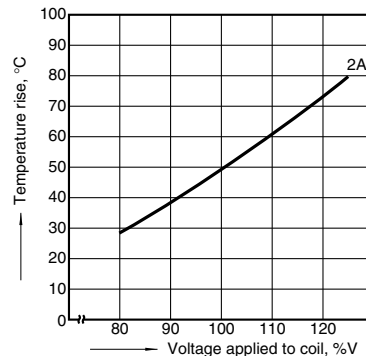

2.-(4) Coil temperature rise (1 Form C DC type)
Measured portion: Inside the coil
Ambient temperature: 30°C 86°F

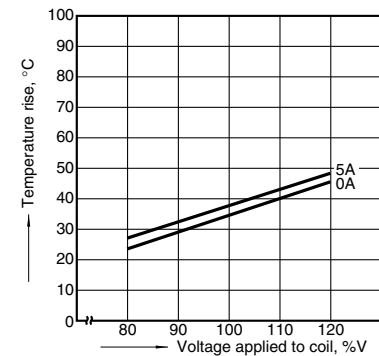

2.-(5) Coil temperature rise (2 Form C DC type)
Measured portion: Inside the coil
Ambient temperature: 30°C 86°F

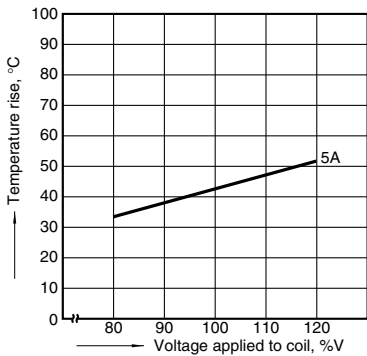

Note: Coil temperature rise

When the nominal voltage is applied to AC 120 or 240 V coil types respectively, the figures of coil temperature rise increase by approx. 10 degrees to the ones shown on each graph.

DIMENSIONS

HC relays are unified to standard sizes. Please refer to standard type information.

NOTES

When mounting TM types, use washers to prevent damage or distortion to the polycarbonate cover. When tightening fixing screws, the optimum torque range should be 0.294 to 0.49 N·m, (3 to 5 kgf·cm). If screws are over tightened, the cover may distort, resulting in poor sealing. Moreover, to prevent loosening, use washers.

For Cautions for Use, see Relay Technical Information.

HC RELAY SOCKETS

1. Plug-in type sockets, PC board type sockets, and wrapping type sockets are available for HC relays.
2. In the table below, the socket suitable for each type of HC relay is indicated by a black dot.
3. UL/CSA approval is standard.

4. A hold-down clip is included in the package.



The fixing method is the same as for HC sockets, ordinary HC terminal sockets and HL sockets.

HC/HL-LEAF-SPRING-MK

Compliance with RoHS Directive

SOCKET SELECTOR CHART

Type	No. of pole	Item	Part No.	Applicable HC relay (Plug-in type)										
				Standard/Bifurcated contact (DC)					Amber				Keep relay	
				1 Form C	2 Form C	3 Form C	4 Form C	4 Form C (twin)	1 Form C	2 Form C	4 Form C	4 Form C (twin)	2 Form C	
Plug-in	1-pole	HC1-socket	HC1-SS-K	●						●				
	2-pole	HC2-socket	HC2-SS-K		●						●			
	3-pole	HC3-socket	HC3-SS-K		●	●					●			
	1/2/4-pole (common)	HC4-socket	HC4-SS-K	●	●		●	●	●	●	●	●	●	●
PC board	1-pole	HC1-socket for PC board	HC1-PS-K	●						●				
	2-pole	HC2-socket for PC board	HC2-PS-K		●						●			
	3-pole	HC3-socket for PC board	HC3-PS-K		●	●					●			
	1/2/4-pole (common)	HC4-socket for PC board	HC4-PS-K	●	●		●	●	●	●	●	●	●	●
Wrapping	1/2/4-pole (common)	HC4-wrapping socket	HC4-WS-K	●	●		●	●	●	●	●	●	●	●
		HC4-wrapping socket (spring)	HC4-WS	●	●		●	●	●	●	●	●	●	●

Notes: 1. Use the retainer that is shipped with the terminal socket.
2. UL/CSA approved type is standard (except for wrapping socket).

HC RELAY TERMINAL SOCKETS

1. Ordinary terminal sockets and terminal sockets for DIN rail assembly are available.
2. In the table below, the terminal socket suitable for each type of HC relay is indicated by a black dot.
3. UL/CSA approval is standard.
4. A hold-down clip is included in the package.



Ordinary terminal socket

The fixing method is the same as for sockets.

HC/HL-LEAF-SPRING-MK



Terminal sockets for DIN rail assembly

The fixing method is the same as for the HC DIN rail terminal sockets and the HL DIN terminal sockets.

HC/HL-LEAF-SPRING-K

TERMINAL SOCKET SELECTOR CHART

Type	No. of pole	Item	Part No.	Packing quantity		Applicable HC relay (Plug-in type)									
						Standard/Bifurcated contact (DC)					Amber				Keep relay
						1 Form C	2 Form C	3 Form C	4 Form C	4 Form C (twin)	1 Form C	2 Form C	4 Form C	4 Form C (twin)	
For DIN rail	2-pole	HC2-slim type DIN terminal socket	HC2-SFD-S	20 pcs.	100 pcs.		●						●		
	2-pole	HC2-DIN	HC2-SFD-K	10 pcs.	100 pcs.		●						●		
	3-pole	HC3-DIN	HC3-SFD-K	5 pcs.	50 pcs.		●	●					●		
	1/2/4-pole (common)	HC4-DIN high terminal socket	HC4-SFD-K	10 pcs.	100 pcs.	●	●		●	●	●	●	●	●	●
	1/2/4-pole (common)	HC3 vertical terminal socket	HC4-TSF-K	20 pcs.	200 pcs.	●	●		●	●	●	●	●	●	●
For general	2-pole	HC2-terminal socket	HC2-SF-K	10 pcs.	100 pcs.		●						●		
	3-pole	HC3-high terminal socket	HC3-HSF-K	5 pcs.	50 pcs.		●	●					●		
	1/2/4-pole (common)	HC-high terminal socket	HC4-HSF-K	5 pcs.	50 pcs.	●	●		●	●	●	●	●	●	

- Notes: 1. Use the retainer that is shipped with the terminal socket.
 2. UL/CSA approved type is standard (except for HC4-TSF-K).
 3. In order to prevent breakage and disfiguring, the screw tightening torque for the terminal socket should be within the range of 0.49 to 0.69 N·m {5 to 7kgf·cm}.

HC RELAY ACCESSORIES

DIMENSIONS (Unit: mm inch)

1. Plug-in type sockets

HC1-Socket (HC1-SS-K)



External dimensions

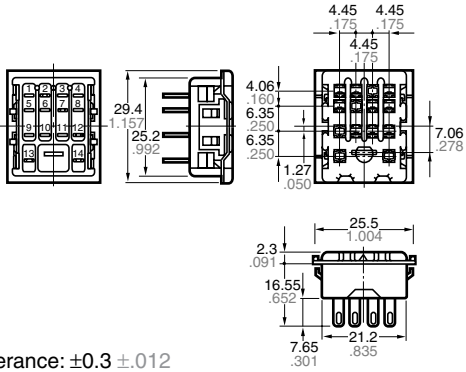

General tolerance: $\pm 0.3 \pm 0.12$

HC2-Socket (HC2-SS-K)

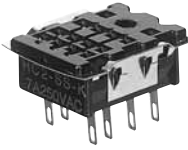

External dimensions

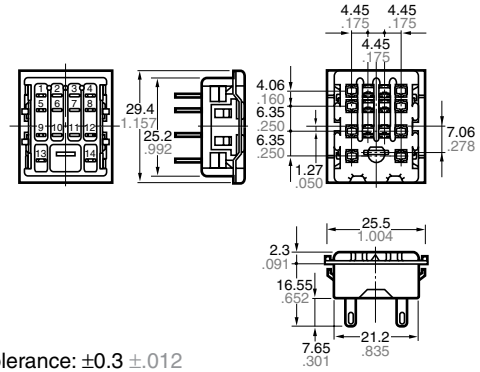

General tolerance: $\pm 0.3 \pm 0.12$

HC3-Socket (HC3-SS-K)



External dimensions

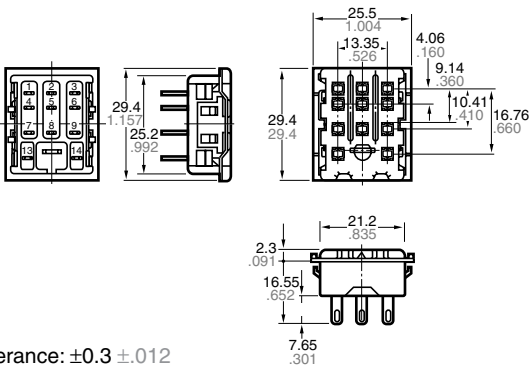

General tolerance: $\pm 0.3 \pm 0.12$

HC4-Socket (HC4-SS-K)

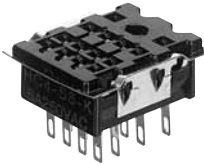

External dimensions

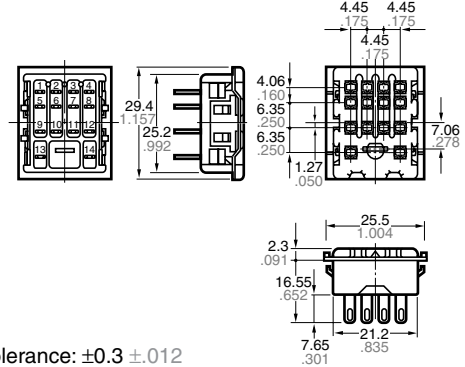

General tolerance: $\pm 0.3 \pm 0.12$

Mounting hole diagram

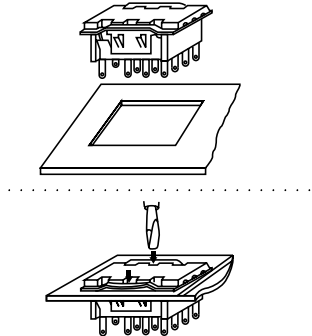

Side-by-side installation

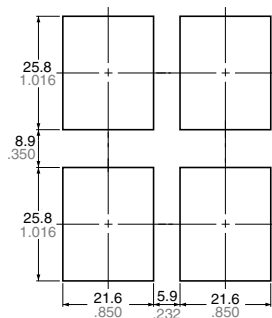

General tolerance: $\pm 0.2 \pm 0.008$

With a relay mounted (HC2-SS-K)



Hold-down clip is packaged with the socket.

- Notes:
1. Applicable chassis board thickness is 1.0 to 2.0 mm.
 2. Installation is easy by inserting the socket from the top into the holes and by depressing the two down arrows on the retention fitting from the front.

HC RELAY ACCESSORIES

2. PC board type sockets

HC1- PC board type socket (HC1-PS-K)



External dimensions

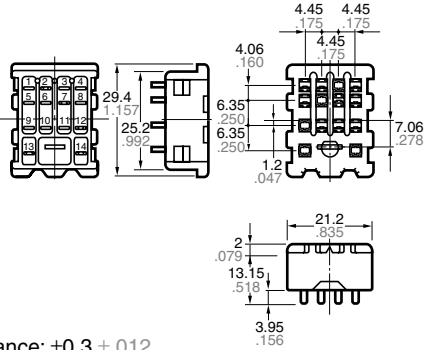

General tolerance: $\pm 0.3 \pm 0.12$

HC2- PC board type socket (HC2-PS-K)



External dimensions

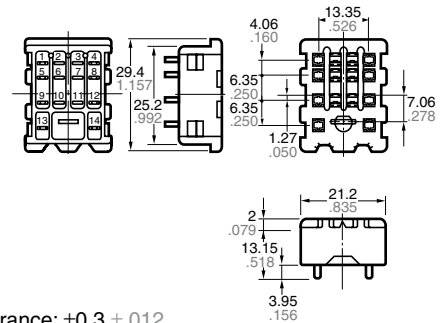

General tolerance: $\pm 0.3 \pm 0.12$

HC3- PC board type socket (HC3-PS-K)



External dimensions

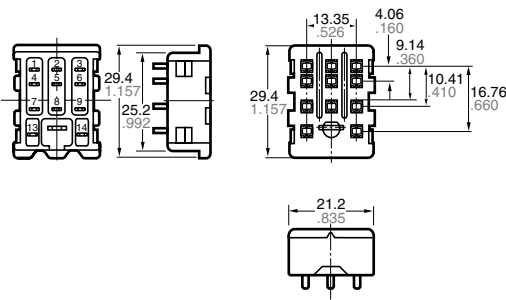

General tolerance: $\pm 0.3 \pm 0.12$

HC4- PC board type socket (HC4-PS-K)



External dimensions

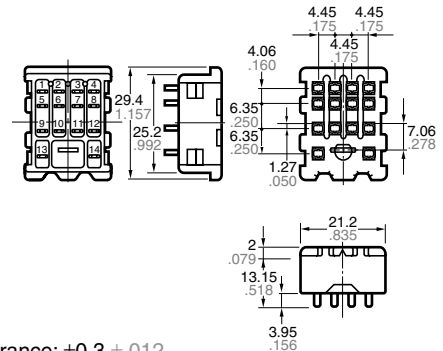

General tolerance: $\pm 0.3 \pm 0.12$

PC board pattern (Bottom view)

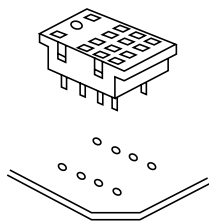

With a relay mounted



Side-by-side installation

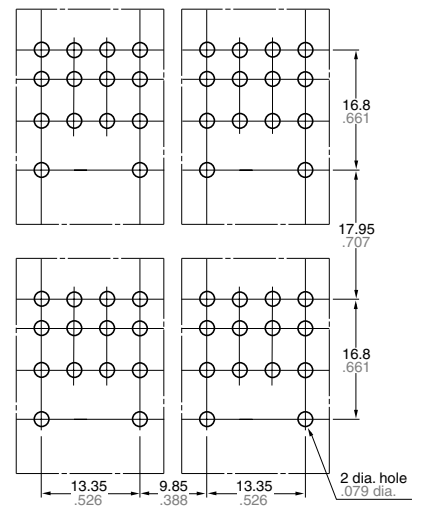

Hold-down clip is packaged with the socket.

1 Form C

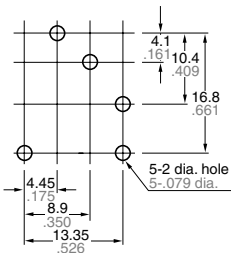

2 Form C

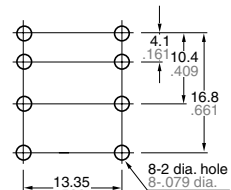

3 Form C

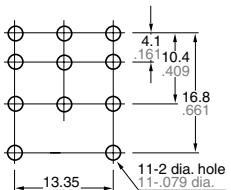

4 Form C

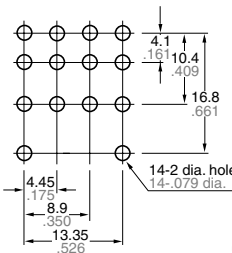

General tolerance: $\pm 0.2 \pm 0.008$

HC RELAY ACCESSORIES

3. Wrapping type sockets

Standard wrapping type sockets
(HC4-WS-K)

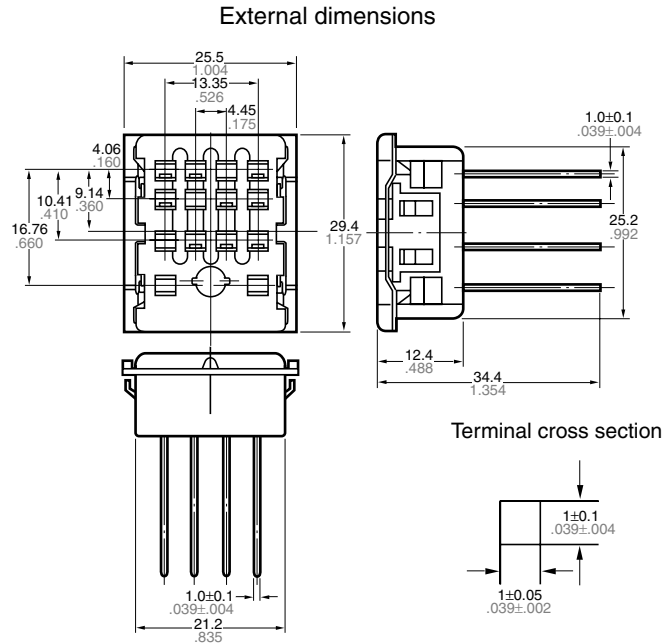
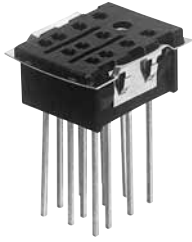

Hold-down clip
(Hold-down clip is packaged with the socket)



General tolerance: $\pm 0.3 \pm 0.12$

Note: The external and mounting dimensions are the same for 1-pole (HC1-WS-K), 2-pole (HC2-WS-K), and 3-pole (HC3-WS-K) types. Only the number of terminals varies.

Wrapping type sockets with hold-down clip
(HC4-WS)

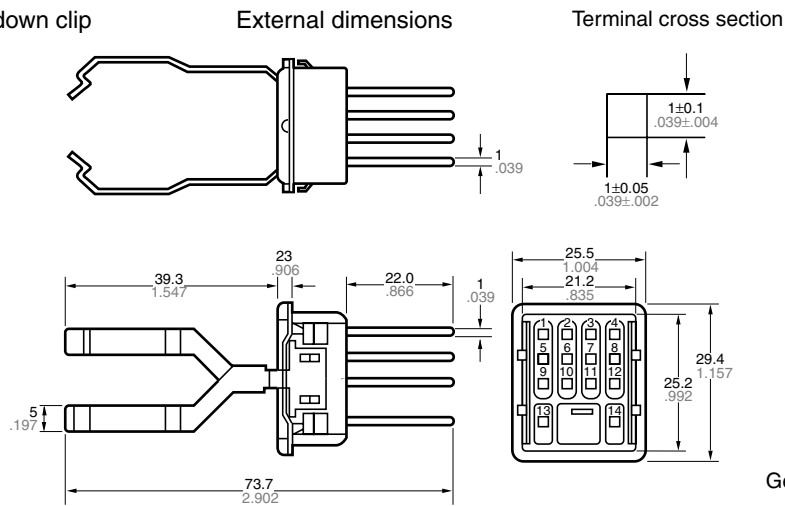
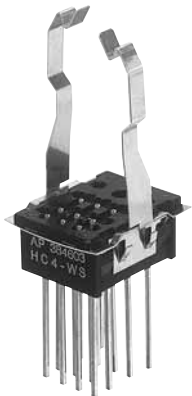

General tolerance: $\pm 0.7 \pm 0.28$

Mounting hole diagram

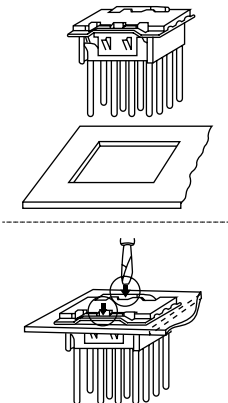

Side-by-side installation

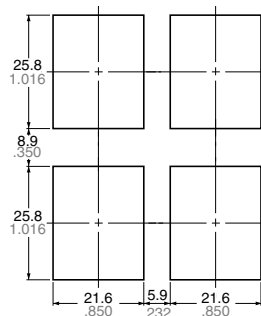

General tolerance: $\pm 0.2 \pm 0.08$

- Notes:
1. Applicable chassis board thickness is 1.0 to 2.0 mm.
 2. Installation is easy by inserting the socket from the top into the holes and by depressing the two down arrows on the retention fitting from the front.

4. Terminal sockets for DIN rail assembly

HC2-Slim type terminal sockets for DIN rail assembly (HC2-SFD-S)

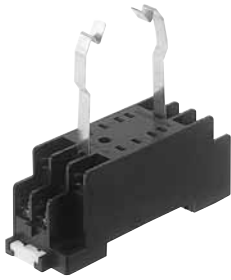

External dimensions

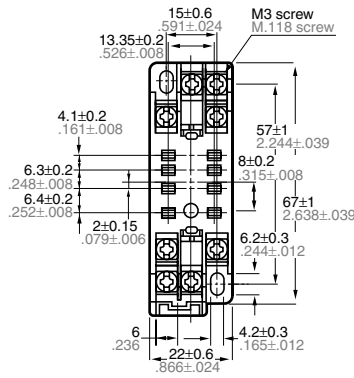

Schematic

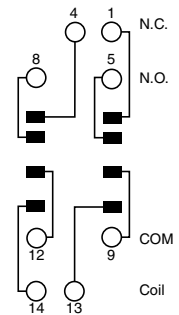

General tolerance: $\pm 0.5 \pm .020$

HC2-high terminal socket for DIN rail assembly (HC2-SFD-K)

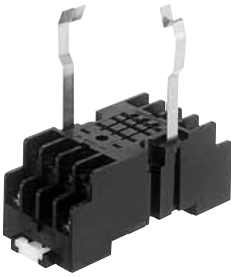

External dimensions

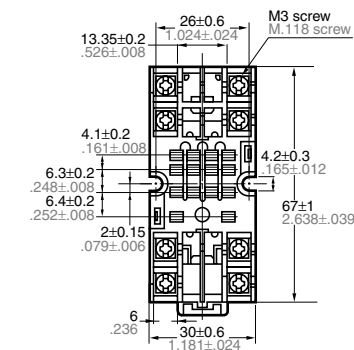

Schematic

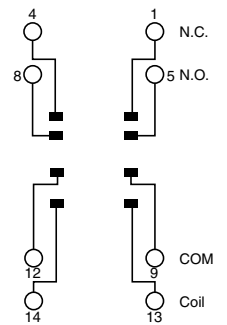

General tolerance: $\pm 0.5 \pm .020$

HC3-high terminal socket for DIN rail assembly (HC3-SFD-K)

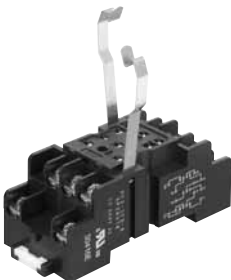

External dimensions

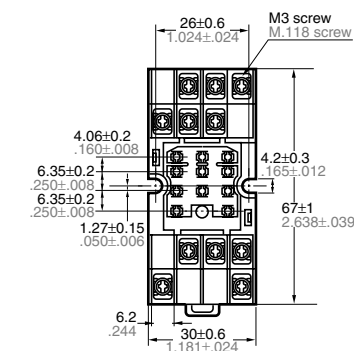

Schematic

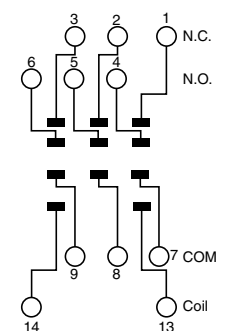

General tolerance: $\pm 0.5 \pm .020$

HC4-high terminal socket for DIN rail assembly (HC4-SFD-K)

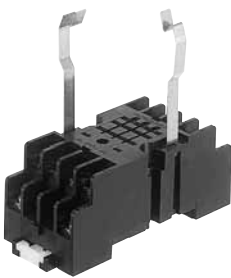

External dimensions

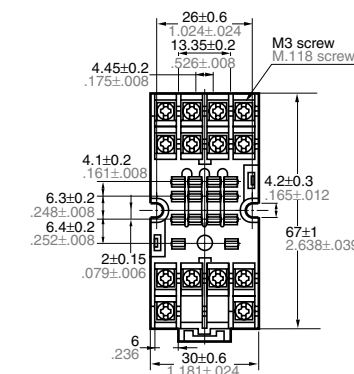

Schematic

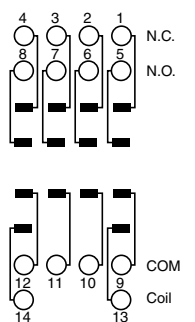

General tolerance: $\pm 0.5 \pm .020$

HC RELAY ACCESSORIES

HC vertical type terminal socket (HC4-TSF-K)

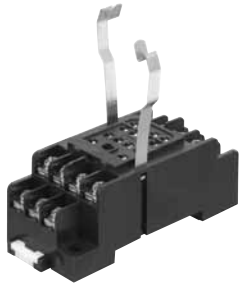

External dimensions

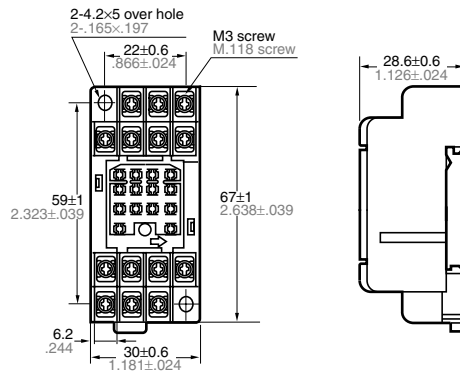

Schematic

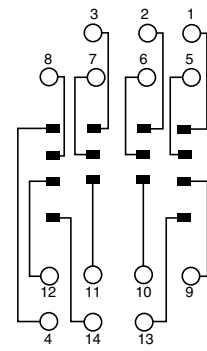

General tolerance: $\pm 0.5 \pm .020$

Mounting hole diagram HC2-Slim type

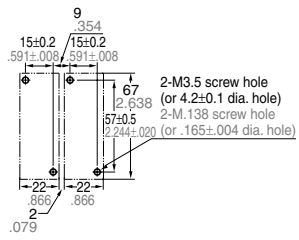

HC2, HC3 and HC4

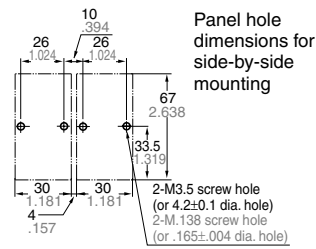

HC vertical type

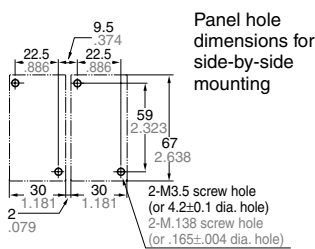

With a relay mounted (HC4-SFD-K)



General tolerance: $\pm 0.1 \pm .004$

Hold-down clip is packaged with the terminal socket.

5. Ordinary terminal sockets

HC2-terminal socket (HC2-SF-K for HC2)



External dimensions

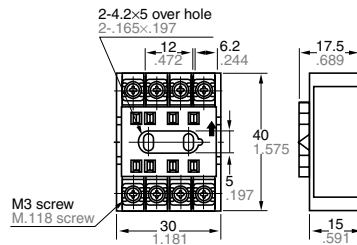

Schematic

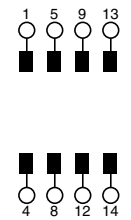

General tolerance: $\pm 0.5 \pm .020$

HC3-high terminal socket (HC3-HSF-K) suitable for both HC2 and HC3



External dimensions

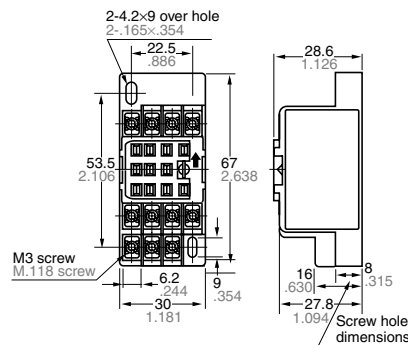

Schematic

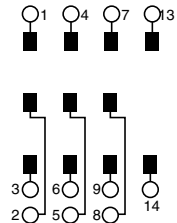

General tolerance: $\pm 0.5 \pm .020$

HC RELAY ACCESSORIES

HC4-high terminal socket (HC4-HSF-K) suitable for HC 1, 2 and 4



External dimensions

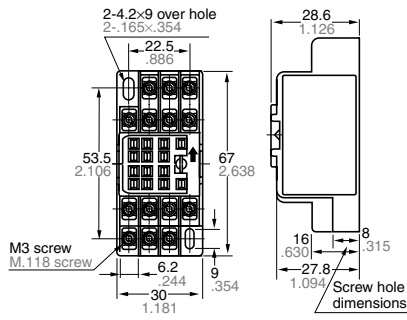

Schematic

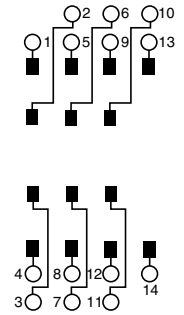

General tolerance: $\pm 0.5 \pm 0.20$

Mounting hole diagram
HC2-SF-K

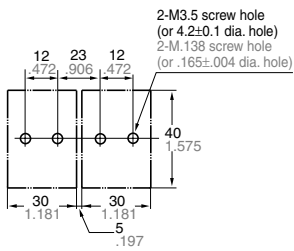

Panel hole dimensions for side-by-side mounting

HC3-HSF-K and HC4-HSF-K

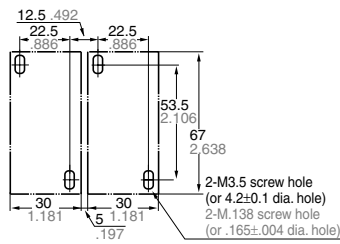

Panel hole dimensions for side-by-side mounting

General tolerance: $\pm 0.1 \pm 0.04$

With a relay mounted (HC2-SF-K)



Hold-down clip is packaged with the terminal socket.

DIMENSIONS (Unit: mm inch)

Mounting rail



ATA48011

Fastening plate



ATA4806

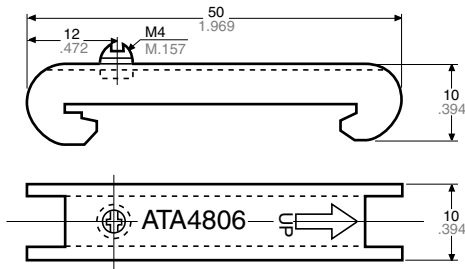
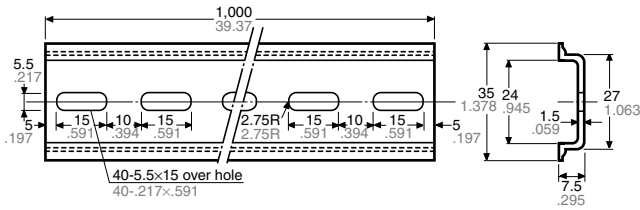

Compliance with RoHS Directive

MOUNTING METHOD

1. DIN terminal socket mounting

1. Enables 'one-touch' attachment to, and easy removal from, mounting rail (35 mm DIN46277 standard rail) on device.

2. By doing away with installation tasks, large cost savings are possible.

3. As well as HC relays, PDX timers, and CDX and CDF time relays can be attached.

Attachment

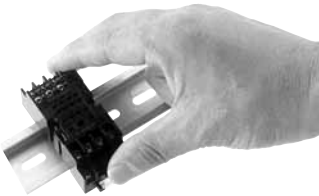

By applying pressure into the rail, secure attachment is possible.

Removal

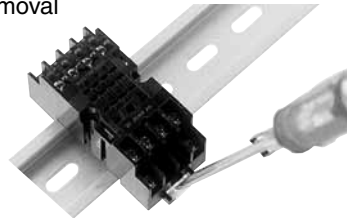

Extraction is easy when a slot head screwdriver or similar tool is used to pull outward the protrusion used for removal.

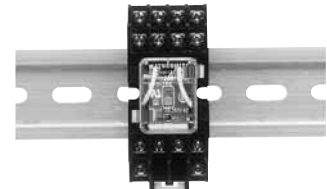

2. Wire-pressed terminals

When using wire-pressed terminals, please use the parts listed below or parts made with similar specifications.

• Applicable wire-pressed terminals

Company name	Type	Part number	
		Fork type	Round type
NICHIFU Co., Ltd.		1.25Y-3N, 1.25Y-3S	1.25-3, 1.25-3S
Nippon Tanshi Co., Ltd.		VR1.25-3, VD1.25-3	1.25-3, 1.25-3TA
J.S.T. Mfg Co., Ltd.		1.25-3X, 1.25-3.7X	R1.25-3, R1.25-M3
Tyco Electronics AMP K.K.		42413-1, 41071-A	42065-1, 60735-1