

Panasonic

ideas for life

New pin layout (LT type) added. Best seller with broad lineup and AC 2000 V breakdown voltage.

TX RELAYS

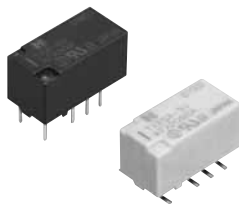

Compliance with RoHS Directive

FEATURES

- 2,000 V breakdown voltage between contact and coil**
The body block construction of the coil that is sealed at formation offers a high breakdown voltage of 2,000 V between contact and coil, and 1,000 V between open contacts.
- Outstanding surge resistance.**
Surge breakdown voltage between open contacts:
1,500 V 10×160μ sec. (FCC part 68)
Surge breakdown voltage between contact and coil:
2,500 V 2×10μ sec. (Bellcore)

- Nominal operating power: High sensitivity of 140mW**
By using the highly efficient polar magnetic circuit "seesaw balance mechanism", a nominal operating power of 140 mW (minimum operating power of 79 mW) has been achieved.
- High contact capacity: 2 A 30 V DC**
- Compact size**
15.0(L) × 7.4(W) × 8.2(H) .591(L) × .291(W) × .323(H)
- The use of gold-clad twin crossbar contacts ensures high contact reliability.**
*We also offer a range of products with AgPd contacts suitable for use in low level load analog circuits (Max. 10V DC 10 mA).
*SX relays designed for low level loads are also available.
- Outstanding vibration and shock resistance.**
Functional shock resistance: 750 m/s²
Destructive shock resistance: 1,000 m/s²
Functional vibration resistance: 10 to 55 Hz (at double amplitude of 3.3 mm .130 inch)

Destructive vibration resistance:
10 to 55 Hz (at double amplitude of 5 mm .197 inch)

- Sealed construction allows automatic washing.**
- A range of surface-mount types is also available**
SA: Low-profile surface-mount terminal type
SL: High connection reliability surface-mount terminal type 
SS: Space saving surface-mount terminal type



TYPICAL APPLICATIONS

- Communications (xDSL, Transmission)
- Measurement
- Security
- Home appliances, and audio/visual equipment
- Automotive equipment
- Medical equipment

ORDERING INFORMATION



Contact arrangement
2: 2 Form C

Surface-mount availability
Nil: Standard PC board terminal type or self-clinching terminal type 
SA: SA type
SL: SL type 
SS: SS type

Operating function
Nil: Single side stable
L: 1 coil latching
L2: 2 coil latching
LT: 2 coil latching

Terminal shape
Nil: Standard PC board terminal or surface-mount terminal
H: Self-clinching terminal 

Nominal coil voltage (DC)*
1.5, 3, 4.5, 5, 6, 9, 12, 24, 48V

Contact material
Nil: Standard contact (Ag+Au clad)
1: AgPd contact (low level load); AgPd+Au clad (stationary), AgPd (movable)

Packing style
Nil: Tube packing
X: Tape and reel (picked from 1/3/4/5-pin side)
Z: Tape and reel packing (picked from the 8/9/10/12-pin side)

Notes: 1. *48 V coil type: Single side stable only
2. In case of 5 V transistor drive circuit, it is recommended to use 4.5 V type relay.



TYPES

1. Standard PC board terminal

| Contact arrangement | Nominal coil voltage | Single side stable | 1 coil latching | 2 coil latching (L2) | 2 coil latching (LT) |
|---------------------|----------------------|--------------------|-----------------|----------------------|----------------------|
| | | Part No. | Part No. | Part No. | Part No. |
| 2 Form C | 1.5V DC | TX2-1.5V | TX2-L-1.5V | TX2-L2-1.5V | TX2-LT-1.5V |
| | 3V DC | TX2-3V | TX2-L-3V | TX2-L2-3V | TX2-LT-3V |
| | 4.5V DC | TX2-4.5V | TX2-L-4.5V | TX2-L2-4.5V | TX2-LT-4.5V |
| | 5V DC | TX2-5V | TX2-L-5V | TX2-L2-5V | TX2-LT-5V |
| | 6V DC | TX2-6V | TX2-L-6V | TX2-L2-6V | TX2-LT-6V |
| | 9V DC | TX2-9V | TX2-L-9V | TX2-L2-9V | TX2-LT-9V |
| | 12V DC | TX2-12V | TX2-L-12V | TX2-L2-12V | TX2-LT-12V |
| | 24V DC | TX2-24V | TX2-L-24V | TX2-L2-24V | TX2-LT-24V |
| | 48V DC | TX2-48V | — | — | — |

Standard packing: Tube: 40 pcs.; Case: 1,000 pcs.

Note: Please add "-1" to the end of the part number for AgPd contacts (low level load).

2. self-clinching terminal

| Contact arrangement | Nominal coil voltage | Single side stable | 1 coil latching | 2 coil latching (L2) | 2 coil latching (LT) |
|---------------------|----------------------|--------------------|-----------------|----------------------|----------------------|
| | | Part No. | Part No. | Part No. | Part No. |
| 2 Form C | 1.5V DC | TX2-H-1.5V | TX2-L-H-1.5V | TX2-L2-H-1.5V | TX2-LT-H-1.5V |
| | 3V DC | TX2-H-3V | TX2-L-H-3V | TX2-L2-H-3V | TX2-LT-H-3V |
| | 4.5V DC | TX2-H-4.5V | TX2-L-H-4.5V | TX2-L2-H-4.5V | TX2-LT-H-4.5V |
| | 5V DC | TX2-H-5V | TX2-L-H-5V | TX2-L2-H-5V | TX2-LT-H-5V |
| | 6V DC | TX2-H-6V | TX2-L-H-6V | TX2-L2-H-6V | TX2-LT-H-6V |
| | 9V DC | TX2-H-9V | TX2-L-H-9V | TX2-L2-H-9V | TX2-LT-H-9V |
| | 12V DC | TX2-H-12V | TX2-L-H-12V | TX2-L2-H-12V | TX2-LT-H-12V |
| | 24V DC | TX2-H-24V | TX2-L-H-24V | TX2-L2-H-24V | TX2-LT-H-24V |
| | 48V DC | TX2-H-48V | — | — | — |

Standard packing: Tube: 40 pcs.; Case: 1,000 pcs.

Note: Please add "-1" to the end of the part number for AgPd contacts (low level load).

3. Surface-mount terminal

1) Tube packing

| Contact arrangement | Nominal coil voltage | Single side stable | 1 coil latching | 2 coil latching (L2) | 2 coil latching (LT) |
|---------------------|----------------------|--------------------|-----------------|----------------------|----------------------|
| | | Part No. | Part No. | Part No. | Part No. |
| 2c | 1.5V DC | TX2S□-1.5V | TX2S□-L-1.5V | TX2S□-L2-1.5V | TX2S□-LT-1.5V |
| | 3V DC | TX2S□-3V | TX2S□-L-3V | TX2S□-L2-3V | TX2S□-LT-3V |
| | 4.5V DC | TX2S□-4.5V | TX2S□-L-4.5V | TX2S□-L2-4.5V | TX2S□-LT-4.5V |
| | 5V DC | TX2S□-5V | TX2S□-L-5V | TX2S□-L2-5V | TX2S□-LT-5V |
| | 6V DC | TX2S□-6V | TX2S□-L-6V | TX2S□-L2-6V | TX2S□-LT-6V |
| | 9V DC | TX2S□-9V | TX2S□-L-9V | TX2S□-L2-9V | TX2S□-LT-9V |
| | 12V DC | TX2S□-12V | TX2S□-L-12V | TX2S□-L2-12V | TX2S□-LT-12V |
| | 24V DC | TX2S□-24V | TX2S□-L-24V | TX2S□-L2-24V | TX2S□-LT-24V |
| | | 48V DC | TX2S□-48V | — | — |

□: For each surface-mounted terminal identification, input the following letter. SA type: A, SL type: L, SS type: S

Standard packing: Tube: 40 pcs.; Case: 1,000 pcs.

Note: Please add "-1" to the end of the part number for AgPd contacts (low level load).

2) Tape and reel packing

| Contact arrangement | Nominal coil voltage | Single side stable | 1 coil latching | 2 coil latching (L2) | 2 coil latching (LT) |
|---------------------|----------------------|--------------------|-----------------|----------------------|----------------------|
| | | Part No. | Part No. | Part No. | Part No. |
| 2 Form C | 1.5V DC | TX2S□-1.5V-Z | TX2S□-L-1.5V-Z | TX2S□-L2-1.5V-Z | TX2S□-LT-1.5V-Z |
| | 3V DC | TX2S□-3V-Z | TX2S□-L-3V-Z | TX2S□-L2-3V-Z | TX2S□-LT-3V-Z |
| | 4.5V DC | TX2S□-4.5V-Z | TX2S□-L-4.5V-Z | TX2S□-L2-4.5V-Z | TX2S□-LT-4.5V-Z |
| | 5V DC | TX2S□-5V-Z | TX2S□-L-5V-Z | TX2S□-L2-5V-Z | TX2S□-LT-5V-Z |
| | 6V DC | TX2S□-6V-Z | TX2S□-L-6V-Z | TX2S□-L2-6V-Z | TX2S□-LT-6V-Z |
| | 9V DC | TX2S□-9V-Z | TX2S□-L-9V-Z | TX2S□-L2-9V-Z | TX2S□-LT-9V-Z |
| | 12V DC | TX2S□-12V-Z | TX2S□-L-12V-Z | TX2S□-L2-12V-Z | TX2S□-LT-12V-Z |
| | 24V DC | TX2S□-24V-Z | TX2S□-L-24V-Z | TX2S□-L2-24V-Z | TX2S□-LT-24V-Z |
| | 48V DC | TX2S□-48V-Z | — | — | — |

Standard packing: Tape and reel: 500 pcs.; Case: 1,000 pcs.

Notes: 1. Tape and reel packing symbol "-Z" is not marked on the relay. "X" type tape and reel packing (picked from 1/2/3/4-pin side) is also available.

2. Please add "-1" to the end of the part number for AgPd contacts (low level load).

**RATING****1. Coil data**

1) Single side stable

| Nominal coil voltage | Pick-up voltage (at 20°C 68°F) | Drop-out voltage (at 20°C 68°F) | Nominal operating current [±10%] (at 20°C 68°F) | Coil resistance [±10%] (at 20°C 68°F) | Nominal operating power | Max. applied voltage (at 20°C 68°F) |
|----------------------|--|--|---|---------------------------------------|-------------------------|-------------------------------------|
| 1.5V DC | 75%V or less of nominal voltage* (Initial) | 10%V or more of nominal voltage* (Initial) | 93.8mA | 16Ω | 140mW | 150%V of nominal voltage |
| 3V DC | | | 46.7mA | 64.3Ω | | |
| 4.5V DC | | | 31mA | 145Ω | | |
| 5V DC | | | 28.1mA | 178Ω | | |
| 6V DC | | | 23.3mA | 257Ω | | |
| 9V DC | | | 15.5mA | 579Ω | | |
| 12V DC | | | 11.7mA | 1,028Ω | | |
| 24V DC | | | 5.8mA | 4,114Ω | | |
| 48V DC | | | 5.6mA | 8,533Ω | 270mW | |

2) 1 coil latching

| Nominal coil voltage | Set voltage (at 20°C 68°F) | Reset voltage (at 20°C 68°F) | Nominal operating current [±10%] (at 20°C 68°F) | Coil resistance [±10%] (at 20°C 68°F) | Nominal operating power | Max. applied voltage (at 20°C 68°F) |
|----------------------|--|--|---|---------------------------------------|-------------------------|-------------------------------------|
| 1.5V DC | 75%V or less of nominal voltage* (Initial) | 75%V or less of nominal voltage* (Initial) | 66.7mA | 22.5Ω | 100mW | 150%V of nominal voltage |
| 3V DC | | | 33.3mA | 90Ω | | |
| 4.5V DC | | | 22.2mA | 202.5Ω | | |
| 5V DC | | | 20mA | 250Ω | | |
| 6V DC | | | 16.7mA | 360Ω | | |
| 9V DC | | | 11.1mA | 810Ω | | |
| 12V DC | | | 8.3mA | 1,440Ω | | |
| 24V DC | | | 4.2mA | 5,760Ω | | |

3) 2 coil latching (L2, LT)

| Nominal coil voltage | Set voltage (at 20°C 68°F) | Reset voltage (at 20°C 68°F) | Nominal operating current [±10%] (at 20°C 68°F) | | Coil resistance [±10%] (at 20°C 68°F) | | Nominal operating power | | Max. applied voltage (at 20°C 68°F) |
|----------------------|--|--|---|------------|---------------------------------------|------------|-------------------------|------------|-------------------------------------|
| | | | Set coil | Reset coil | Set coil | Reset coil | Set coil | Reset coil | |
| 1.5V DC | 75%V or less of nominal voltage* (Initial) | 75%V or less of nominal voltage* (Initial) | 133.9mA | 133.9mA | 11.2Ω | 11.2Ω | 200mW | 200mW | 150%V of nominal voltage |
| 3V DC | | | 66.7mA | 66.7mA | 45Ω | 45Ω | | | |
| 4.5V DC | | | 44.5mA | 44.5mA | 101.2Ω | 101.2Ω | | | |
| 5V DC | | | 40mA | 40mA | 125Ω | 125Ω | | | |
| 6V DC | | | 33.3mA | 33.3mA | 180Ω | 180Ω | | | |
| 9V DC | | | 22.2mA | 22.2mA | 405Ω | 405Ω | | | |
| 12V DC | | | 16.7mA | 16.7mA | 720Ω | 720Ω | | | |
| 24V DC | | | 8.3mA | 8.3mA | 2,880Ω | 2,880Ω | | | |

*Pulse drive (JIS C 5442-1986)



2. Specifications

| Characteristics | Item | Specifications | |
|--|--|--|---|
| Contact | Arrangement | 2 Form C | |
| | Initial contact resistance, max. | Max. 100 mΩ (By voltage drop 6 V DC 1A) | |
| | Contact material | Standard contact: Ag+Au clad, AgPd contact (low level load): AgPd+Au clad (stationary), AgPd (movable) | |
| Rating | Nominal switching capacity | Standard contact: 2 A 30 V DC, AgPd contact: 1 A 30 V DC (resistive load) | |
| | Max. switching power | Standard contact: 60 W (DC), AgPd contact: 30 W (DC) (resistive load) | |
| | Max. switching voltage | 220V DC | |
| | Max. switching current | Standard contact: 2 A, AgPd contact: 1 A | |
| | Min. switching capacity (Reference value)*1 | 10μA 10mV DC | |
| | Nominal operating power | Single side stable | 140 mW (1.5 to 24 V DC), 270 mW (48 V DC) |
| | | 1 coil latching | 100 mW (1.5 to 24 V DC) |
| 2 coil latching | | 200 mW (1.5 to 24 V DC) | |
| Electrical characteristics | Insulation resistance (Initial) | Min. 1,000MΩ (at 500V DC) Measurement at same location as "Initial breakdown voltage" section. | |
| | Breakdown voltage (Initial) | Between open contacts | 1,000 Vrms for 1min. (Detection current: 10mA) |
| | | Between contact and coil | 2,000 Vrms for 1min. (Detection current: 10mA) |
| | | Between contact sets | 1,000 Vrms for 1min. (Detection current: 10mA) |
| | Surge breakdown voltage (Initial) | Between open contacts | 1,500 V (10×160μs) (FCC Part 68) |
| | | Between contacts and coil | 2,500 V (2×10μs) (Telcordia) |
| | Temperature rise (at 20°C 68°F) | Max. 50°C (By resistive method, nominal coil voltage applied to the coil; contact carrying current: 2A.) | |
| | Operate time [Set time] (at 20°C 68°F) | Max. 4 ms [Max. 4 ms] (Nominal coil voltage applied to the coil, excluding contact bounce time.) | |
| Release time [Reset time] (at 20°C 68°F) | Max. 4 ms [Max. 4 ms] (Nominal coil voltage applied to the coil, excluding contact bounce time.) (without diode) | | |
| Mechanical characteristics | Shock resistance | Functional | Min. 750 m/s ² (Half-wave pulse of sine wave: 6 ms; detection time: 10μs.) |
| | | Destructive | Min. 1,000 m/s ² (Half-wave pulse of sine wave: 6 ms.) |
| | Vibration resistance | Functional | 10 to 55 Hz at double amplitude of 3.3 mm (Detection time: 10μs.) |
| | | Destructive | 10 to 55 Hz at double amplitude of 5 mm |
| Expected life | Mechanical | Min. 10 ⁸ (at 180 cpm) | |
| | Electrical | Min. 10 ⁵ (2 A 30 V DC resistive), 5×10 ⁵ (1 A 30 V DC resistive) (at 20 cpm) | |
| Conditions | Conditions for operation, transport and storage*2 | Ambient temperature: -40°C to +85°C (up to 24 V coil) -40°F to +185°F (up to 24 V coil) [-40°C to +70°C (48 V coil) -40°F to +158°F (48 V coil)]; Humidity: 5 to 85% R.H. (Not freezing and condensing at low temperature) | |
| | Max. operating speed (at rated load) | 20 cpm | |
| Unit weight | | Approx. 2 g .071 oz | |

Notes: *1 This value can change due to the switching frequency, environmental conditions, and desired reliability level, therefore it is recommended to check this with the actual load. (AgPd contact type is available for low level load switching [10V DC, 10mA max. level])
*2 Refer to 6. Conditions for operation, transport and storage mentioned in AMBIENT ENVIRONMENT.

REFERENCE DATA

1. Maximum switching capacity

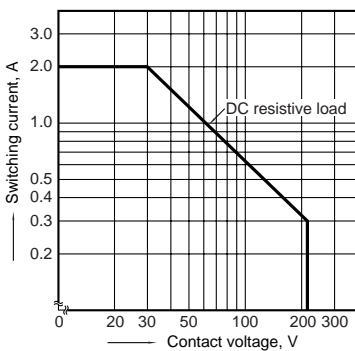

2. Life curve

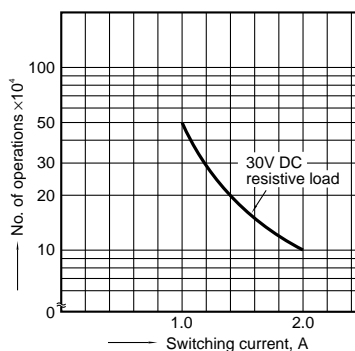

3. Mechanical life

Tested sample: TX2-5V, 10 pcs.
Operating speed: 180 cpm

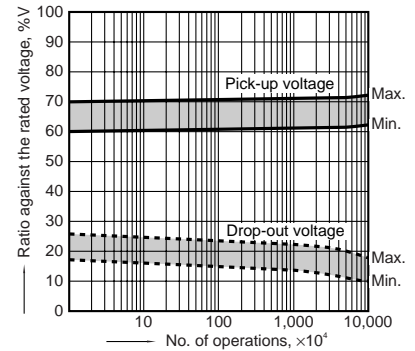

4. Electrical life (2A 30V DC resistive load)

Tested sample: TX2-5V, 6 pcs.
Operating speed: 20 cpm

Change of pick-up and drop-out voltage

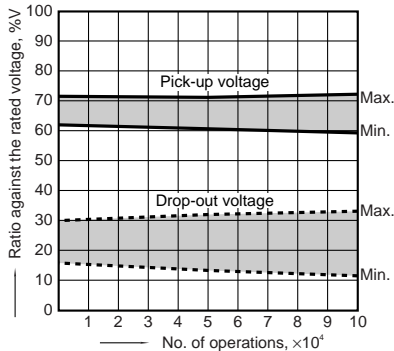

Change of contact resistance

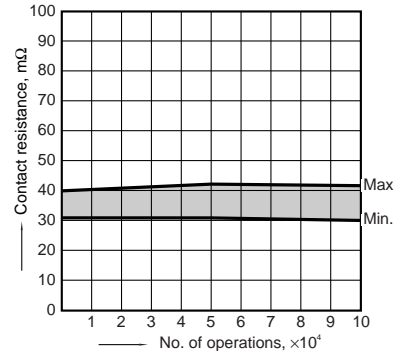

5-(1). Coil temperature rise

Tested sample: TX2-5V, 6 pcs.
Point measured: Inside the coil
Ambient temperature: 25°C 77°F, 85°C 185°F

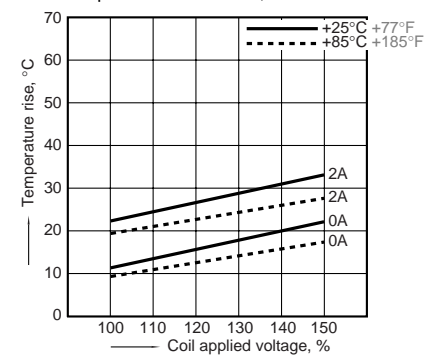



5-(2). Coil temperature rise

Tested sample: TX2-48V, 6 pcs.
Point measured: Inside the coil
Ambient temperature: 25°C 77°F, 70°C 158°F

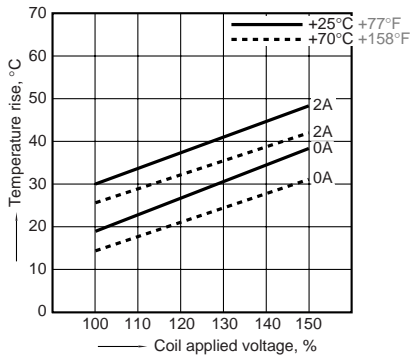

6-(1). Operate and release time (with diode)

Tested sample: TX2-5V, 10 pcs.

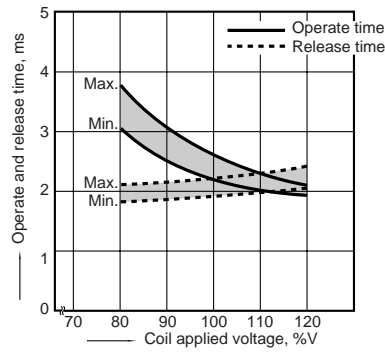

6-(2). Operate and release time (without diode)

Tested sample: TX2-5V, 10 pcs.

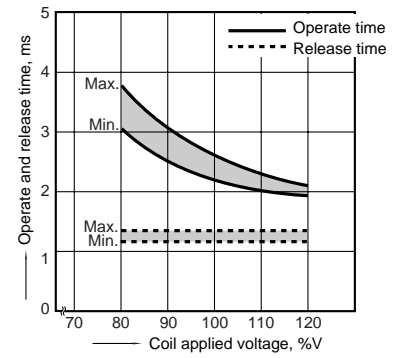

7. Ambient temperature characteristics

Tested sample: TX2-5V, 5 pcs.

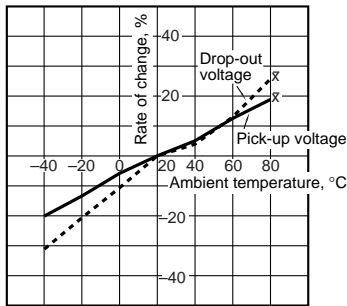

8-(1). High frequency characteristics (Isolation)

Tested sample: TX2-12V, 2 pcs.

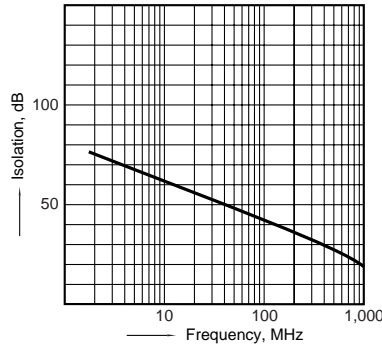

8-(2). High frequency characteristics (Insertion loss)

Tested sample: TX2-12V, 2 pcs.

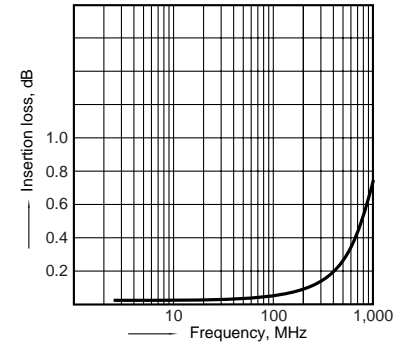

9 Malfunctional shock (single side stable)

Tested sample: TX2-5V, 6 pcs.

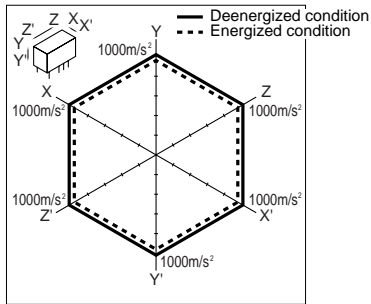

10-(1). Influence of adjacent mounting

Tested sample: TX2-12V, 6 pcs.

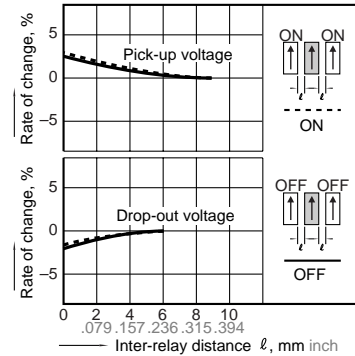

10-(2). Influence of adjacent mounting

Tested sample: TX2-12V, 6 pcs.

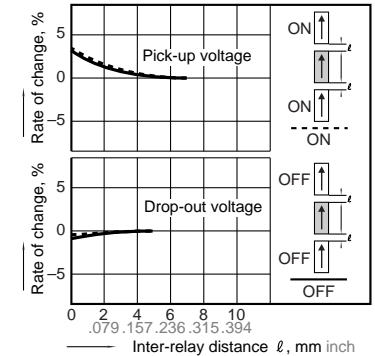

11. Pulse dialing test

Tested sample: TX2-5V, 6 pcs.
(35 mA 48 V DC wire spring relay load)

Circuit

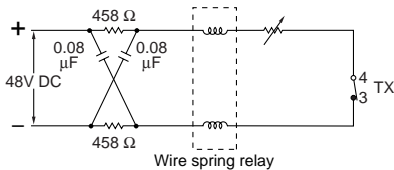

Change of pick-up and drop-out voltage

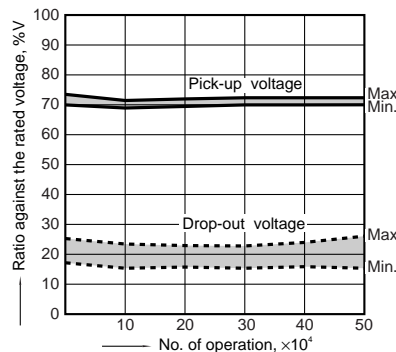

Change of contact resistance

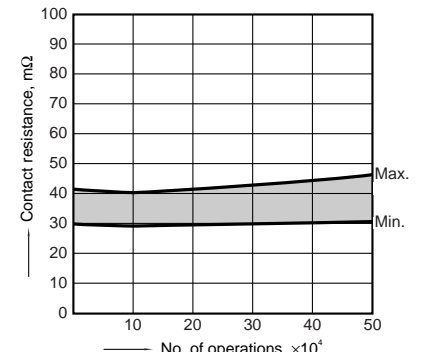

Note: Data of surface-mount type are the same as those of PC board terminal type.



DIMENSIONS (mm inch)

The CAD data of the products with a **CAD Data** mark can be downloaded from: <http://panasonic-electric-works.net/ac>

1. Standard PC board terminal and Self clinching terminal

CAD Data



Single side stable and 1 coil latching type
External dimensions
Standard PC board terminal

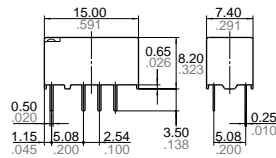

2 coil latching type (L2, LT)
External dimensions
Standard PC board terminal

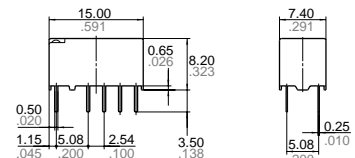

Self clinching terminal

General tolerance: $\pm 0.3 \pm 0.12$

Self clinching terminal

General tolerance: $\pm 0.3 \pm 0.12$

PC board pattern (Bottom view)

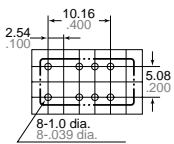

Schematic (Bottom view)
Single side stable

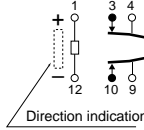

1 coil latching

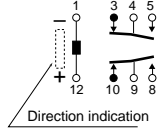

PC board pattern (Bottom view)

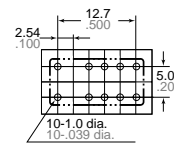

Schematic (Bottom view)
2 coil latching (L2)

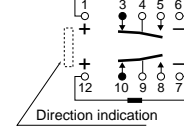

2 coil latching (LT)

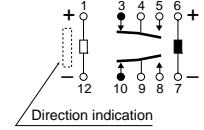

Tolerance: $\pm 0.1 \pm 0.04$

(Deenergized condition)

(Reset condition)

Tolerance: $\pm 0.1 \pm 0.04$

(Reset condition)

(Reset condition)

2. Surface-mount terminal

CAD Data



| Type | External dimensions (General tolerance: $\pm 0.3 \pm 0.12$) | | Suggested mounting pad (Top view) (Tolerance: $\pm 0.1 \pm 0.04$) | |
|---------|--|-------------------------------|--|-------------------------------|
| | Single side stable and 1 coil latching type | 2 coil latching type (L2, LT) | Single side stable and 1 coil latching type | 2 coil latching type (L2, LT) |
| SA type | | | | |
| SL type | | | | |
| SS type | | | | |

Schematic (Top view)

Single side stable

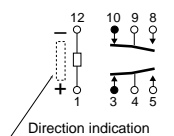

(Deenergized condition)

1 coil latching

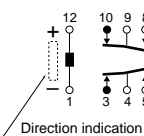

(Reset condition)

2 coil latching (L2)

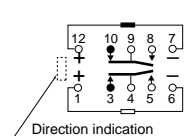

(Reset condition)

2 coil latching (LT)

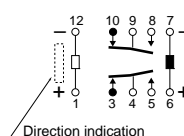

(Reset condition)



NOTES

1. Packing style

1) The relay is packed in a tube with the relay orientation mark on the left side, as shown in the figure below.

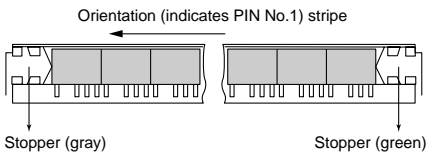

2) Tape and reel packing (surface-mount terminal type)

- (1) Tape dimensions
- (i) SA type

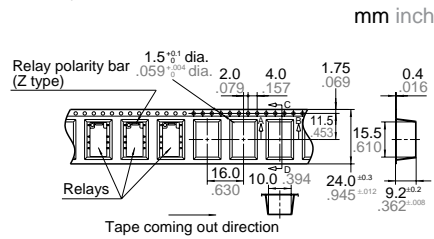

2. Automatic insertion

To maintain the internal function of the relay, the chucking pressure should not exceed the values below.

- Chucking pressure in the direction A: 4.9 N {500gf} or less
- Chucking pressure in the direction B: 9.8 N {1 kgf} or less
- Chucking pressure in the direction C: 9.8 N {1 kgf} or less

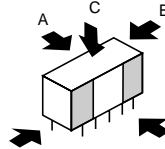

Please chuck the portion.
Avoid chucking the center of the relay.
In addition, excessive chucking pressure to the pinpoint of the relay should be avoided.

(ii) SL type

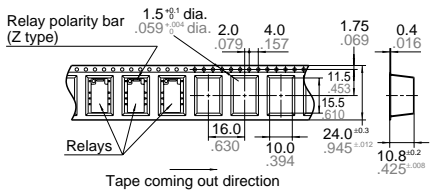

For general cautions for use, please refer to the "Cautions for use of Signal Relays" or "General Application Guidelines".

(iii) SS type

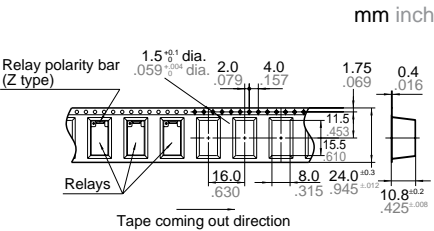

(2) Dimensions of plastic reel

