



Compact DIP type SSR
Ideal for AC load control

AQ-H RELAYS

FEATURES

1. Supports 0.3 A, 0.6 A, 0.9 A and 1.2 A ON-state RMS currents.
2. The 1.2 A type saves space with a DIP 8-pin package.

4. High dielectric strength: 5,000 V AC (between input and output)
5. Two types available: Zero-cross type and Random type

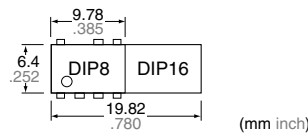
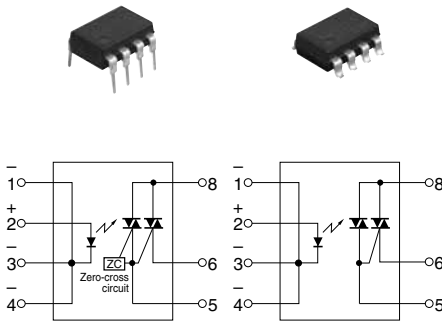

3. Handles both 100 and 200 V AC loads

This relay handles both voltages in a single product. It is not necessary for users that use both types to manage separate part numbers.

TYPICAL APPLICATIONS

1. Home appliances (air conditioner, microwave oven, washing machine, personal hygiene system, refrigerator, fan heater, inductive heating cooker, rice cooker and humidifier, etc.)
2. Industrial equipment

RoHS compliant

TYPES

Type	Output rating*		Type	Part No.				Packing quantity	
				Through hole terminal	Surface-mount terminal				
	Repetitive peak OFF-state voltage	ON-state RMS current			Tube packing style	Tube packing style	Tape and reel packing style		Tube
AC type	600 V	0.3 A	Zero-cross	AQH0213	AQH0213A	AQH0213AX	AQH0213AZ	1 tube contains 50 pcs. 1 batch contains 500 pcs.	
				AQH1213	AQH1213A	AQH1213AX	AQH1213AZ		
				AQH2213	AQH2213A	AQH2213AX	AQH2213AZ		
				AQH3213	AQH3213A	AQH3213AX	AQH3213AZ		
		0.6 A	Random	AQH0223	AQH0223A	AQH0223AX	AQH0223AZ		
				AQH1223	AQH1223A	AQH1223AX	AQH1223AZ		
				AQH2223	AQH2223A	AQH2223AX	AQH2223AZ		
				AQH3223	AQH3223A	AQH3223AX	AQH3223AZ		
				AQH0223	AQH0223A	AQH0223AX	AQH0223AZ		
				AQH1223	AQH1223A	AQH1223AX	AQH1223AZ		

* Indicate the repetitive peak OFF-state voltage and ON-state RMS current: peak AC.
Note: For space reasons, the SMD terminal shape indicator "A" and the package type indicator "X" and "Z" are omitted from the seal.

RATING

1. Absolute maximum ratings (Ambient temperature: 25°C 77°F)

Item	Symbol	AQH0213, AQH0223	AQH1213, AQH1223	AQH2213, AQH2223	AQH3213, AQH3223	Remarks
Input	LED forward current	50 mA				
	LED reverse voltage	6 V				
	Peak forward current	1 A				f = 100 Hz, Duty Ratio = 0.1%
Output	Repetitive peak OFF-state voltage	600 V				
	ON-state RMS current	0.3 A	0.6 A	0.9 A	1.2 A	
	Non-repetitive surge current	3 A	6 A	9 A	12 A	60Hz, 1 cycle
I/O isolation voltage	V_{iso}	5,000 V AC				
Operating temperature	T_{opr}	-30°C to +85°C -22°F to +185°F				Non-condensing at low temperatures
Storage temperature	T_{stg}	-40°C to +125°C -40°F to +257°F				

Note: "A", "AX" and "AZ" at the end of the part numbers have been omitted.

2. Characteristics (Ambient temperature: 25°C 77°F)

Item		Symbol	AQH0213, AQH1213, AQH2213, AQH3213	AQH0223, AQH1223, AQH2223, AQH3223	Remarks
Input	LED dropout voltage	Typical	1.21 V		I _F = 20 mA
		Maximum	1.3 V		
	LED reverse current	Typical	—		V _R = 6 V
		Maximum	10 μA		
	Peak OFF-state current	Typical	—		I _F = 0 mA V _{DRM} = 600 V
		Maximum	100 μA		
Output	Peak ON-state voltage	Typical	—		I _F = 10 mA I _{TM} = Max.
		Maximum	2.5 V		
	Holding current	Typical	—		
		Maximum	25 mA		
	Critical rate of rise of OFF-state voltage	Minimum	200 V/μs		V _{DRM} = 600 V × 1/√2
Transfer characteristics	Trigger LED current	Maximum	10 mA		V _O = 6 V R _L = 100 Ω
	Zero-cross voltage	Maximum	50 V		I _F = 10 mA
	Turn on time*	Maximum	100 μs		I _F = 20 mA V _O = 6 V R _L = 100 Ω
	I/O isolation resistance	Minimum	50 GΩ		500 V DC

Notes: 1. For type of connection, see page 4.
2. "A", "AX" and "AZ" at the end of the part numbers have been omitted.

*Turn on time

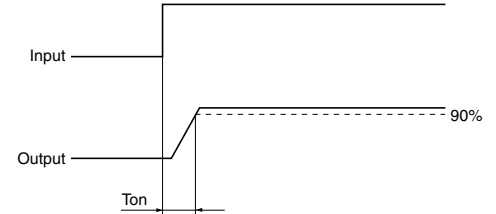

RECOMMENDED OPERATING CONDITIONS

Please follow the conditions below in order to ensure accurate operation and release of the phototriac coupler.

Item	Symbol	Value	Unit
Input LED current	I _F	20	mA

REFERENCE DATA

1. ON-state RMS current vs. Ambient temperature characteristics

Allowable ambient temperature: -30°C to +85°C -22°F to +185°F

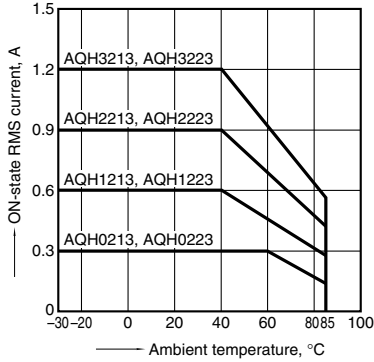

2. Peak ON-state voltage vs. Ambient temperature characteristics

LED current: 10 mA; ON current: Max. Measured portion: between terminals 6 and 8

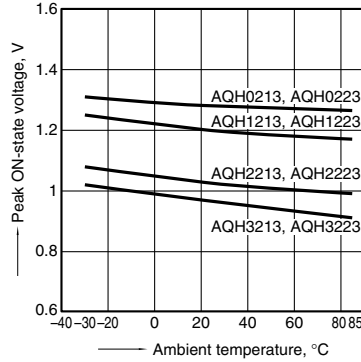

3. Trigger LED current vs. Ambient temperature characteristics

Load voltage: 6 V DC; Load resistance: 100Ω

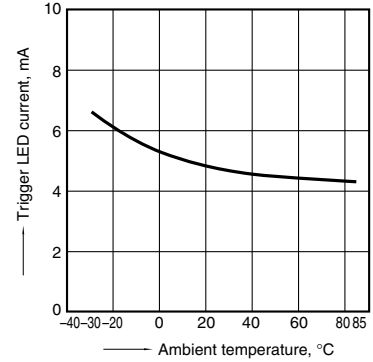

4. LED dropout voltage vs. Ambient temperature characteristics

LED current: 10 to 50 mA

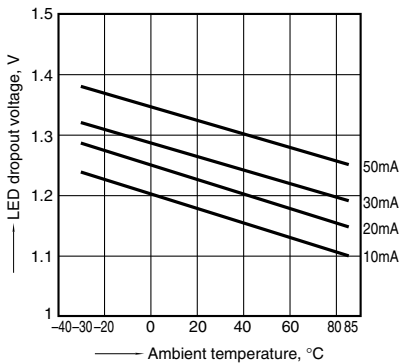

5. Turn on time vs. LED current characteristics

Load voltage: 6 V DC; Load resistance: 100Ω Measured portion: between terminals 6 and 8

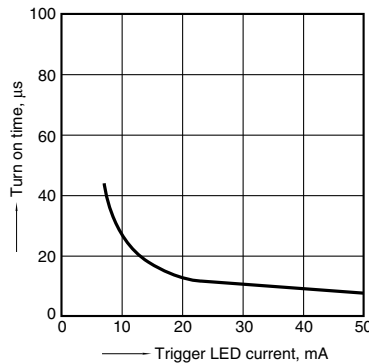

6. Repetitive peak OFF-state current vs. Load voltage characteristics

Ambient temperature: 25°C 77°F; Measured portion: between terminals 6 and 8; LED current: 0 mA

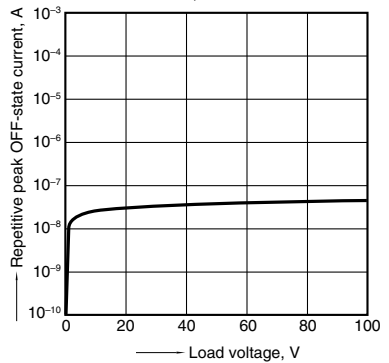

7. Hold current vs. Ambient temperature characteristics

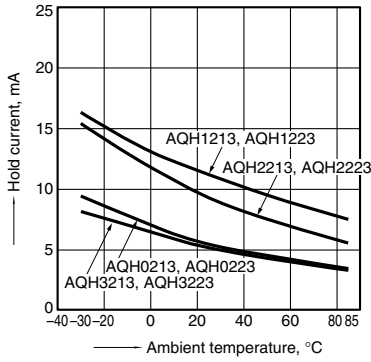

8. Zero-cross voltage vs. Ambient temperature characteristics

LED current: 10 mA

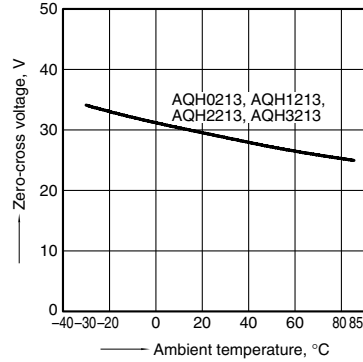

DIMENSIONS (mm inch)

The CAD data of the products with a **CAD Data** mark can be downloaded from: <http://industrial.panasonic.com/ac/e/>

Through hole terminal type

CAD Data

External dimensions

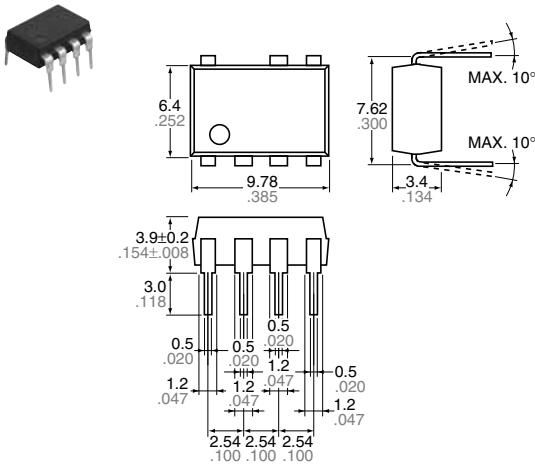

Terminal thickness: 0.25 .010
General tolerance: $\pm 0.1 \pm .004$

PC board pattern (BOTTOM VIEW)

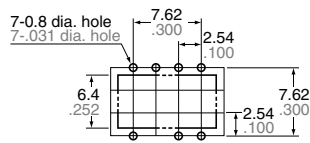

Tolerance: $\pm 0.1 \pm .004$

Surface mount terminal type

CAD Data

External dimensions

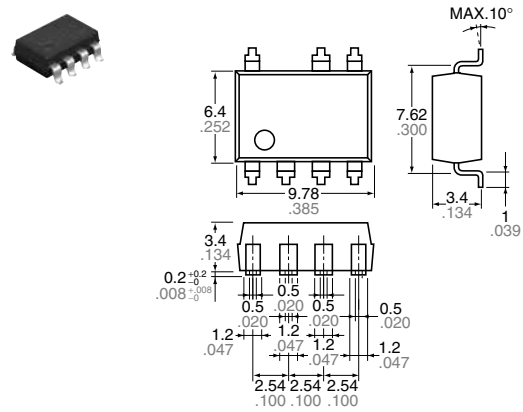

Terminal thickness: 0.25 .010
General tolerance: $\pm 0.1 \pm .004$

Recommended mounting pad (TOP VIEW)

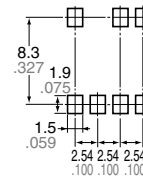

Tolerance: $\pm 0.1 \pm .004$

SCHEMATIC AND WIRING DIAGRAMS

Notes: E_1 : Power source at input side; I_F : Trigger LED forward current; V_L : Load voltage; I_L : Load current

Schematic	Output configuration	Load	Wiring diagram
<p>10 + 20 - 30 - 40</p> <p>Zero-cross circuit</p> <p>8 6 5</p>	<p>1a</p>	<p>AC</p>	<p>10 20 30 40</p> <p>8 6 5</p> <p>Load</p> <p>I_L</p> <p>V_L (AC)</p>
<p>10 + 20 - 30 - 40</p> <p>Zero-cross circuit</p> <p>8 6 5</p>			