

Ideal for power supply
1a/1c/2a/2c/5A/10A
power relays

JW RELAYS



RoHS compliant

FEATURES

- Miniature package with universal terminal footprint
- High dielectric withstanding for transient protection:
10,000 V surge in μ s between coil and contact
- Sealed construction
- Class B coil insulation types available
- TV rated (TV-5) types available (only for 1 Form A type)
- VDE, TÜV, SEMKO, SEV, FIMKO, TV-5 also approved
- Sockets are available.

TYPICAL APPLICATIONS

- 1. Home appliances**
TV sets, VCR, Microwave ovens
- 2. Office machines**
Photocopiers, Vending machines
- 3. Industrial equipment**
NC machines, Robots, Temperature controllers

ORDERING INFORMATION

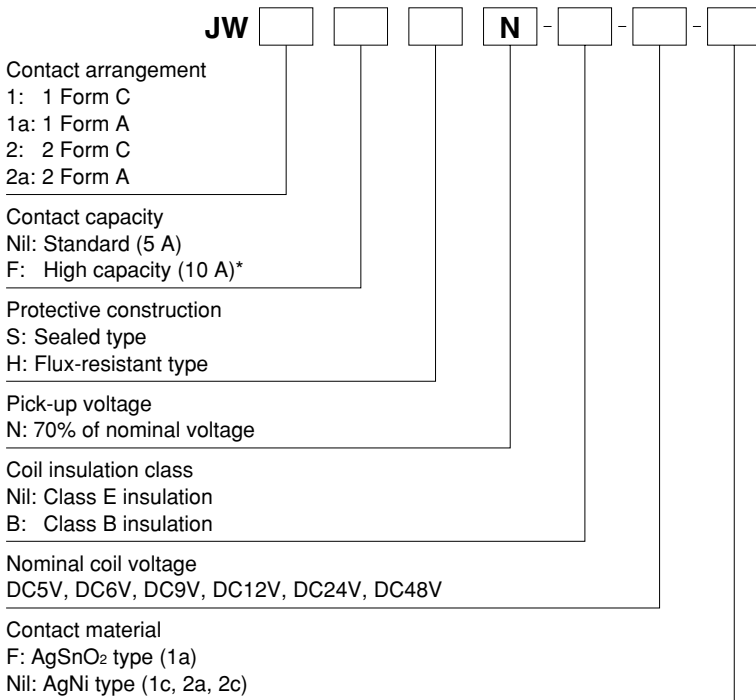

*Only for 1 Form A and 1 Form C type
Certified by UL, CSA, VDE, SEMKO, FIMKO and SEV
Note: When ordering TV rated (TV-5) types, add suffix-TV (available only for 1 Form A type).

TYPES

1) 1 Form A Standard (5A) type

Nominal coil voltage	Sealed type	Flux-resistant type
	Part No.	Part No.
5V DC	JW1aSN-DC5V-F	JW1aHN-DC5V-F
6V DC	JW1aSN-DC6V-F	JW1aHN-DC6V-F
9V DC	JW1aSN-DC9V-F	JW1aHN-DC9V-F
12V DC	JW1aSN-DC12V-F	JW1aHN-DC12V-F
24V DC	JW1aSN-DC24V-F	JW1aHN-DC24V-F
48V DC	JW1aSN-DC48V-F	JW1aHN-DC48V-F

Standard packing: Carton 100 pcs. Case 500 pcs.

3) 1 Form C Standard (5A) type

Nominal coil voltage	Sealed type	Flux-resistant type
	Part No.	Part No.
5V DC	JW1SN-DC5V	JW1HN-DC5V
6V DC	JW1SN-DC6V	JW1HN-DC6V
9V DC	JW1SN-DC9V	JW1HN-DC9V
12V DC	JW1SN-DC12V	JW1HN-DC12V
24V DC	JW1SN-DC24V	JW1HN-DC24V
48V DC	JW1SN-DC48V	JW1HN-DC48V

Standard packing: Carton 100 pcs. Case 500 pcs.

5) 2 Form A Standard (5A) type

Nominal coil voltage	Sealed type	Flux-resistant type
	Part No.	Part No.
5V DC	JW2aSN-DC5V	JW2aHN-DC5V
6V DC	JW2aSN-DC6V	JW2aHN-DC6V
9V DC	JW2aSN-DC9V	JW2aHN-DC9V
12V DC	JW2aSN-DC12V	JW2aHN-DC12V
24V DC	JW2aSN-DC24V	JW2aHN-DC24V
48V DC	JW2aSN-DC48V	JW2aHN-DC48V

Standard packing: Carton 100 pcs. Case 500 pcs.

2) 1 Form A High capacity (10 A) type

Nominal coil voltage	Sealed type	Flux-resistant type
	Part No.	Part No.
5V DC	JW1aFSN-DC5V-F	JW1aFHN-DC5V-F
6V DC	JW1aFSN-DC6V-F	JW1aFHN-DC6V-F
9V DC	JW1aFSN-DC9V-F	JW1aFHN-DC9V-F
12V DC	JW1aFSN-DC12V-F	JW1aFHN-DC12V-F
24V DC	JW1aFSN-DC24V-F	JW1aFHN-DC24V-F
48V DC	JW1aFSN-DC48V-F	JW1aFHN-DC48V-F

Standard packing: Carton 100 pcs. Case 500 pcs.

4) 1 Form C High capacity (10 A) type

Nominal coil voltage	Sealed type	Flux-resistant type
	Part No.	Part No.
5V DC	JW1FNSN-DC5V	JW1FHNSN-DC5V
6V DC	JW1FNSN-DC6V	JW1FHNSN-DC6V
9V DC	JW1FNSN-DC9V	JW1FHNSN-DC9V
12V DC	JW1FNSN-DC12V	JW1FHNSN-DC12V
24V DC	JW1FNSN-DC24V	JW1FHNSN-DC24V
48V DC	JW1FNSN-DC48V	JW1FHNSN-DC48V

Standard packing: Carton 100 pcs. Case 500 pcs.

6) 2 Form C Standard (5A) type

Nominal coil voltage	Sealed type	Flux-resistant type
	Part No.	Part No.
5V DC	JW2SN-DC5V	JW2HN-DC5V
6V DC	JW2SN-DC6V	JW2HN-DC6V
9V DC	JW2SN-DC9V	JW2HN-DC9V
12V DC	JW2SN-DC12V	JW2HN-DC12V
24V DC	JW2SN-DC24V	JW2HN-DC24V
48V DC	JW2SN-DC48V	JW2HN-DC48V

Standard packing: Carton 100 pcs. Case 500 pcs.

Note: Class B coil insulation type is available.
Ex) JW1aSN-B-DC12V-F

* For sockets, see page 140.

RATING

1. Coil data

Nominal coil voltage	Pick-up voltage (at 20°C 68°F)	Drop-out voltage (at 20°C 68°F)	Nominal operating current [±10%] (at 20°C 68°F)	Coil resistance [±10%] (at 20°C 68°F)	Nominal operating power	Max. applied voltage (at 20°C 68°F)
5V DC	70%V or less of nominal voltage (Initial)	10%V or more of nominal voltage (Initial)	106mA	47Ω	530mW	130%V of nominal voltage (at 60°C 140°F) 120%V of nominal voltage (at 85°C 185°F)*4
6V DC			88mA	68Ω		
9V DC			58mA	155Ω		
12V DC			44mA	270Ω		
24V DC			22mA	1,100Ω		
48V DC			11mA	4,400Ω		

2. Specifications

Characteristics	Item	Specifications		
		Standard type	High capacity type	
Contact	Contact material	1 Form A: AgSnO ₂ type 1 Form C, 2 Form A and 2 Form C: AgNi type		
	Arrangement	1 Form A, 1 Form C, 2 Form A and 2 Form C	1 Form A and 1 Form C	
	Contact resistance (Initial)	Max. 100 mΩ (By voltage drop 6 V DC 1A)		
Rating	Nominal switching capacity (resistive load)	5A 250V AC, 5A 30V DC	10A 250V AC, 10A 30V DC	
	Max. switching power (resistive load)	1,250VA, 150W	2,500VA, 300W	
	Max. switching voltage	250V AC, 30V DC		
	Max. switching current	5A	10A	
	Min. switching capacity (reference value)*1	100mA, 5V DC		
Electrical characteristics	Insulation resistance (Initial)	Min. 1,000MΩ (at 500V DC) Measurement at same location as "Breakdown voltage" section.		
	Breakdown voltage (Initial)	Between open contacts	1,000 Vrms for 1 min. (Detection current: 10 mA)	
		Between contact and coil	5,000 Vrms for 1 min. (Detection current: 10 mA)	
		Between contact sets	3,000 Vrms for 1 min. (2 Form A, 2 Form C) (Detection current: 10 mA)	
	Temperature rise (coil)	1 Form A: Max. 45°C 113°F, 1 Form C, 2 Form A and 2 Form C: Max. 55°C 131°F (resistive method, with nominal coil voltage and at nominal switching capacity, at 20°C 68°F)	1 Form A: Max. 45°C 113°F, 1 Form C: Max. 55°C 131°F (resistive method, with nominal coil voltage and at nominal switching capacity, at 20°C 68°F)	
	Surge breakdown voltage*2 (Between contact and coil) (Initial)	10,000 V		
	Operate time (at nominal voltage) (at 20°C 68°F)	Max. 15 ms (excluding contact bounce time.)		
Release time (at nominal voltage) (at 20°C 68°F)	Max. 5 ms (excluding contact bounce time) (Without diode)			
Mechanical characteristics	Shock resistance	Functional	98 m/s ² (Half-wave pulse of sine wave: 11 ms; detection time: 10μs.)	
		Destructive	980 m/s ² (Half-wave pulse of sine wave: 6 ms.)	
	Vibration resistance	Functional	10 to 55 Hz at double amplitude of 1.6 mm (Detection time: 10μs.)	
		Destructive	10 to 55 Hz at double amplitude of 2.0 mm	
Expected life	Mechanical (at 180 times/min.)	Min. 5×10 ⁶		
	Electrical (at 6 times/min.)	Min. 10 ⁵ (at resistive load)		
Conditions	Conditions for operation, transport and storage*3	Ambient temperature*: -40°C to +60°C -40°F to 140°F (Class E), (Class B: -40°C to +85°C -40°F to 185°F) Humidity: 5 to 85% R.H. (Not freezing and condensing at low temperature)		
	Max. operating speed (at nominal switching capacity)	Flux-resistant type: 20 times/min., Sealed type: 6 times/min.		
Unit weight		Approx. 13 g .46 oz		

* Specifications will vary with foreign standards certification ratings.

Notes: *1. This value can change due to the switching frequency, environmental conditions, and desired reliability level, therefore it is recommended to check this with the actual load.

*2. Wave is standard shock voltage of ±1.2×50μs according to JEC-212-1981

*3. The upper limit of the ambient temperature is the maximum temperature that can satisfy the coil temperature rise value. Refer to Usage, transport and storage conditions in NOTES.

*4. The pick-up and drop out voltages rise approximately 0.4% for every 1°C 33.8°F given a standard ambient temperature of 20°C 68°F. Therefore, when using relays where the ambient temperature is high, please take into consideration the rise in pick-up and drop out voltages and keep the coil applied voltage within the maximum applied voltage.

REFERENCE DATA

JW 1 Form A Standard (5A) type

1. Maximum operating power

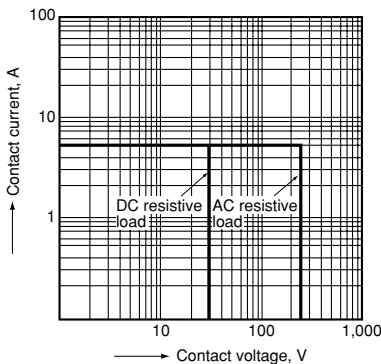

2. Operate/release time

Sample: JW1aSN-DC12V-F, 10 pcs.
Ambient temperature: 20°C 68°F

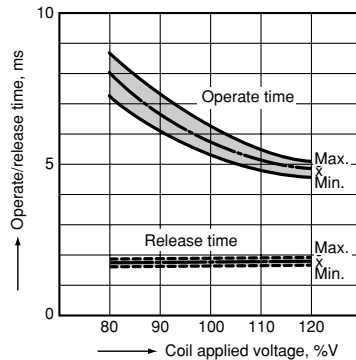

3. Life curve

1 Form A Standard (5 A) type

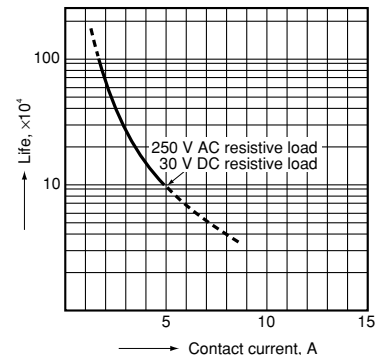

JW 1 Form A High Capacity (10 A) type

1. Maximum operating power

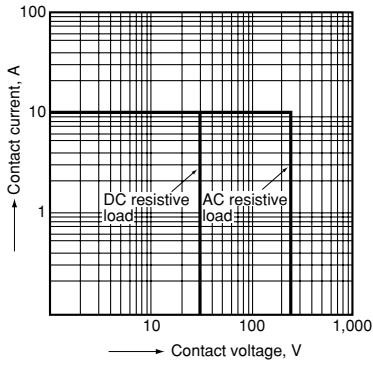

2. Operate/release time

Sample: JW1aFSN-DC12V, 10 pcs.
Ambient temperature: 20°C 68°F

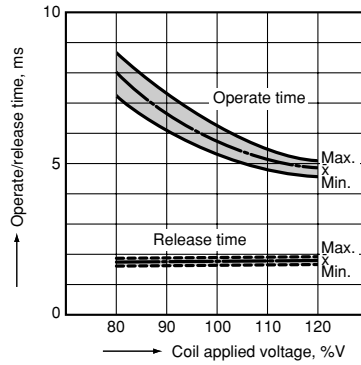

3. Life curve

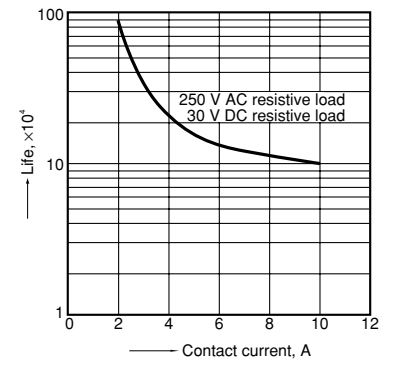

4-(1). Coil temperature rise
(Contact carrying current: 5A)

Sample JW1aFSN-DC12V-F, 6 pcs.
Point measured: Inside the coil

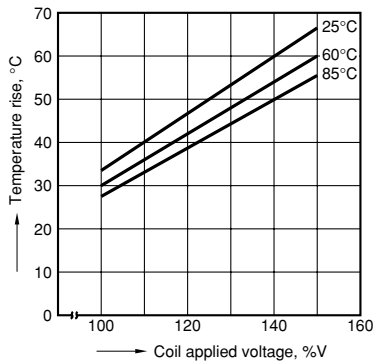

4-(2). Coil temperature rise
(Contact carrying current: 10 A)

Sample: JW1aFSN-DC12V-F, 6 pcs.
Point measured: Inside the coil

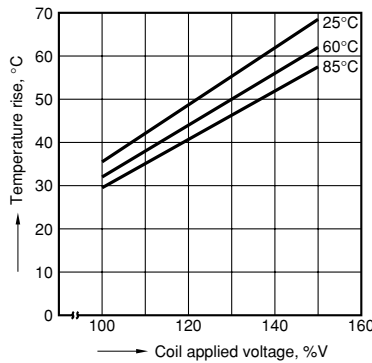

JW 1 Form C Standard (5 A) type

1-(3). Maximum operating power

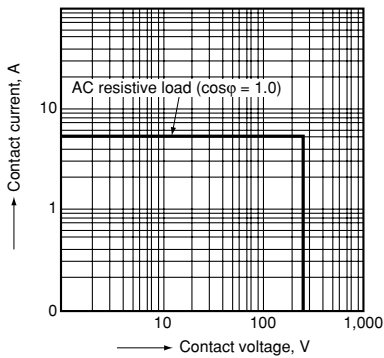

2. Operate/release time

Sample: JW1SN-DC12V-F, 6 pcs.
Ambient temperature: 20°C 68°F

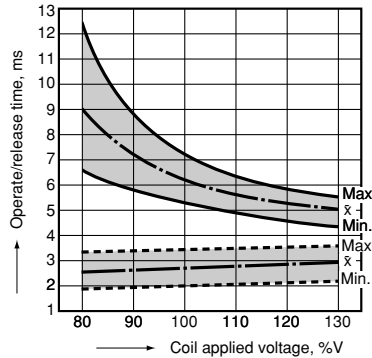

JW 1 Form C High Capacity (10 A) type

1. Maximum operating power

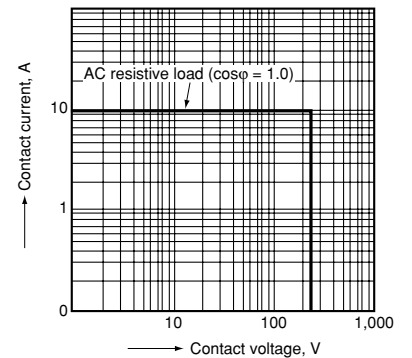

JW 2 Form A Standard (5 A) type

1. Maximum operating power

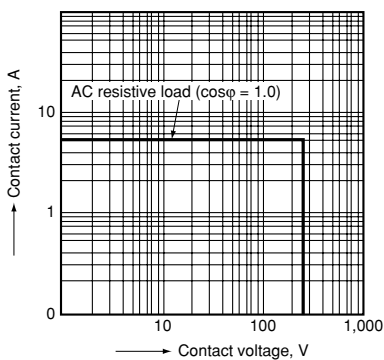

2. Operate/release time

Sample: JW2aSN-DC24V-F, 6 pcs.
Ambient temperature: 20°C 68°F

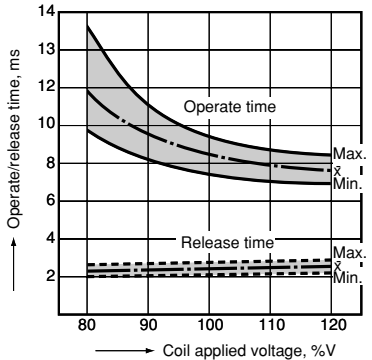

JW 2 Form C Standard (5 A) type

1. Maximum operating power

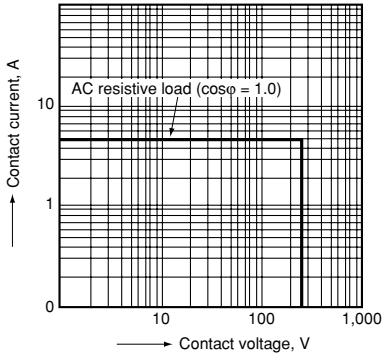

2. Operate/release time

Sample: JW2SN-DC12V-F, 6 pcs.
Ambient temperature: 20°C 68°F

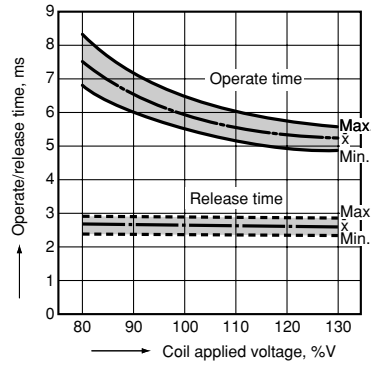

DIMENSIONS (mm inch)

The CAD data of the products with a **CAD Data** mark can be downloaded from: <http://industrial.panasonic.com/ac/e/>

JW 1 Form A

CAD Data



External dimensions

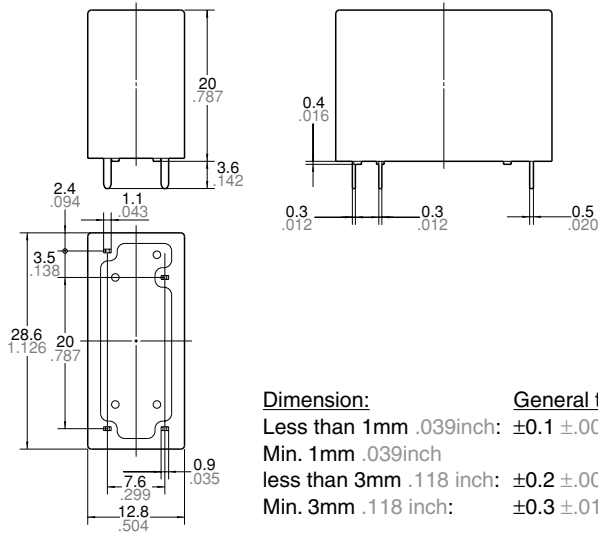

Dimension:
 Less than 1mm .039inch: $\pm 0.1 \pm .004$
 Min. 1mm .039inch
 less than 3mm .118 inch: $\pm 0.2 \pm .008$
 Min. 3mm .118 inch: $\pm 0.3 \pm .012$

General tolerance
 $\pm 0.1 \pm .004$

Wiring diagram (Bottom view)

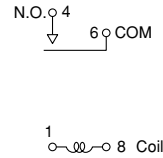

Note: Terminal numbers are not indicated on the relay.

PC board pattern (Bottom view)

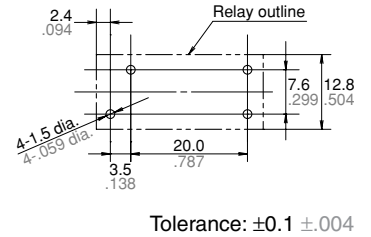

Tolerance: $\pm 0.1 \pm .004$

JW 1 Form C

CAD Data

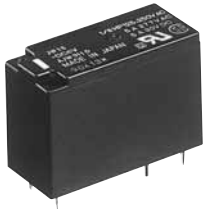

External dimensions

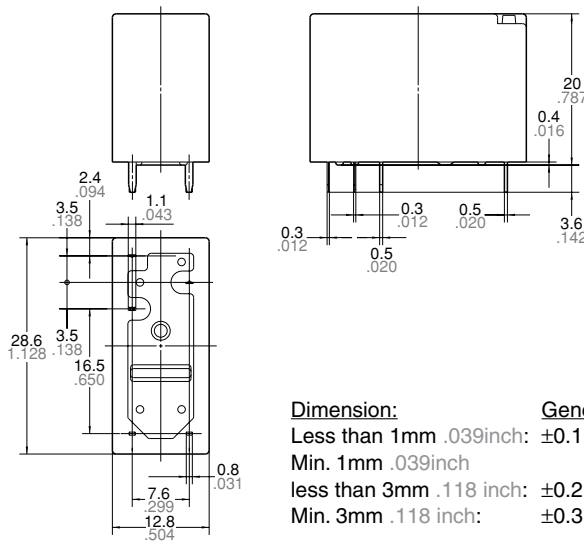

Dimension:
 Less than 1mm .039inch: $\pm 0.1 \pm .004$
 Min. 1mm .039inch
 less than 3mm .118 inch: $\pm 0.2 \pm .008$
 Min. 3mm .118 inch: $\pm 0.3 \pm .012$

General tolerance
 $\pm 0.1 \pm .004$

Wiring diagram (Bottom view)

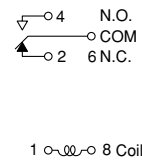

Note: Terminal numbers are not indicated on the relay.

PC board pattern (Bottom view)

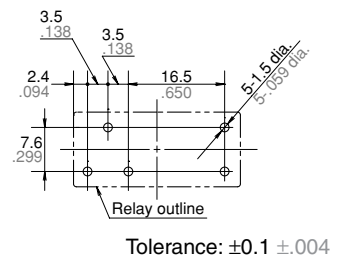

Tolerance: $\pm 0.1 \pm .004$

JW 2 Form A and 2 Form C

CAD Data

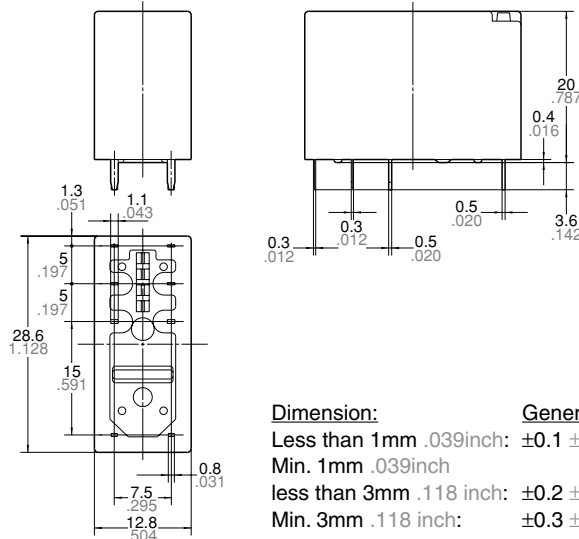

Wiring diagram (Bottom view)

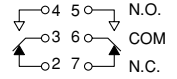

1 $\text{---} \text{---} \text{---} \text{---} \text{---} \text{---} \text{---} \text{---} \text{---}$ 8 Coil

Note: Terminal numbers are not indicated on the relay.

PC board pattern (Bottom view)

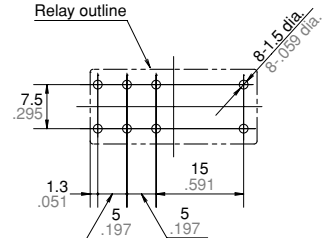

Note: JW 2 Form A is as shown in the diagram above except the N.C. terminals are not present.

SAFETY STANDARDS

Item	UL/C-UL (Recognized)		CSA (Certified)		VDE (Certified)		TV rating (UL/CSA)		TÜV (Certified)		SEMKO (Certified)		FIMKO		SEV	
	File No.	Contact rating	File No.	Contact rating	File No.	Contact rating	File No.	Rating	File No.	Rating	File No.	Contact rating	File No.	Contact rating	File No.	Contact rating
Standard type 1 Form A	E43028	5A 277V AC 5A 30V DC 1/8HP 125V AC 1/8HP 250V AC	LR26550 etc.	5A 277V AC 5A 30V DC 1/8HP 125V AC 1/8HP 250V AC B300	40013854	5A 250V AC (cos ϕ =1.0) 3A 250V AC (cos ϕ =0.4) Standard type 5A 30V DC (0ms)	UL E43028 CSA LR26550 etc.	1a \rightarrow TV-5	B 11 05 13461 305	5A 250V AC (cos ϕ =1.0) 3A 250V AC (cos ϕ =0.4) 5A 30V DC (0ms)	817817	5A 250V AC (cos ϕ =1.0) 5A 30V DC (0ms)	24965	5A 250V AC (cos ϕ =1.0) 5A 30V DC (0ms)	11.0262	5A 250V AC (cos ϕ =1.0)
Standard type 1 Form C	E43028	5A 277V AC 5A 30V DC 1/8HP 125V AC 1/8HP 250V AC	LR26550 etc.	5A 277V AC 5A 30V DC 1/8HP 125V AC 1/8HP 250V AC B300	40013854	5A 250V AC (cos ϕ =1.0) 3A 250V AC (cos ϕ =0.4) Standard type 5A 30V DC (0ms)	—	—	B 11 05 13461 305	5A 250V AC (cos ϕ =1.0) 3A 250V AC (cos ϕ =0.4) 5A 30V DC (0ms)	817817	5A 250V AC (cos ϕ =1.0) 5A 30V DC (0ms)	24965	5A 250V AC (cos ϕ =1.0) 5A 30V DC (0ms)	11.0262	5A 250V AC (cos ϕ =1.0)
Standard type 2 Form A	E43028	5A 277V AC 5A 30V DC 1/8HP 125V AC 1/8HP 250V AC B300	LR26550 etc.	5A 277V AC 5A 30V DC 1/8HP 125V AC 1/8HP 250V AC B300	40013854	5A 250V AC (cos ϕ =1.0) 3A 250V AC (cos ϕ =0.4) Standard type 5A 30V DC (0ms)	—	—	B 11 05 13461 305	5A 250V AC (cos ϕ =1.0) 3A 250V AC (cos ϕ =0.4) 5A 30V DC (0ms)	817817	5A 250V AC (cos ϕ =1.0) 5A 30V DC (0ms)	24965	5A 250V AC (cos ϕ =1.0) 5A 30V DC (0ms)	11.0262	5A 250V AC (cos ϕ =1.0)
Standard type 2 Form C	E43028	5A 277V AC 5A 30V DC 1/8HP 125V AC 1/8HP 250V AC B300	LR26550 etc.	5A 277V AC 5A 30V DC 1/8HP 125V AC 1/8HP 250V AC B300	40013854	5A 250V AC (cos ϕ =1.0) 3A 250V AC (cos ϕ =0.4) Standard type 5A 30V DC (0ms)	—	—	B 11 05 13461 305	5A 250V AC (cos ϕ =1.0) 3A 250V AC (cos ϕ =0.4) 5A 30V DC (0ms)	817817	5A 250V AC (cos ϕ =1.0) 5A 30V DC (0ms)	24965	5A 250V AC (cos ϕ =1.0) 5A 30V DC (0ms)	11.0262	5A 250V AC (cos ϕ =1.0)
High capacity type 1 Form A	E43028	10A 277V AC 10A 30V DC 1/8HP 125V AC 1/8HP 250V AC	LR26550 etc.	10A 277V AC 10A 30V DC 1/8HP 125V AC 1/8HP 250V AC B300	40013854	10A 250V AC (cos ϕ =1.0) 7A 250V AC (cos ϕ =0.4) High capacity type 10A 30V DC (0ms)	UL E43028 CSA LR26550	1a \rightarrow TV-5	B 11 05 13461 305	10A 250V AC (cos ϕ =1.0) 7A 250V AC (cos ϕ =0.4) 10A 30V DC (0ms)	817817	10A 250V AC (cos ϕ =1.0) 10A 30V DC (0ms)	24965	10A 250V AC (cos ϕ =1.0) 5A 30V DC (0ms)	11.0262	10A 250V AC (cos ϕ =1.0)
High capacity type 1 Form C	E43028	10A 277V AC 10A 30V DC 1/8HP 125V AC 1/8HP 250V AC	LR26550 etc.	10A 277V AC 10A 30V DC 1/8HP 125V AC 1/8HP 250V AC B300	40013854	10A 250V AC (cos ϕ =1.0) 7A 250V AC (cos ϕ =0.4) High capacity type 10A 30V DC (0ms)	—	—	B 11 05 13461 305	10A 250V AC (cos ϕ =1.0) 7A 250V AC (cos ϕ =0.4) 10A 30V DC (0ms)	817817	10A 250V AC (cos ϕ =1.0) 10A 30V DC (0ms)	24965	10A 250V AC (cos ϕ =1.0) 5A 30V DC (0ms)	11.0262	10A 250V AC (cos ϕ =1.0)