



### FEATURES

#### 1. High frequency characteristics (Impedance 50Ω, ~1.0GHz)

- Insertion loss; Max. 0.3dB
- Isolation; Min. 20dB (Between open contacts)  
Min. 30dB (Between contact sets)
- V.S.W.R.; Max. 1.2

#### 2. Surface mount terminal

This relay is a surface-mounted model with excellent high-frequency properties. In addition, it can use a microstrip line in the base circuit design which spares the labor of machining the base.

#### 3. Low profile small type

9.7(W)×14.7(L)×5.9(H) mm  
.382(W)×.579(L)×.232(H) inch

**4. High sensitivity: 140 mW nominal operating power (Single side stable, 2 coil latching)**

**5. High contact reliability**  
**Electrical life: Min. 10<sup>7</sup> (10mA 10V DC)**

### TYPICAL APPLICATIONS

- **Measurement instruments**  
Oscilloscope attenuator circuit
- **All types of communication device**

If you wish to use in applications with low level loads or with high frequency switching, please consult us.

**RoHS compliant**

### ORDERING INFORMATION

	<b>ARA</b>	<b>2</b>		<b>0</b>	<b>A</b>			
RA relays								
Contact arrangement 2: 2 Form C								
Operating function 0: Single side stable 1: 1 coil latching 2: 2 coil latching								
Type of operation 0: Standard type (B.B.M)								
Terminal shape A: Surface-mount terminal								
Coil voltage, V DC 1H: 1.5, 03: 3, 4H: 4.5, 05: 5, 06: 6, 09: 9, 12: 12, 24: 24, 48: 48 (H=0.5)								
Packing style Nil: Tube packing X: Tape and reel packing (picked from 1 pin side) Z: Tape and reel packing (picked from 10 pin side)								

### TYPES

#### 1. Tube packing

Contact arrangement	Nominal coil voltage	Part No.		
		Single side stable	1 coil latching	2 coil latching
2 Form C	1.5V DC	ARA200A1H	ARA210A1H	ARA220A1H
	3 V DC	ARA200A03	ARA210A03	ARA220A03
	4.5V DC	ARA200A4H	ARA210A4H	ARA220A4H
	5 V DC	ARA200A05	ARA210A05	ARA220A05
	6 V DC	ARA200A06	ARA210A06	ARA220A06
	9 V DC	ARA200A09	ARA210A09	ARA220A09
	12 V DC	ARA200A12	ARA210A12	ARA220A12
	24 V DC	ARA200A24	ARA210A24	ARA220A24
48 V DC	ARA200A48	—	—	

Standard packing: 40 pcs. in an inner package (tube); 1,000 pcs. in an outer package

# RA (ARA)

## 2. Tape and reel packing

Contact arrangement	Nominal coil voltage	Part No.		
		Single side stable	1 coil latching	2 coil latching
2 Form C	1.5V DC	ARA200A1HZ	ARA210A1HZ	ARA220A1HZ
	3 V DC	ARA200A03Z	ARA210A03Z	ARA220A03Z
	4.5V DC	ARA200A4HZ	ARA210A4HZ	ARA220A4HZ
	5 V DC	ARA200A05Z	ARA210A05Z	ARA220A05Z
	6 V DC	ARA200A06Z	ARA210A06Z	ARA220A06Z
	9 V DC	ARA200A09Z	ARA210A09Z	ARA220A09Z
	12 V DC	ARA200A12Z	ARA210A12Z	ARA220A12Z
	24 V DC	ARA200A24Z	ARA210A24Z	ARA220A24Z
	48 V DC	ARA200A48Z	—	—

Standard packing: 500 pcs. in an inner package (tape and reele); 1,000 pcs. in an outer package

Note: Tape and reel packing symbol "-Z" is not marked on the relay. "X" type tape and reel packing (picked from 1-pin side) is also available.

## RATING

### 1. Coil data

#### 1) Single side stable

Nominal coil voltage	Pick-up voltage (at 20°C 68°F)	Drop-out voltage (at 20°C 68°F)	Nominal operating current [±10%] (at 20°C 68°F)	Coil resistance [±10%] (at 20°C 68°F)	Nominal operating power	Max. applied voltage (at 20°C 68°F)
1.5V DC	75%V or less of nominal voltage* (Initial)	10%V or more of nominal voltage* (Initial)	93.8mA	16 Ω	140mW	150%V of nominal voltage
3 V DC			46.7mA	64.3Ω		
4.5V DC			31 mA	145 Ω		
5 V DC			28.1mA	178 Ω		
6 V DC			23.3mA	257 Ω		
9 V DC			15.5mA	579 Ω		
12 V DC			11.7mA	1,028 Ω	200mW	
24 V DC			8.3mA	2,880 Ω		
48 V DC			6.3mA	7,680 Ω	300mW	120%V of nominal voltage

#### 2) 1 coil latching

Nominal coil voltage	Set voltage (at 20°C 68°F)	Reset voltage (at 20°C 68°F)	Nominal operating current [±10%] (at 20°C 68°F)	Coil resistance [±10%] (at 20°C 68°F)	Nominal operating power	Max. applied voltage (at 20°C 68°F)
1.5V DC	75%V or less of nominal voltage* (Initial)	75%V or less of nominal voltage* (Initial)	46.9mA	32 Ω	70mW	150%V of nominal voltage
3 V DC			23.3mA	128.6Ω		
4.5V DC			15.6mA	289.3Ω		
5 V DC			14 mA	357 Ω		
6 V DC			11.7mA	514 Ω		
9 V DC			7.8mA	1,157 Ω		
12 V DC			5.8mA	2,057 Ω	100mW	
24 V DC			4.2mA	5,760 Ω		

#### 3) 2 coil latching

Nominal coil voltage	Set voltage (at 20°C 68°F)	Reset voltage (at 20°C 68°F)	Nominal operating current [±10%] (at 20°C 68°F)	Coil resistance [±10%] (at 20°C 68°F)	Nominal operating power	Max. applied voltage (at 20°C 68°F)
1.5V DC	75%V or less of nominal voltage* (Initial)	75%V or less of nominal voltage* (Initial)	93.8mA	16 Ω	140mW	150%V of nominal voltage
3 V DC			46.7mA	64.3Ω		
4.5V DC			31 mA	145 Ω		
5 V DC			28.1mA	178 Ω		
6 V DC			23.3mA	257 Ω		
9 V DC			15.5mA	579 Ω		
12 V DC			11.7mA	1,028 Ω	200mW	
24 V DC			8.3mA	2,880 Ω		

\*Pulse drive (JIS C5442-1996)

**2. Specifications**

Characteristics	Item	Specifications	
Contact	Arrangement	2 Form C	
	Contact material	Stationary: AgPd + Au clad, Movable: AgPd	
	Initial contact resistance, max.	Max. 75mΩ (By voltage drop 6V DC 1A)	
Rating	Contact rating	10mA 10V DC (resistive load), 1A 30V DC (resistive load)	
	Contact carrying power	3W (at 1GHz, impedance 50Ω, V.S.W.R. max.1.2)	
	Max. switching voltage	30V DC	
	Max. switching current	1A	
	Nominal operating power	Single side stable 1 coil latching 2 coil latching	140mW (1.5 to 12V), 200mW (24V), 300mW (48V) 70 mW (1.5 to 12V), 100mW (24V) 140mW (1.5 to 12V), 200mW (24V)
High frequency characteristics (Initial) (~1GHz, Impedance 50Ω)	Isolation	Between open contacts	Min. 20dB
		Between contact sets	Min. 30dB
	Insertion loss (without D.U.T. board's loss)	Max. 0.3dB	
	V.S.W.R.	Max. 1.2	
Input power	3W (at 1GHz, impedance 50Ω, V.S.W.R. max.1.2)		
Electrical characteristics	Insulation resistance (Initial)		Min. 100MΩ (at 500V DC) Measurement at same location as "Initial breakdown voltage" section.
	Breakdown voltage (Initial)	Between open contacts	750 Vrms for 1min. (Detection current: 10mA)
		Between contact sets	1,000 Vrms for 1min. (Detection current: 10mA)
		Between contact and coil	1,000 Vrms for 1min. (Detection current: 10mA)
		Between contact and earth terminal	1,000 Vrms for 1min. (Detection current: 10mA)
	Temperature rise (at 20°C)		Max. 60°C (By resistive method, nominal voltage applied to the coil, 1GHz, 3W, V.S.W.R. max.1.2)
	Operate time [Set time] (at 20°C)		Max. 4ms (Approx. 2ms) [Max. 4ms (Approx. 2ms)] (Nominal operating voltage applied to the coil, excluding contact bounce time.)
Release time [Reset time] (at 20°C)		Max. 4ms (Approx. 1ms) [Max. 4ms (Approx. 2ms)] (Nominal operating voltage applied to the coil, excluding contact bounce time.) (without diode)	
Mechanical characteristics	Shock resistance	Functional	Min. 500 m/s <sup>2</sup> (Half-wave pulse of sine wave: 11ms; detection time: 10μs.)
		Destructive	Min. 1,000 m/s <sup>2</sup> (Half-wave pulse of sine wave: 6ms.)
	Vibration resistance	Functional	10 to 55 Hz at double amplitude of 3mm (Detection time: 10μs.)
		Destructive	10 to 55 Hz at double amplitude of 5mm
Expected life	Mechanical		Min. 10 <sup>8</sup> (at 180 cpm)
	Electrical		Min. 10 <sup>7</sup> (at 20 cpm) (10mA 10V DC resistive load) Min. 10 <sup>5</sup> (at 20 cpm) (1A 30V DC resistive load)
Conditions	Conditions for operation, transport and storage*		Ambient temperature: -40°C to +85°C -40°F to +185°F Humidity: 5 to 85% R.H. (Not freezing and condensing at low temperature)
Unit weight			Approx. 2 g .07 oz

Note: \* The upper operation ambient temperature limit is the maximum temperature that can satisfy the coil temperature rise value. Refer to [6] AMBIENT ENVIRONMENT in GENERAL APPLICATION GUIDELINES.

**REFERENCE DATA**

1-(1). High frequency characteristics (Impedance 50Ω)

Sample: ARA200A12

Measuring method: Measured with HP network analyzer (HP8753C).

• V.S.W.R.

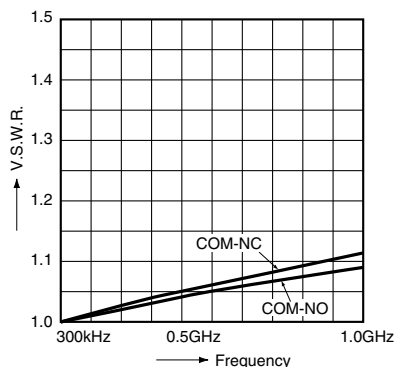

• Insertion loss

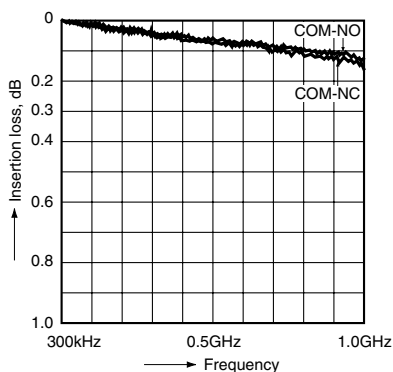

• Isolation

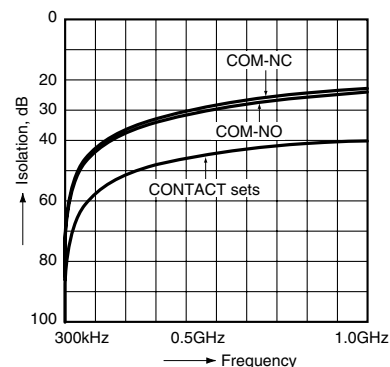

# RA (ARA)

1-(2). High frequency characteristics (Impedance 75Ω)

Sample: ARA200A12

Measuring method: Measured with HP network analyzer (HP8753C).

• V.S.W.R.

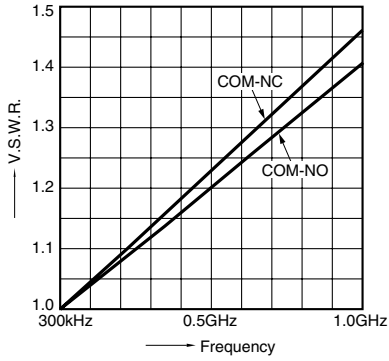

• Insertion loss

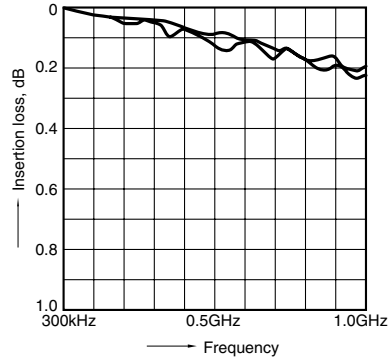

• Isolation

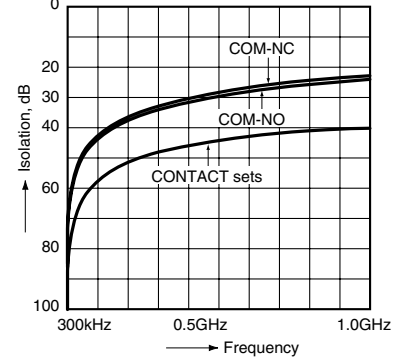

## DIMENSIONS (mm inch)

The CAD data of the products with a **CAD Data** mark can be downloaded from: <http://industrial.panasonic.com/ac/e/>

**CAD Data**

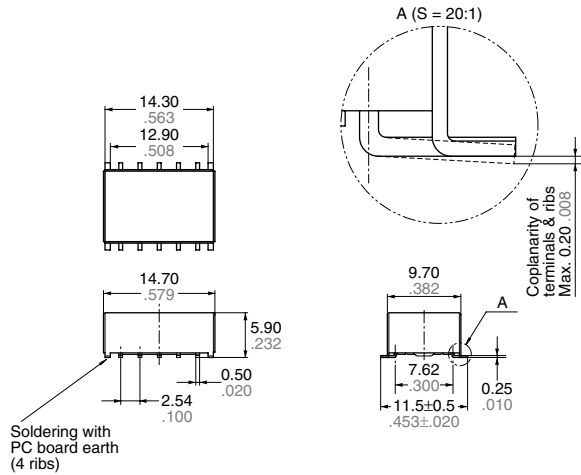

Tolerance:  $\pm 0.3 \pm 0.12$

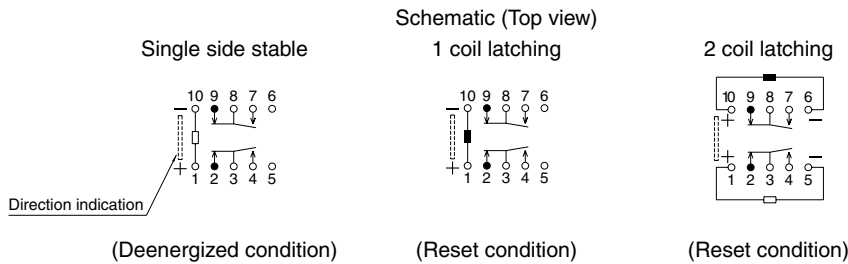

Note: Please consult us regarding recommended PC board patterns.

**NOTES**

**1. Coil operating power**

Pure DC current should be applied to the coil. The wave form should be rectangular. If it includes ripple, the ripple factor should be less than 5%. However, check it with the actual circuit since the characteristics may be slightly different. The nominal operating voltage should be applied to the coil for more than 10 ms to set/reset the latching type relay.

**2. Coil connection**

When connecting coils, refer to the wiring diagram to prevent mis-operation or malfunction.

**3. External magnetic field**

Since RA relays are highly sensitive polarized relays, their characteristics will be affected by a strong external magnetic field. Avoid using the relay under that condition.

**4. Cleaning**

For automatic cleaning, the boiling method is recommended. Avoid ultrasonic cleaning which subjects the relays to high frequency vibrations, which may cause the contacts to stick. It is recommended that alcoholic solvents be used.

**5. Tape and reel packing**

1) Tape dimensions

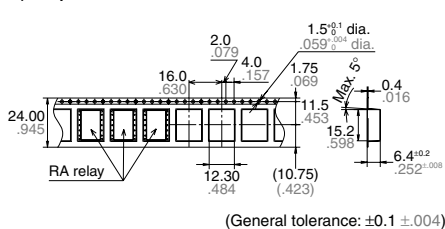

2) X type, Z type

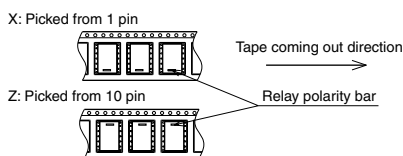

3) Dimensions of plastic reel

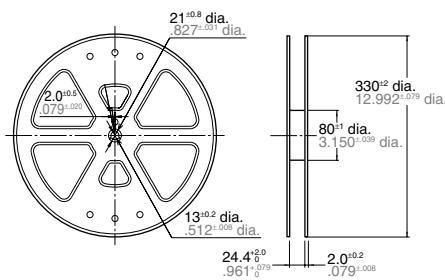

**6. Soldering**

Manual soldering shall be performed under following condition.  
Tip temperature: 280°C to 300°C 536°F to 572°F.

Wattage: 30 to 60W

Soldering time: within 5s

In case of automatic soldering, the following conditions should be observed

1) Position of measuring temperature

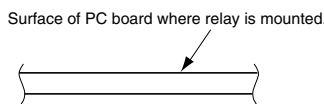

2) IR (infrared reflow) soldering method

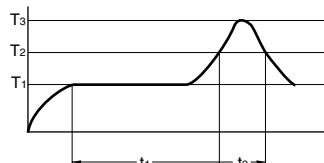

T<sub>1</sub> = 150 to 180°C 302 to 356°F      t<sub>1</sub> = 60 to 120 sec.  
T<sub>2</sub> = 230°C 446°F and higher      t<sub>2</sub> = Within 30 sec.  
T<sub>3</sub> = Within 250°C 482°F

Temperature rise of relay itself may vary according to the mounting level or the heating method of reflow equipment. Therefore, please set the temperature of soldering portion of relay terminal and the top surface of the relay case not to exceed the above mentioned soldering condition.

It is recommended to check the temperature rise of each portion under actual mounting condition before use. The soldering earth shall be performed by manual soldering.

**7. Conditions for operation, transport and storage conditions**

1) Ambient temperature, humidity, and atmospheric pressure during usage, transport, and storage of the relay:

- (1) Temperature: -40 to +70°C -40 to +158°F
  - (2) Humidity: 5 to 85% RH (Avoid freezing and condensation.) The humidity range varies with the temperature. Use within the range indicated in the graph below.
  - (3) Atmospheric pressure: 86 to 106 kPa
- Temperature and humidity range for usage, transport, and storage:

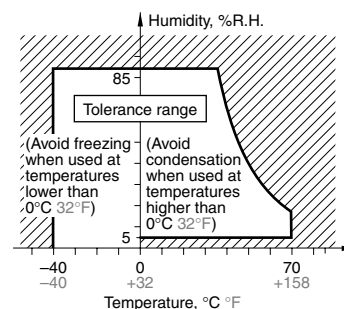

2) Condensation

Condensation forms when there is a sudden change in temperature under high temperature and high humidity conditions. Condensation will cause deterioration of the relay insulation.

3) Freezing

Condensation or other moisture may freeze on the relay when the temperature is lower than 0°C 32°F. This causes problems such as sticking of movable parts or operational time lags.

4) Low temperature, low humidity environments

The plastic becomes brittle if the relay is exposed to a low temperature, low humidity environment for long periods of time.

**For general cautions for use, please refer to the "General Application Guidelines".**