

Products with diode inside  are discontinued in 2014.

**Panasonic**  
ideas for life

Automotive micro-ISO relay

CM RELAYS



 Products to be discontinued.

## FEATURES

- **Micro-ISO type terminals**
- **Small size:**  
20 mm(L)×15 mm(W)×22 mm(H)  
.787 inch(L)×.591 inch(L)×.866 inch(H)
- **Wide line-up**  
PC board type, plug-in type and resistor and  diode inside type.  
24V DC type is also available.
- **Compact and high-capacity 35A load switching**  
N.O.: 35A 14V DC, N.C.: 20A 14V DC (Sealed type)  
Min.  $5 \times 10^4$   
N.O.: 35A 14V DC, N.C.: 20A 14V DC (Flux-resistant type)  
Min.  $10^5$  \*12V DC type

- **Uses international standard ISO terminal arrangement.**

The ISO international standard terminal arrangement is used.

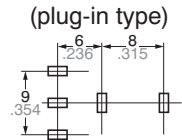

## TYPICAL APPLICATIONS

- Fan motor
- Heater
- Head lamp
- Air Compressor
- EPS
- ABS
- Blower fan
- Defogger, etc.

## SPECIFICATIONS

### Contact

| Type   | 12 V coil voltage  | 24 V coil voltage  |
|--|--|--|
| Arrangement  | 1 Form A, 1 Form C   |  |
| Contact material   | Ag alloy (Cadmium free)  |  |
| Initial contact resistance (Initial)<br>(By voltage drop 6 V DC 1 A) | Typ. 2 mΩ  |  |
| Contact voltage drop   | Max. N.O.: 0.5 V<br>(at 35 A 14 V DC)<br>Max. N.C.: 0.3 V<br>(at 20 A 14 V DC) | Max. N.O.: 0.3 V<br>(at 15 A 28 V DC)<br>Max. N.C.: 0.2 V<br>(at 8 A 28 V DC)          |
| Rating<br>(resistive load)   | Nominal switching capacity   | N.O.: 35 A 14 V DC<br>N.C.: 20 A 14 V DC   |
|  | Max. carrying current  | N.O.: 20 A<br>(14 V DC,<br>at 85°C 185°F)<br>N.C.: 10 A<br>(14 V DC,<br>at 85°C 185°F) |
|  | Min. switching capacity <sup>#1</sup>  | 1 A 12 V DC  |
| Expected life  | Mechanical<br>(at 120 cpm)   | Min. $10^6$  |
|  | Electrical<br>(at rated load)  | Flux-resistant type: Min. $10^{5*1}$<br>Sealed type: Min. $5 \times 10^4$              |

### Coil

| Nominal operating power | 1.5 W<br>1.7 W<br>(with resistor inside type) | 1.8 W<br>2.0 W<br>(with resistor inside type) |
|-------------------------|---|---|
|-------------------------|---|---|

#1 This value can change due to the switching frequency, environmental conditions, and desired reliability level, therefore it is recommended to check this with the actual load.

### Characteristics

| Type   | 24V coil type                                      | 12V coil type  |
|--|--|--|
| Max. operating speed<br>(at nominal switching capacity)  | 15 cpm   |  |
| Initial insulation resistance* <sup>2</sup>  | Min. 20 MΩ (at 500 V DC)                           |  |
| Initial breakdown voltage* <sup>3</sup>  | Between open contacts                              | 500 Vrms for 1 min.                                      |
|  | Between contacts and coil                          | 500 Vrms for 1 min.                                      |
| Operate time* <sup>4</sup><br>(at nominal voltage) (at 20°C 85°F)  | Max. 10 ms (initial)                               |  |
| Release time* <sup>4</sup><br>(at nominal voltage) (at 20°C 85°F)  | Max. 10 ms<br>Max. 15 ms<br>(with diode) (initial) |  |
| Shock resistance   | Functional* <sup>5</sup>                           | Min. 200 m/s <sup>2</sup> {20G}                          |
|  | Destructive* <sup>6</sup>                          | Min. 1,000m/s <sup>2</sup> {100G}                        |
| Vibration resistance   | Functional   | 10 Hz to 500 Hz,<br>Min. 44.1 m/s <sup>2</sup> {4.5 G}   |
|  | Destructive* <sup>7</sup>                          | 10 Hz to 2,000 Hz,<br>Min. 44.1 m/s <sup>2</sup> {4.5 G} |
| Conditions for operation, transport and storage* <sup>8</sup> (Not freezing and condensing at low temperature) | Ambient temp.                                      | -40°C to + 85°C<br>-40°F to + 185°F                      |
|  | Humidity   | 5% R.H. to 85% R.H.                                      |
| Mass   | Approx. 20g .71oz                                  |  |

### Remarks

- \*<sup>1</sup> At nominal switching capacity, operating frequency: 2s ON, 2s OFF
- \*<sup>2</sup> Measurement at same location as "Initial breakdown voltage" section.
- \*<sup>3</sup> Detection current: 10mA
- \*<sup>4</sup> Excluding contact bounce time.
- \*<sup>5</sup> Half-wave pulse of sine wave: 11 ms; detection time: 10 μs
- \*<sup>6</sup> Half-wave pulse of sine wave: 6 ms
- \*<sup>7</sup> Time of vibration for each direction; X, Y, Z direction: 4 hours



\*<sup>8</sup> Refer to "6. Usage, Storage and Transport Conditions" in **AMBIENT ENVIRONMENT** section in **Relay Technical Information**.  
Please inquire if you will be using the relay in a high temperature atmosphere.

## ORDERING INFORMATION



| Contact arrangement         | Protective construction                    | Classification of types   | Mounting classification                                  | Coil voltage (DC) |
|-----------------------------|--|---|--|-------------------|
| 1a: 1 Form A<br>1: 1 Form C | Nil: Sealed type<br>F: Flux-resistant type | Nil: Standard type<br>D: with diode inside<br>R: with resistor inside | Nil: Plug-in type<br>P: PC board type<br>(24V type only) | 12 V<br>24 V      |

Note: Bulk package: 50 pcs.; Case: 200 pcs.

 D: with diode inside

## TYPES

Packing quantity: Inner 50pcs, Outer 200pcs.

| Contact arrangement | Part No.  | Coil voltage | Mounting classification | Protective construction |
|---------------------|-----------|--------------|-------------------------|-------------------------|
| 1 Form A            | CM1a-12V  | 12 V DC      | Plug-in type            | Sealed type             |
|                     | CM1aF-12V |              |                         | Flux-resistant type     |
| 1 Form C            | CM1-12V   |              | Plug-in type            | Sealed type             |
|                     | CM1F-12V  |              |                         | Flux-resistant type     |

| Contact arrangement | Part No.    | Coil voltage | Mounting classification | Protective construction |
|---------------------|-------------|--------------|-------------------------|-------------------------|
| 1 Form A            | CM1a-24V    | 24 V DC      | Plug-in type            | Sealed type             |
|                     | CM1aF-24V   |              |                         | Flux-resistant type     |
|                     | CM1a-P-24V  |              | PC board type           | Sealed type             |
|                     | CM1aF-P-24V |              |                         | Flux-resistant type     |
| 1 Form C            | CM1-24V     |              | Plug-in type            | Sealed type             |
|                     | CM1F-24V    |              |                         | Flux-resistant type     |
|                     | CM1-P-24V   |              | PC board type           | Sealed type             |
|                     | CM1F-P-24V  |              |                         | Flux-resistant type     |

## COIL DATA (at 20°C 68°F)

| Nominal voltage, V DC | Pick-up voltage, V DC | Drop-out voltage, V DC | Nominal current, mA | Coil resistance, ohm | Nominal operating power, W | Usable voltage range, V DC |
|-----------------------|-----------------------|------------------------|---------------------|----------------------|----------------------------|----------------------------|
| 12                    | 3 to 7                | 1.2 to 4.2             | 125±10%             | 96±10%               | 1.5                        | 10 to 16                   |
| 24                    | 6 to 14               | 2.4 to 8.4             | 75±10%              | 320±10%              | 1.8                        | 20 to 32                   |

## DIMENSIONS (mm inch)

Download [CAD Data](#) from our Web site.

### 1. Micro-ISO Plug-in type (1 Form C)

[CAD Data](#)

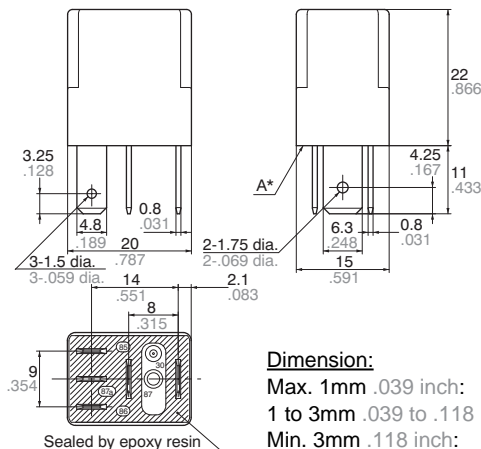

**Dimension:**  
 Max. 1mm .039 inch: ±0.1 ±.004  
 1 to 3mm .039 to .118 inch: ±0.2 ±.008  
 Min. 3mm .118 inch: ±0.3 ±.012

**General tolerance**

Schematic (Bottom view)

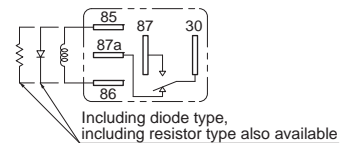

 diode type

\* Intervals between terminals is measured at A surface level.

Products with diode inside  are discontinued in 2014.

**2. Micro-ISO Plug-in type (1 Form A)**

**CAD Data**



|                             |                          |
|-----------------------------|--------------------------|
| <b>Dimension:</b>           | <b>General tolerance</b> |
| Max. 1mm .039 inch:         | $\pm 0.1 \pm 0.04$       |
| 1 to 3mm .039 to .118 inch: | $\pm 0.2 \pm 0.08$       |
| Min. 3mm .118 inch:         | $\pm 0.3 \pm 0.12$       |

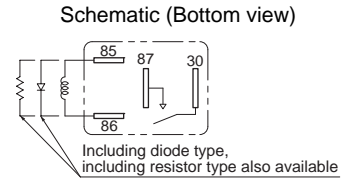

 diode type

mm inch

\* Intervals between terminals is measured at A surface level.

**3. Micro-ISO PC board type (1 Form C)**

**CAD Data**

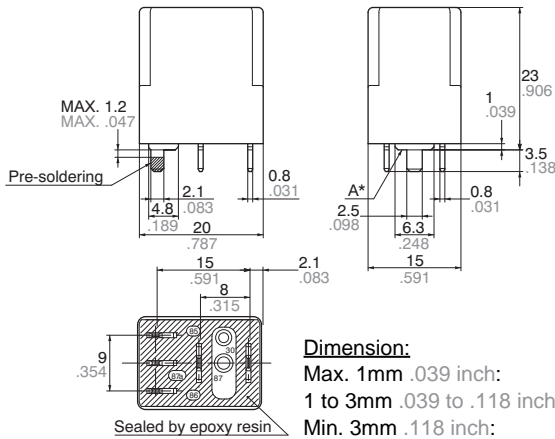

|                             |                          |
|-----------------------------|--------------------------|
| <b>Dimension:</b>           | <b>General tolerance</b> |
| Max. 1mm .039 inch:         | $\pm 0.1 \pm 0.04$       |
| 1 to 3mm .039 to .118 inch: | $\pm 0.2 \pm 0.08$       |
| Min. 3mm .118 inch:         | $\pm 0.3 \pm 0.12$       |

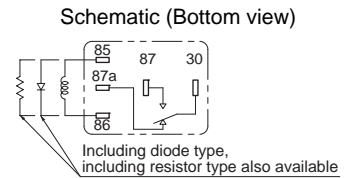

 diode type

PC board pattern (Bottom view)



\* Dimensions (thickness and width) of terminal specified in this catalog is measured before pre-soldering. Intervals between terminals is measured at A surface level.

**4. Micro-ISO PC board type (1 Form A)**

**CAD Data**

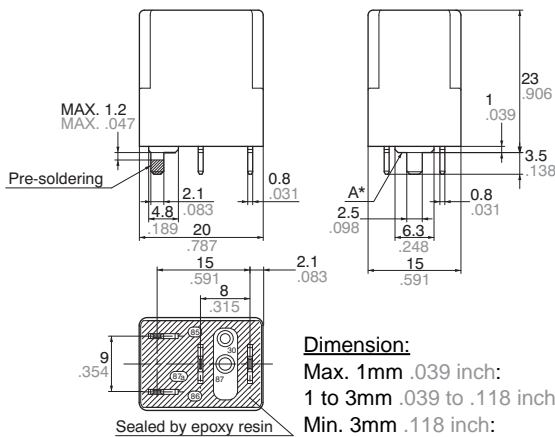

|                             |                          |
|-----------------------------|--------------------------|
| <b>Dimension:</b>           | <b>General tolerance</b> |
| Max. 1mm .039 inch:         | $\pm 0.1 \pm 0.04$       |
| 1 to 3mm .039 to .118 inch: | $\pm 0.2 \pm 0.08$       |
| Min. 3mm .118 inch:         | $\pm 0.3 \pm 0.12$       |

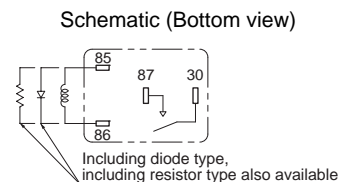

 diode type

\* Dimensions (thickness and width) of terminal specified in this catalog is measured before pre-soldering. Intervals between terminals is measured at A surface level.

**REFERENCE DATA**

1-(1). Coil temperature rise (12V type)

Sample: CM1F-12V, 3 pcs.  
 Measured portion: Inside the coil  
 Contact carrying current: 20A, 35A  
 Ambient temperature: 85°C 185°F



1-(2). Coil temperature rise (24V type)

Sample: CM1F-24V, 4 pcs.  
 Measured portion: Inside the coil  
 Contact carrying current: 0A, 15A  
 Ambient temperature: 85°C 185°F

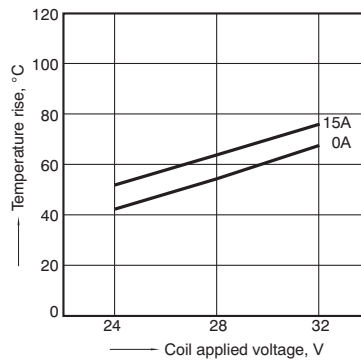

2. Max. switching capability (Resistive load, initial)



3. Ambient temperature and operating temperature range (12V type)

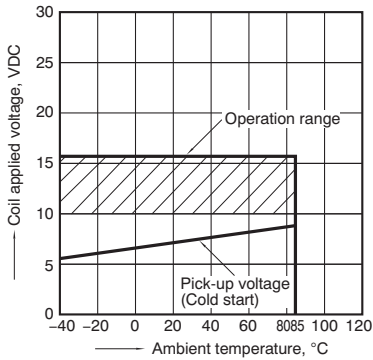

4. Ambient temperature characteristics (Cold/initial)

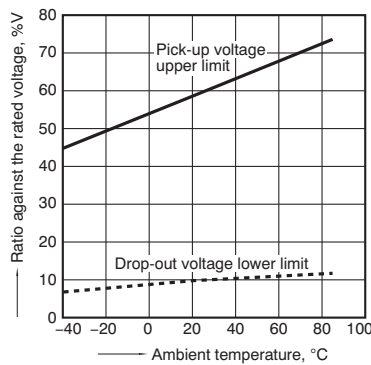

5. Distribution of pick-up and drop-out voltage  
 Sample: CM1F-12V, 100pcs.

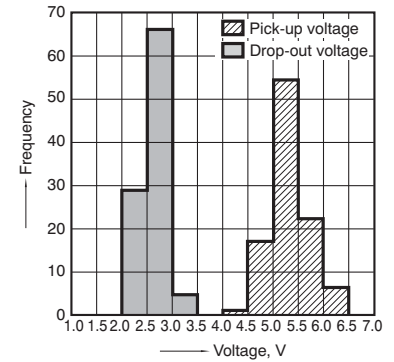

6. Distribution of operate time

Sample: CM1F-12V, 30pcs.  
 \* Max. 10ms standard (excluding contact bounce)



7. Distribution of release time

Sample: CM1F-12V, 30pcs.  
 \* Max. 10ms standard (excluding contact bounce)  
 Without diode



Products with diode inside  are discontinued in 2014.

8-(1). Electrical life test (Motor free)  
 Sample: CM1aF-R-12V, 6pcs.  
 Load: 16 A 13.5 V DC  
 Cooling fan motor actual load (free condition)  
 Switching frequency: (ON:OFF = 2s:6s)  
 Ambient temperature: Room temperature

Circuit



Change of pick-up and drop-out voltage

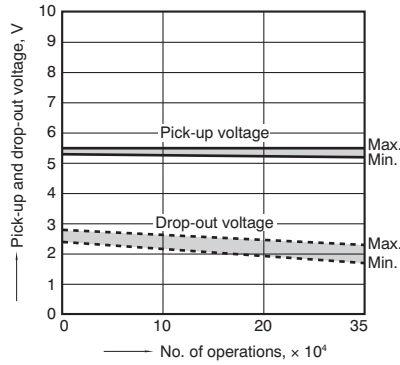

Change of contact resistance

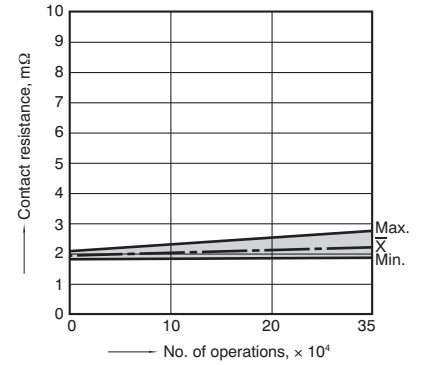

Load current waveform  
 Inrush current: 85A, Steady current: 18A,

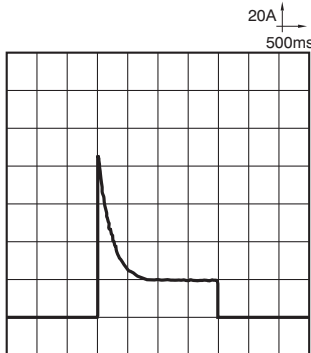

8-(2). Electrical life test (Halogen lamp load)

Sample: CM1aF-R-12V, 6pcs.  
 Load: 20A 13.5V DC  
 Switching frequency: (ON:OFF = 1s:14s)  
 Ambient temperature: Room temperature

Change of pick-up and drop-out voltage



Change of contact resistance

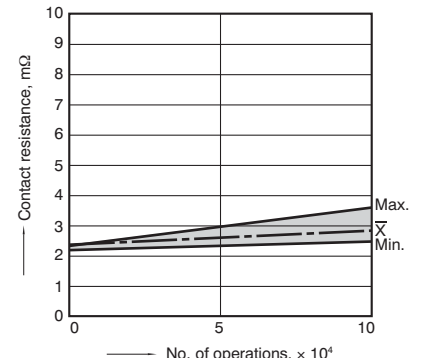

## Cautions regarding the protection element

### 1. Part numbers without protection elements

1) 12 V models

When connecting a coil surge protection circuit to these relays, we recommend a Zener diode with a Zener voltage of 24 V or higher, or a resistor (680Ω to 1,000Ω). When a diode is connected to the coil in parallel, the release time will slow down and working life may shorten. Before use, please check the circuit and verify that the diode is not connected in parallel to the coil drive circuit.

2) 24 V models

When connecting a coil surge protection

circuit to these relays, we recommend a Zener diode with a Zener voltage of 48 V or higher, or a resistor (2,800Ω to 4,700Ω).

When a diode is connected to the coil in parallel, the release time will slow down and working life may shorten. Before use, please check the circuit and verify that the diode is not connected in parallel to the coil drive circuit.

### 2. Part numbers with diodes

These relays use a diode in the coil surge protection element. Therefore, the release time is slower and the working life might be shorter compared to part

numbers without protection elements and part numbers with resistors.

Be sure to use only after evaluating under actual load conditions.

### 3. Part numbers with resistors

This part number employs a resistor in the coil surge protection circuit; therefore, an external surge protection element is not required. In particular, when a diode is connected in parallel with a coil, the revert time becomes slower which could adversely affect working life. Please check the circuit and make sure that a diode is not connected in parallel with the coil drive circuit.

For Cautions for Use, see [Relay Technical Information](#).