

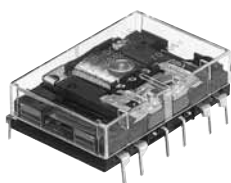

### Transistor drive 2c/4c 5A slim power relays

## NC RELAYS



NC4 Flat type  
(PC board type)

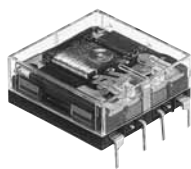

NC2 Flat type  
(PC board type)

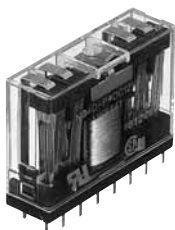

NC4 Slim type  
(Plug-in type)



NC2 Slim type  
(PC board type)

RoHS compliant

### FEATURES

#### 1. Compact, slim design

Use of high-performance flat electromagnetic design achieves 10.9 mm .429 inch profile, flat type thin package. Slim type, with width of 11.2 mm .441 inch, enables high-density mounting on PC boards.

#### 2. High reliability

Provides stable contact pressure needed for card lift-off contact driver method. The use of Ac clad twin contacts provides stable contact resistance and ensures high contact reliability.

#### 3. Compatible with all major safety standards

UL and CSA certified, and complies with Japanese Electrical Appliance and Material Control Law.

#### 4. Socket and terminal are available

### TYPICAL APPLICATIONS

1. Gas hot air heating equipment and air conditioners
2. Timer and temperature controller
3. Facsimile machines and electronic counting devices
4. Machine tools, factory automation devices and NC machines

Protective construction: Dust cover type/  
Sealed type

### ORDERING INFORMATION

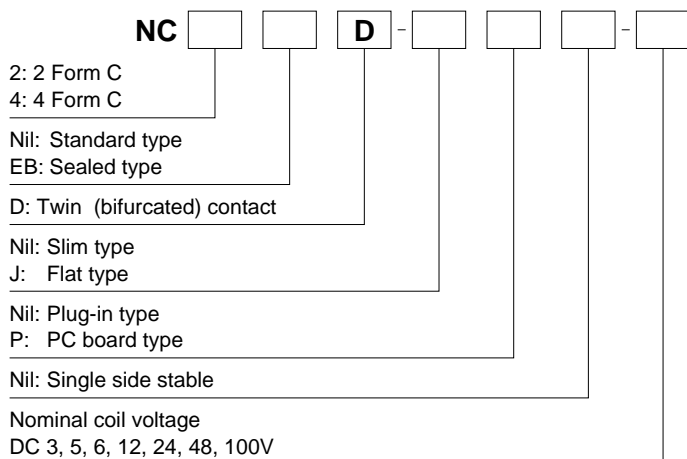

## TYPES

### 1. Standard type

#### 1) Flat type

Contact arrangement	Nominal coil voltage	PC board type	
		Part No.	
2 Form C	3V DC	NC2D-JP-DC3V	
	5V DC	NC2D-JP-DC5V	
	6V DC	NC2D-JP-DC6V	
	12V DC	NC2D-JP-DC12V	
	24V DC	NC2D-JP-DC24V	
	48V DC	NC2D-JP-DC48V	
	100V DC	NC2D-JP-DC100V	
4 Form C	3V DC	NC4D-JP-DC3V	
	5V DC	NC4D-JP-DC5V	
	6V DC	NC4D-JP-DC6V	
	12V DC	NC4D-JP-DC12V	
	24V DC	NC4D-JP-DC24V	
	48V DC	NC4D-JP-DC48V	
	100V DC	NC4D-JP-DC100V	

Standard packing: Carton: 20 pcs.; Case: 200 pcs.

#### 2) Slim type

Contact arrangement	Nominal coil voltage	Plug-in type	PC board type
		Part No.	Part No.
2 Form C	3V DC	NC2D-DC3V	NC2D-P-DC3V
	5V DC	NC2D-DC5V	NC2D-P-DC5V
	6V DC	NC2D-DC6V	NC2D-P-DC6V
	12V DC	NC2D-DC12V	NC2D-P-DC12V
	24V DC	NC2D-DC24V	NC2D-P-DC24V
	48V DC	NC2D-DC48V	NC2D-P-DC48V
	100V DC	NC2D-DC100V	NC2D-P-DC100V
4 Form C	3V DC	NC4D-DC3V	NC4D-P-DC3V
	5V DC	NC4D-DC5V	NC4D-P-DC5V
	6V DC	NC4D-DC6V	NC4D-P-DC6V
	12V DC	NC4D-DC12V	NC4D-P-DC12V
	24V DC	NC4D-DC24V	NC4D-P-DC24V
	48V DC	NC4D-DC48V	NC4D-P-DC48V
	100V DC	NC4D-DC100V	NC4D-P-DC100V

Standard packing: Carton: 20 pcs.; Case: 200 pcs.

### 2. Sealed type

#### 1) Flat type

Contact arrangement	Nominal coil voltage	PC board type	
		Part No.	
2 Form C	3V DC	NC2EBD-JP-DC3V	
	5V DC	NC2EBD-JP-DC5V	
	6V DC	NC2EBD-JP-DC6V	
	12V DC	NC2EBD-JP-DC12V	
	24V DC	NC2EBD-JP-DC24V	
	48V DC	NC2EBD-JP-DC48V	
	100V DC	NC2EBD-JP-DC100V	
4 Form C	3V DC	NC4EBD-JP-DC3V	
	5V DC	NC4EBD-JP-DC5V	
	6V DC	NC4EBD-JP-DC6V	
	12V DC	NC4EBD-JP-DC12V	
	24V DC	NC4EBD-JP-DC24V	
	48V DC	NC4EBD-JP-DC48V	
	100V DC	NC4EBD-JP-DC100V	

Standard packing: Carton: 20 pcs.; Case: 200 pcs.

2) Slim type

Contact arrangement	Nominal coil voltage	Plug-in type	PC board type
		Part No.	Part No.
2 Form C	3V DC	NC2EBD-DC3V	NC2EBD-P-DC3V
	5V DC	NC2EBD-DC5V	NC2EBD-P-DC5V
	6V DC	NC2EBD-DC6V	NC2EBD-P-DC6V
	12V DC	NC2EBD-DC12V	NC2EBD-P-DC12V
	24V DC	NC2EBD-DC24V	NC2EBD-P-DC24V
	48V DC	NC2EBD-DC48V	NC2EBD-P-DC48V
	100V DC	NC2EBD-DC100V	NC2EBD-P-DC100V
4 Form C	3V DC	NC4EBD-DC3V	NC4EBD-P-DC3V
	5V DC	NC4EBD-DC5V	NC4EBD-P-DC5V
	6V DC	NC4EBD-DC6V	NC4EBD-P-DC6V
	12V DC	NC4EBD-DC12V	NC4EBD-P-DC12V
	24V DC	NC4EBD-DC24V	NC4EBD-P-DC24V
	48V DC	NC4EBD-DC48V	NC4EBD-P-DC48V
	100V DC	NC4EBD-DC100V	NC4EBD-P-DC100V

Standard packing: Carton: 20 pcs.; Case: 200 pcs.

\* Sockets and terminal sockets available.

**RATING**

**1. Coil data**

Single side stable

No. of poles	Nominal coil voltage	Pick-up voltage (at 20°C 68°F)	Drop-out voltage (at 20°C 68°F)	Nominal operating current [±10%] (at 20°C 68°F)	Coil resistance [±10%] (at 20°C 68°F)	Nominal operating power	Coil inductance		Max. applied voltage (at 50°C 122°F)*
							N.C. condition	N.O. condition	
2 Form C	3V DC	80%V or less of nominal voltage (Initial)	10%V or more of nominal voltage (Initial)	120mA	25Ω	360mW	24.2mH	30.0mH	135%V of nominal voltage
	5V DC			72mA	69.4Ω	360mW	69.5mH	86.0mH	
	6V DC			60mA	100Ω	360mW	99.4mH	123mH	
	12V DC			30mA	400Ω	360mW	388mH	480mH	
	24V DC			15mA	1,600Ω	360mW	1,590mH	1,970mH	
	48V DC			7.5mA	6,400Ω	360mW	6,270mH	7,680mH	
	100V DC			7.4mA	13,500Ω	740mW	9,470mH	11,700mH	110%V of nominal voltage
4 Form C	3V DC	80%V or less of nominal voltage (Initial)	10%V or more of nominal voltage (Initial)	240mA	12.5Ω	720mW	12.8mH	15.8mH	110%V of nominal voltage
	5V DC			144mA	34.7Ω	720mW	34.3mH	42.4mH	
	6V DC			120mA	50Ω	720mW	50.7mH	62.7mH	
	12V DC			60mA	200Ω	720mW	203mH	252mH	
	24V DC			30mA	800Ω	720mW	812mH	1,000mH	
	48V DC			15mA	3,200Ω	720mW	2,820mH	3,480mH	
	100V DC			7.4mA	13,500Ω	740mW	14,100mH	17,400mH	

\* At 20°C 68°F (Sealed type)

## 2. Specifications

Characteristics	Item	Specifications	
Contact	Arrangement	2 Form C	4 Form C
	Contact resistance (Initial)	Max. 50 mΩ (By voltage drop 6 V DC 1A)	Max. 50 mΩ (By voltage drop 6 V DC 1A)
	Contact material	Au-clad AgNi type	Au-clad AgNi type
Rating	Nominal switching capacity (resistive load)	Standard: 5A 250V AC, 5A 30V DC Sealed: 3A 250V AC, 5A 30V DC	Standard: 4A 250V AC, 5A 30V DC Sealed: 2A 250V AC, 5A 30V DC
	Max. switching power (resistive load)	Standard: 1,250VA, 150W Sealed: 750VA, 150W	Standard: 1,000VA, 150W Sealed: 500VA, 150W
	Max. switching voltage	250 V AC	
	Max. switching current	Standard: 5A Sealed: 3A (AC), 5A (DC)	Standard: 4A Sealed: 2A (AC), 5A (DC)
	Nominal operating power	360mW (740mW: 100V DC)	720mW*2
	Min. switching capacity (Reference value)*1	100μA 1V DC	100μA 1VDC
	Insulation resistance (Initial)	Min. 100MΩ (at 500V DC) Measurement at same location as "Breakdown voltage" section.	
Electrical characteristics	Breakdown voltage (Initial)	Between open contacts	1,000 Vrms for 1min. (Detection current: 10mA.)
		Between contact sets	1,000 Vrms for 1min. (Detection current: 10mA.)
		Between contact and coil	2,000 Vrms for 1min. (Detection current: 10mA.)
	Temperature rise (coil)	Max. 65°C [Max. 85°C (100V AC)] (By resistive method, nominal coil voltage)	
	Operate time (at 20°C 68°F)	Max. 20ms	Max. 20ms
	Release time (at 20°C 68°F)	Max. 10ms	Max. 10ms
Mechanical characteristics	Shock resistance	Functional	Min. 98 m/s <sup>2</sup> (Half-wave pulse of sine wave: 11 ms; detection time: 10μs.)
		Destructive	Min. 980 m/s <sup>2</sup> (Half-wave pulse of sine wave: 6 ms.)
	Vibration resistance	Functional	10 to 55 Hz at double amplitude of 1 mm (Detection time: 10μs.)
		Destructive	10 to 55 Hz at double amplitude of 2 mm
Expected life	Mechanical	Min. 5×10 <sup>7</sup>	Min. 5×10 <sup>7</sup>
	Electrical (resistive load)	Standard: Min. 10 <sup>5</sup> (5A 250V AC), Min. 5×10 <sup>5</sup> (5A 30V DC) Sealed: Min. 10 <sup>5</sup> (3A 250V AC), Min. 5×10 <sup>5</sup> (5A 30V DC)	Standard: Min. 10 <sup>5</sup> (4A 250V AC), Min. 5×10 <sup>5</sup> (5A 30V DC) Sealed: Min. 10 <sup>5</sup> (2A 250V AC), Min. 5×10 <sup>5</sup> (5A 30V DC)
Conditions	Conditions for operation, transport and storage*3 (Not freezing and condensing at low temperature)	-40°C to +70°C -40°F to +158°F (Max.48V DC), -40°C to +55°C -40°F to +131°F (100V DC)	-40°C to +55°C -40°F to +131°F
	Max. Operating speed	50 cps	
Unit weight		16 g .56 oz	18 g .63 oz

Notes: \*1 This value can change due to the switching frequency, environmental conditions, and desired reliability level, therefore it is recommended to check this with the actual load.

\*2. 100V DC: 740mW

\*3. The upper limit of the ambient temperature is the maximum temperature that can satisfy the coil temperature rise value. Refer to Usage, transport and storage conditions in NOTES.

# REFERENCE DATA (Standard type)

1.-(1) Life curve (2 Form C, 4 Form C)

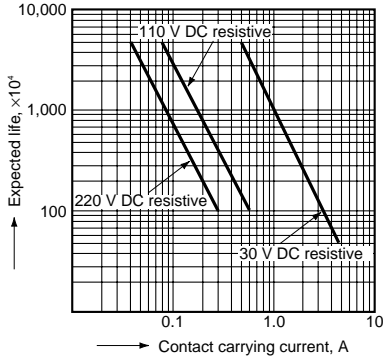

1.-(2) Life curve (2 Form C)

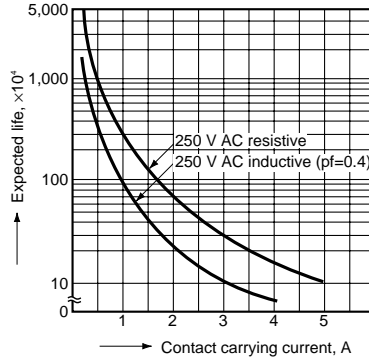

1.-(3) Life curve (4 Form C)

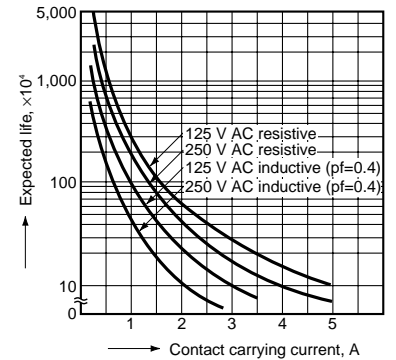

2. Temperature rise characteristics (single side stable)

Measured portion: Inside the coil

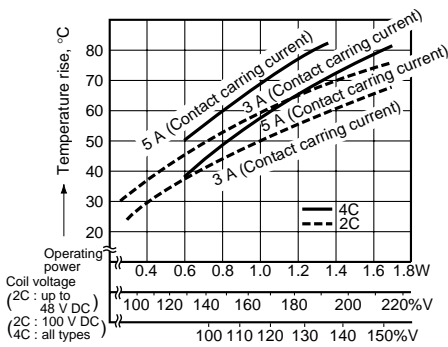

3. Operate time (single side stable)

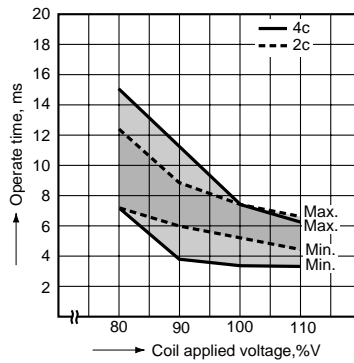

4. Release time (single side stable)

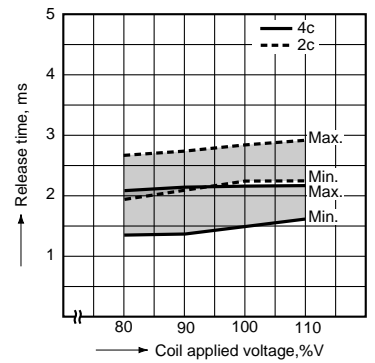

5.-(1) Rate of change of pick-up and drop-out voltage (2 Form C single side stable)

(2 Form C single side stable)

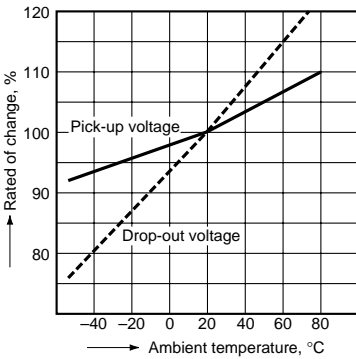

5.-(2) Rate of change of pick-up and drop-out voltage (4 Form C single side stable)

(4 Form C single side stable)

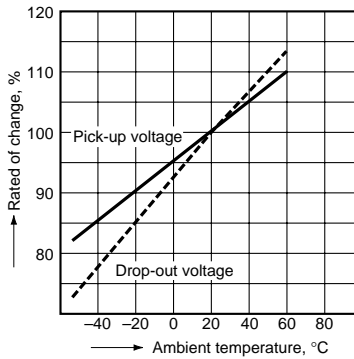

6.-(1) Ambient temperature vs Max. applied voltage

Tested sample: NC2D-P-DC24 V (2 Form C slim single side stable)

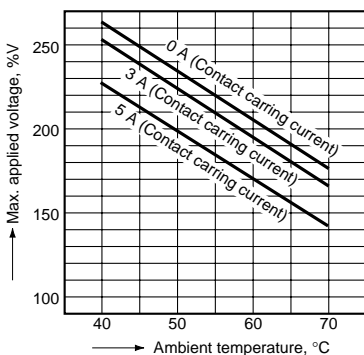

6.-(2) Ambient temperature vs Max. applied voltage

Tested sample: NC2D-P-DC110 V (2 Form C slim single side stable), NC4D-P-DC24 V (4 Form C slim single side stable)

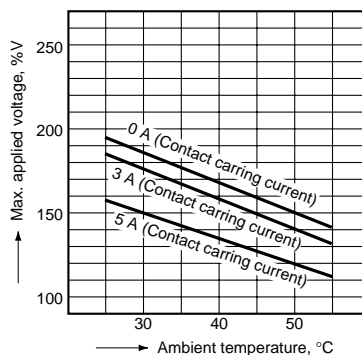

**DIMENSIONS** (mm inch)

The CAD data of the products with a **CAD Data** mark can be downloaded from: <http://industrial.panasonic.com/ac/e/>

<Standard type>

Flat type  
2 Form C

**CAD Data**



External dimensions

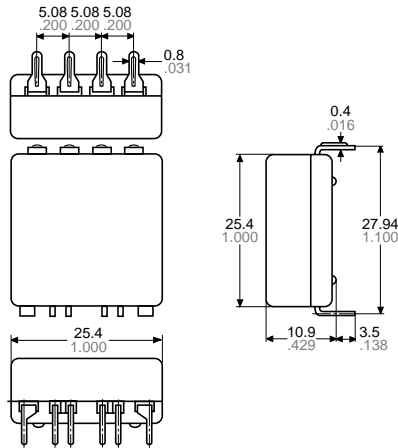

Schematic (Top view)  
Single side stable

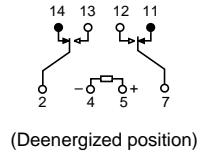

PC board pattern (Bottom view)  
Single side stable

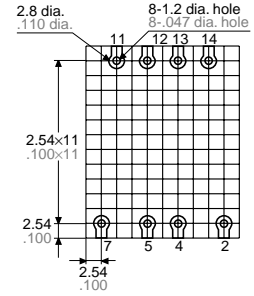

Flat type  
4 Form C

**CAD Data**

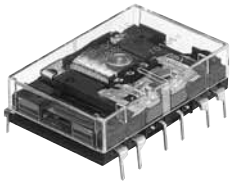

External dimensions

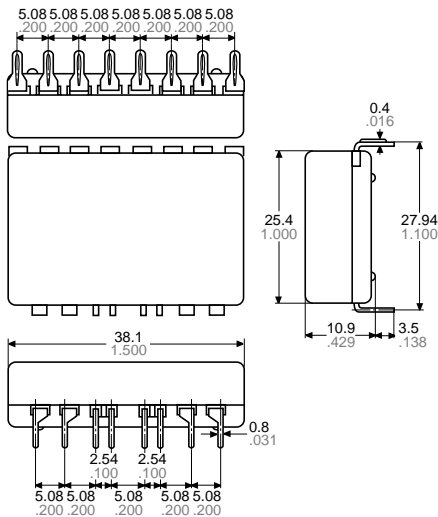

Schematic (Top view)  
Single side stable

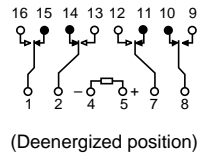

PC board pattern (Bottom view)  
Single side stable

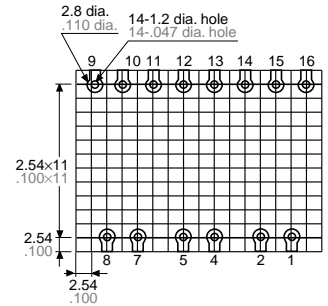

Slim type  
Plug-in type  
2 Form C

**CAD Data**



External dimensions

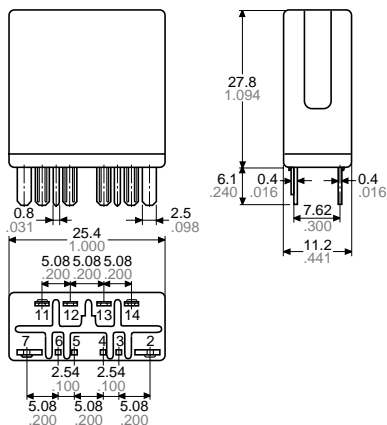

Schematic (Bottom view)  
Single side stable

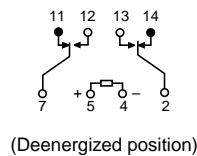

Slim type  
Plug-in type  
4 Form C

**CAD Data**



External dimensions

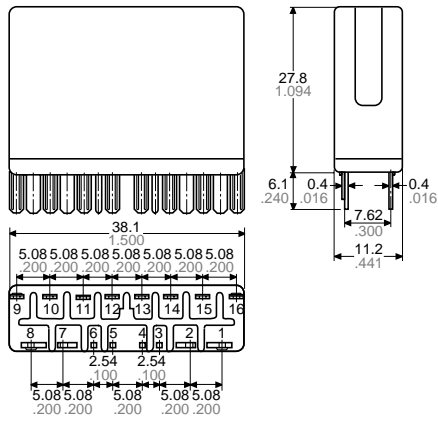

Schematic (Bottom view)  
Single side stable

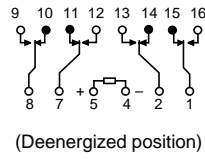

Slim type  
PC board type  
2 Form C

**CAD Data**



External dimensions

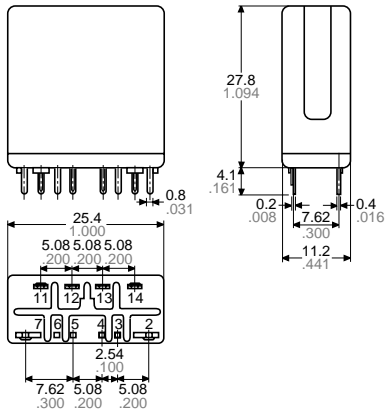

(Dowel heigh: 0.4 .016)

Schematic (Bottom view)  
Single side stable

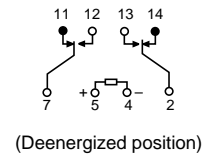

PC board pattern (Bottom view)  
Single side stable

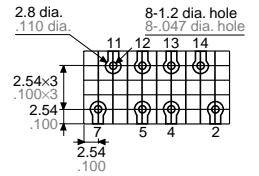

Slim type  
PC board type  
4 Form C

**CAD Data**

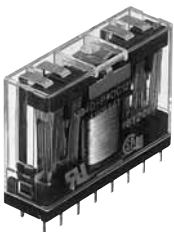

External dimensions

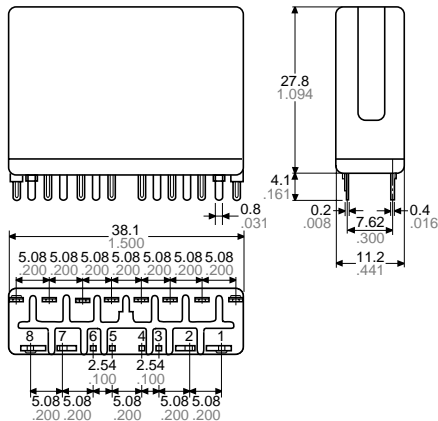

(Dowel heigh: 0.4 .016)

Schematic (Bottom view)  
Single side stable

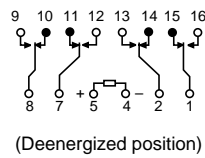

PC board pattern (Bottom view)  
Single side stable

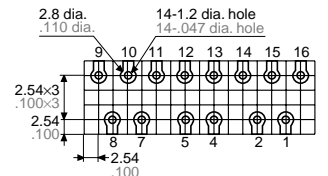

<Sealed type>

Flat type  
PC board type  
2 Form C

**CAD Data**



External dimensions

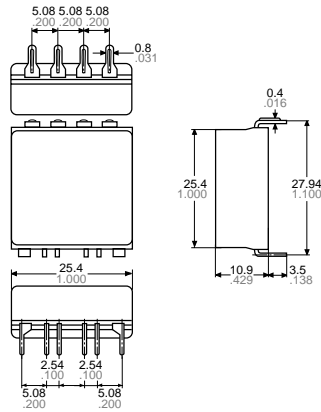

Schematic (Top view)

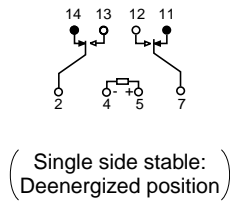

PC board pattern (Bottom view)

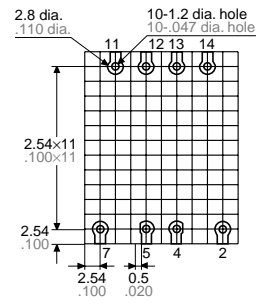

Flat type  
PC board type  
4 Form C

**CAD Data**



External dimensions

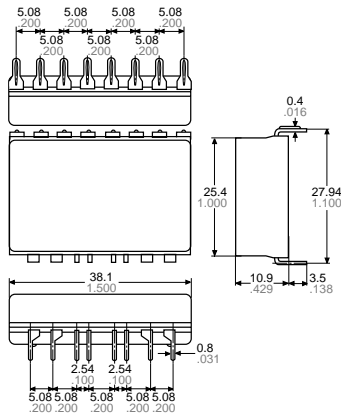

Schematic (Top view)

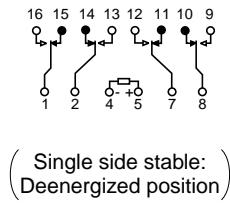

PC board pattern (Bottom view)

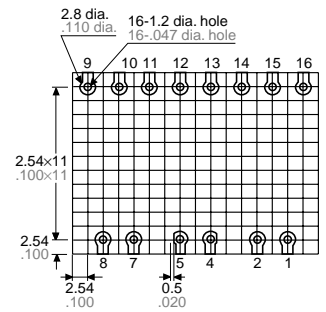

Slim type  
Plug-in type  
2 Form C

**CAD Data**



External dimensions

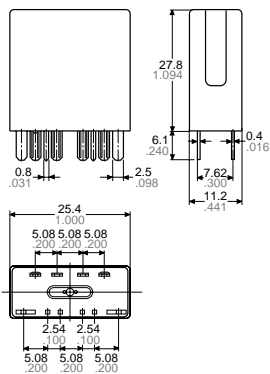

Schematic (Bottom view)

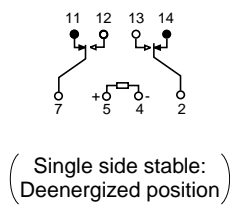



Slim type  
Plug-in type  
4 Form C

**CAD Data**



External dimensions

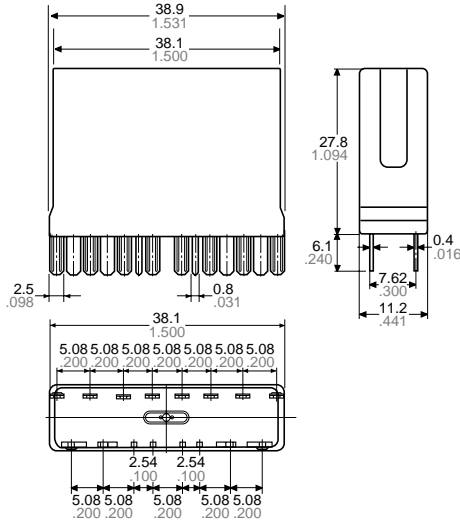

Schematic (Bottom view)

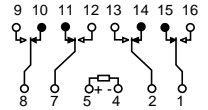

(Single side stable:  
Deenergized position)

Slim type  
PC board type  
2 Form C

**CAD Data**



External dimensions

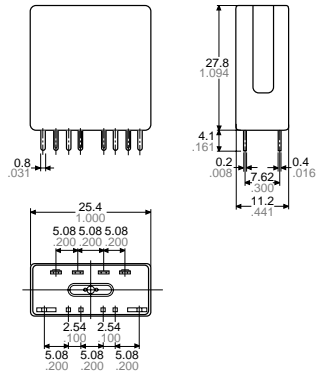

Schematic (Bottom view)

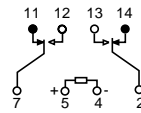

(Single side stable:  
Deenergized position)

PC board pattern (Bottom view)

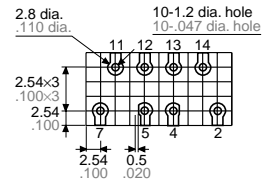

Slim type  
PC board type  
4 Form C

**CAD Data**



External dimensions

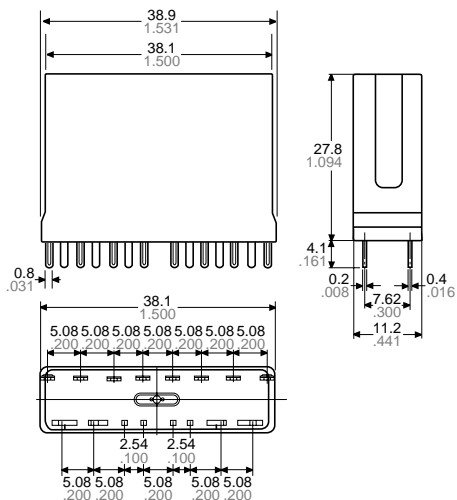

Schematic (Bottom view)

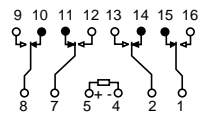

(Single side stable:  
Deenergized position)

PC board pattern (Bottom view)

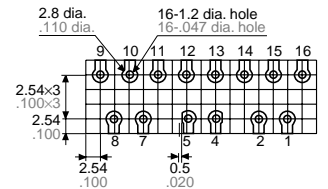

# SAFETY STANDARDS

Product name		UL/C-UL (Recognized)		CSA (Certified)	
		File No.	Contact rating	File No.	Contact rating
NC	2 Form C	E43028	5A 250V AC 1/10HP 125, 250V AC 5A 30V DC	LR26550 etc.	5A 250V AC 1/10HP 125, 250V AC 5A 30V DC
	4 Form C	E43028	5A 125V AC 4A 250V AC 1/10HP 125, 250V AC 5A 30V DC	LR26550 etc.	5A 125V AC 4A 250V AC 1/10HP 125, 250V AC 5A 30V DC
NC Sealed	2 Form C	E43028	3A 250V AC 1/20HP 125, 250V AC 5A 30V DC	LR26550 etc.	3A 250V AC 1/20HP 125, 250V AC 5A 30V DC
	4 Form C	E43028	2A 250V AC 1/20HP 125, 250V AC 5A 30V DC	LR26550 etc.	2A 250V AC 1/20HP 125, 250V AC 5A 30V DC

## NOTES

1. For cautions for use, please read "GENERAL APPLICATION GUIDELINES" on page B-1.
2. Because the NC relay is polarized, the positive "+" and negative "-" connections to the coil should be done as indicated on the wiring diagram. If connected incorrectly, it may malfunction or fail to operate.
3. While NC relays can be used with any transmission-wave current to their operation, due to slight weakening of the force of magnetic attraction, decreased resistance to vibration and shock should be taken into account.

4. When designing top and bottom view schematic diagrams, note that:
  - 1) "Top view" wiring diagram is indicated for the flat series because terminals can be seen from above.
  - 2) "Bottom view" schematic diagram is indicated for the vertical series because terminals cannot be seen from above.

5. Cautions for close proximity mounting  
When using slim series in close proximity, mount all relays facing the same direction. Different mounting directions may cause change in the relay characteristics because NC relays are polarized.

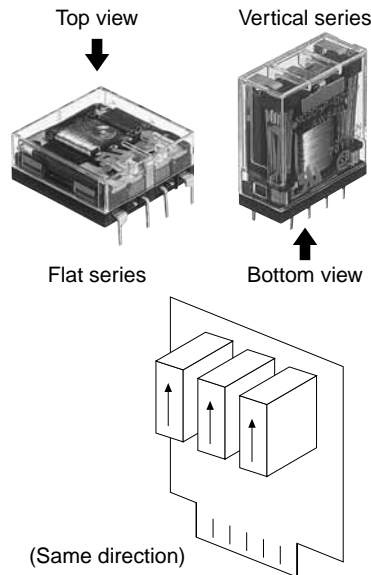

# ACCESSORIES

## NC RELAYS (sockets and terminal sockets)

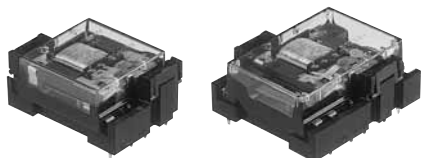

NC2 Flat type socket

NC4 Flat type socket

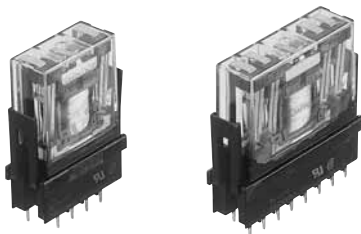

NC2 Slim type socket

NC4 Slim type socket



NC2 DIN terminal socket

### FEATURES

#### • Socket

1) The vertical (slim) type with solder terminals has a retainer, which enables snap-in fixing on chassis, panels, and similar locations. Because the sockets for both solder terminals and PC boards firmly fix the relay at the time of insertion, once snapped in, spring clips are unnecessary.

2) For the flat type, pull up the hinged clasps in the direction of the arrows shown in the drawing after inserting the relay.

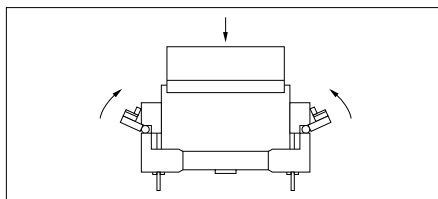

**RoHS compliant**

### TYPES

	Product name	Terminals	Part No.
Flat type socket	NC2-flat type PC board socket	P/C board	NC2-JPS
	NC4-flat type PC board socket	P/C board	NC4-JPS
Slim type terminal socket	NC2-DIN terminal socket	DIN rail	NC2-SFD
Slim type socket	NC2-slim type socket	Solder	NC2-SS
	NC2-slim type PC board socket	P/C board	NC2-PS
	NC2-slim type wrapping socket	Lead wire	NC2-WS
	NC4-slim type socket	Solder	NC4-SS
	NC4-slim type PC board socket	P/C board	NC4-PS
	NC4-slim type wrapping socket	Lead wire	NC4-WS

### SPECIFICATIONS (common)

Item	Specifications
Max. continuous current	Slim type: 5A 250V AC, Flat type: 5A 250V AC
Initial breakdown voltage	2,000 V AC (Except for coil to coil of L2 type: 1,500 V AC)
Initial insulation resistance	Min. 100MΩ (at 500V DC megger)
Heat resistance	150°C 302°F for 1 hour

Note: Do not insert or remove relays while in the energized condition.

# NC Relay Sockets and DIN terminal sockets

## DIMENSIONS (mm inch)

The CAD data of the products with a **CAD Data** mark can be downloaded from: <http://industrial.panasonic.com/ac/e/>

### Flat type socket for PC board NC2-JPS

**CAD Data**

#### External dimensions

#### Terminal portion

#### PC board pattern

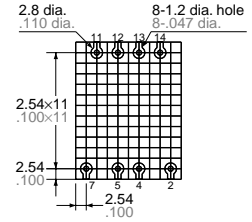
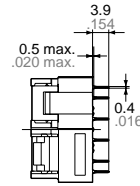
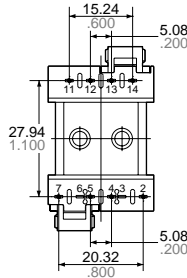
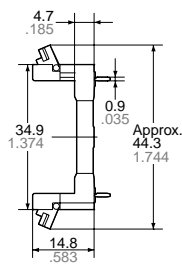
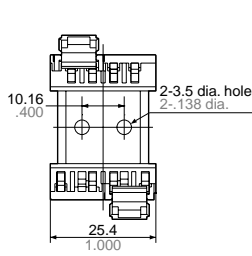

### Flat type socket for PC board NC4-JPS

**CAD Data**

#### External dimensions

#### Terminal portion

#### PC board pattern

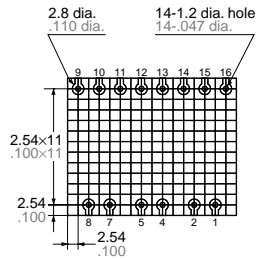
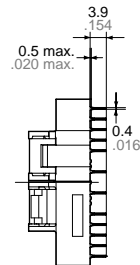
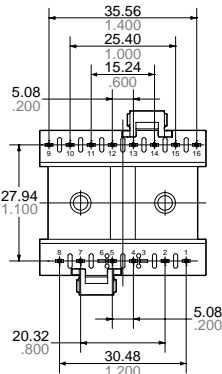
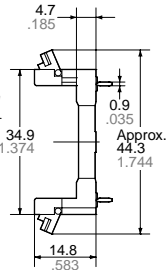
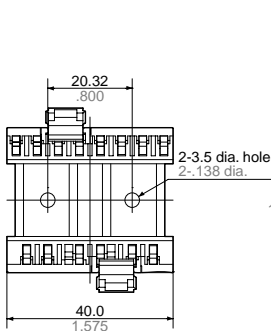

### Slim type DIN terminal socket NC2-SFD

**CAD Data**

#### External dimensions

#### Mounting hole diagram

#### Schematic

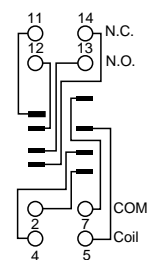
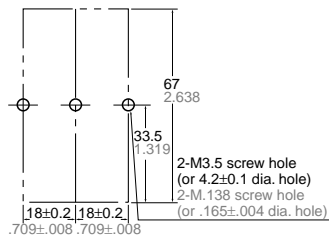
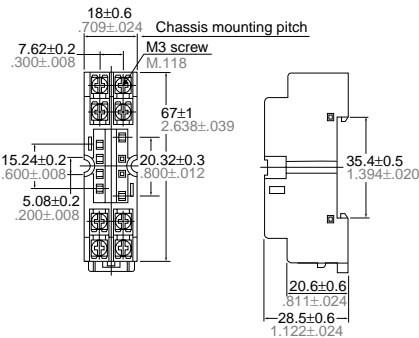
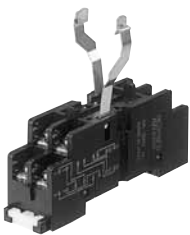

(Retaining springs are included with the DIN terminal socket.)

\*To prevent damage or distortion, when tightening fixing screws, the optimum torque range should be 0.49 to 0.69 N·m, (5 to 7 kgf·cm).

## Slim type socket for solder terminal NC2-SS

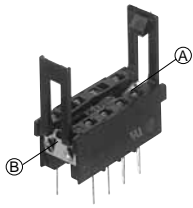

### CAD Data

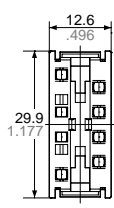

### External dimensions

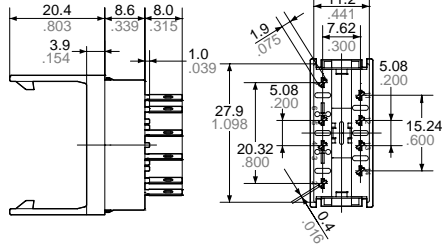

### Chassis cutout

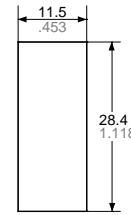

- Notes: 1. Suitable chassis thickness is 1.0 to 2.0 mm .039 to .079 inch.  
2. Once the socket is inserted from above into the mounting holes, the relay will snap in to clips rising from either side at (A) and (B) by pushing.

## Slim type socket for solder terminal NC4-SS

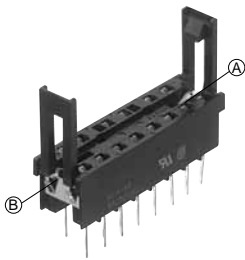

### CAD Data

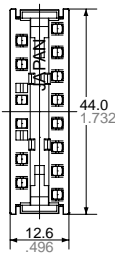

### External dimensions

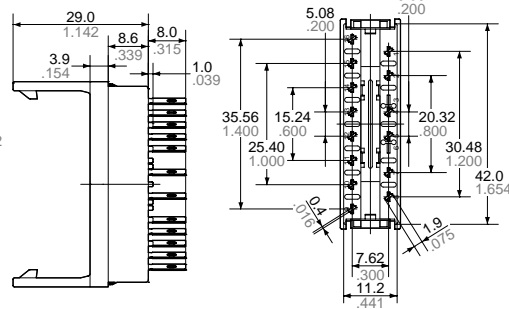

### Chassis cutout

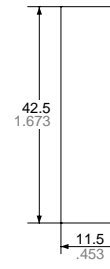

- Notes: 1. Suitable chassis thickness is 1.0 to 2.0 mm .039 to .079 inch.  
2. Once the socket is inserted from above into the mounting holes, the relay will snap in to clips rising from either side at (A) and (B) by pushing.

## Slim type socket for PC board NC2-PS



### CAD Data

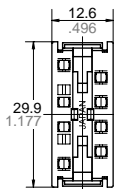

### External dimensions

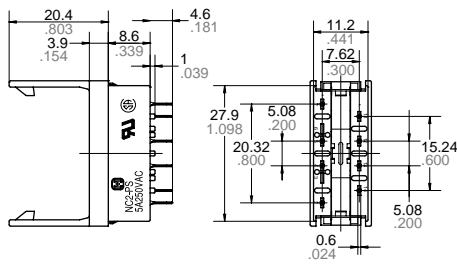

### PC board pattern

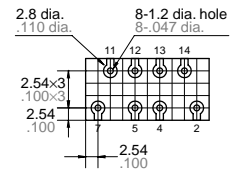

## Slim type socket for PC board NC4-PS



### CAD Data

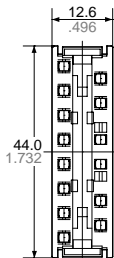

### External dimensions

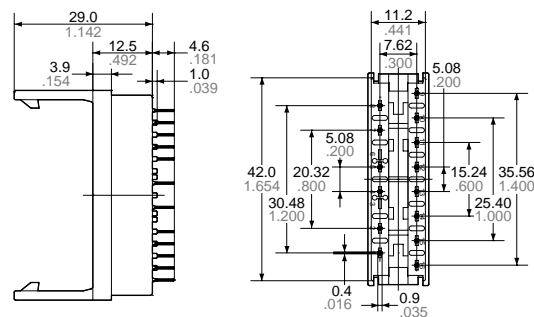

### PC board pattern

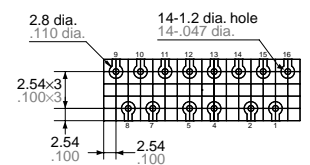

# NC Relay Sockets and DIN terminal sockets

## Vertical (Slim) type wrapping socket NC2-WS



### CAD Data

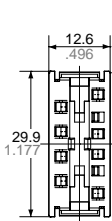

### External dimensions

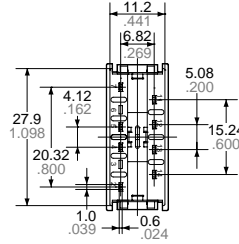
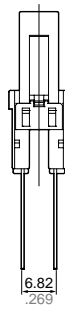
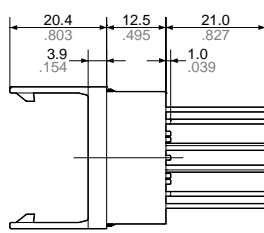

### Terminal cross section

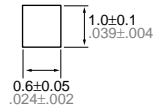

### Chassis cutout

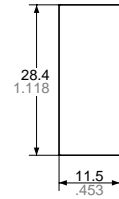

## Vertical (Slim) type wrapping socket NC4-WS



### CAD Data

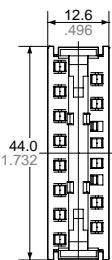

### External dimensions

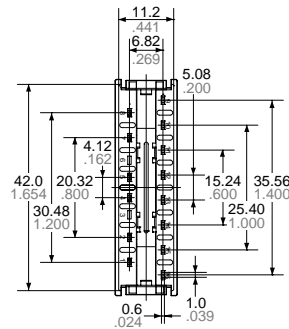
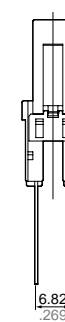
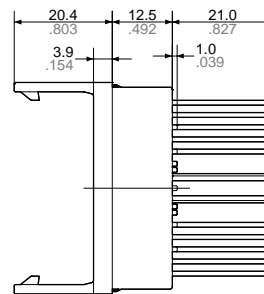

### Chassis cutout

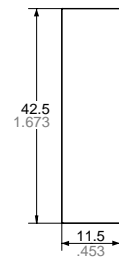

## NOTES

1. Soldering should be done quickly to avoid damaging the thermoplastic body.
2. For solder terminal types, connect terminals as shown in the diagram at right to maintain insulation distance.

