



Compact Relay Family with Forcibly Guided Contacts

SF-Y RELAYS



4-pole
(2 Form A 2 Form B, 3 Form A 1 Form B)



6-pole
(4 Form A 2 Form B, 5 Form A 1 Form B)

RoHS compliant

FEATURES

- Forcibly guided contact structure**
Relay complies with EN 50205, Type A
Equipped with forcibly guided contact structure that enables detection of contact welding and construction of safety circuit.
- Small size**
- Different contact configurations:**

| Type | L × W × H (mm inch) |
|-----------------------------------------|--------------------------------------------|
| 2 Form A 2 Form B, 3 Form A 1 Form B | 31.0 × 28.6 × 14.5 1.220 × 1.126 × .571 |
| 4 Form A 2 Form B, 5 Form A 1 Form B | 39.0 × 28.6 × 14.5 1.535 × 1.126 × .571 |

- Low profile: 14.5 mm .571 inch**
- Insulation according to EN 60664-1:**
Overvoltage category III, Pollution degree 2, 250V AC
 - Reinforced insulation:**
Clearance and creepage 5.5 mm .217 inch
(between all contacts and between contact NO4 and coil)
 - Basic insulation:**
Clearance 3 mm .118 inch and creepage 4 mm .157 inch
(between all contacts and between contact NC3 and coil)

TYPICAL APPLICATIONS

- Emergency stop switches
- Machine safety engineering
- Safety control units
- Automation technology
- Elevators
- Escalators
- Overcurrent protection with monitor contact

ORDERING INFORMATION

Contact arrangement
2: 2 Form A 2 Form B
3: 3 Form A 1 Form B
4: 4 Form A 2 Form B
5: 5 Form A 1 Form B

Nominal coil voltage
DC 5, 12, 16, 18, 21, 24V

Notes: Please consult us about other coil voltages.
Gold-clad contact type available on request.

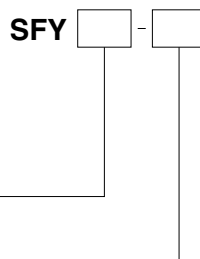

TYPES

| Contact arrangement | | Nominal coil voltage | Part No. |
|---------------------|-------------------|----------------------|------------|
| 4-pole | 2 Form A 2 Form B | 5 V DC | SFY2-DC5V |
| | | 12 V DC | SFY2-DC12V |
| | | 16 V DC | SFY2-DC16V |
| | | 18 V DC | SFY2-DC18V |
| | | 21 V DC | SFY2-DC21V |
| | | 24 V DC | SFY2-DC24V |
| | 3 Form A 1 Form B | 5 V DC | SFY3-DC5V |
| | | 12 V DC | SFY3-DC12V |
| | | 16 V DC | SFY3-DC16V |
| | | 18 V DC | SFY3-DC18V |
| 24 V DC | | SFY3-DC24V | |
| 6-pole | 4 Form A 2 Form B | 5 V DC | SFY4-DC5V |
| | | 12 V DC | SFY4-DC12V |
| | | 16 V DC | SFY4-DC16V |
| | | 18 V DC | SFY4-DC18V |
| | | 24 V DC | SFY4-DC24V |
| | 5 Form A 1 Form B | 5 V DC | SFY5-DC5V |
| | | 12 V DC | SFY5-DC12V |
| | | 16 V DC | SFY5-DC16V |
| | | 18 V DC | SFY5-DC18V |
| | | 24 V DC | SFY5-DC24V |

Standard packing: Tube 20 pcs.

RATING

1. Coil data

| Contact arrangement | | Nominal coil voltage | Pick-up voltage (at 20°C 68°F) | Drop-out voltage (at 20°C 68°F) | Nominal operating current [±10%] (at 20°C 68°F) | Coil resistance [±10%] (at 20°C 68°F) | Nominal operating power (at 20°C 68°F) | Max. applied voltage (at 20°C 68°F) |
|---------------------|-------------------|----------------------|-------------------------------------------|-------------------------------------------|-------------------------------------------------------|---------------------------------------------|-------------------------------------------|----------------------------------------|
| 4-pole | 2 Form A 2 Form B | 5V DC | 75%V or less of nominal voltage (Initial) | 15%V or more of nominal voltage (Initial) | 134mA | 38Ω | 670mW | 120%V of nominal voltage |
| | | 12V DC | | | 56mA | 215Ω | | |
| | | 16V DC | | | 42mA | 380Ω | | |
| | | 18V DC | | | 37mA | 483Ω | | |
| | | 21V DC | | | 32mA | 666Ω | | |
| | | 24V DC | | | 28mA | 864Ω | | |
| | 3 Form A 1 Form B | 5V DC | | | 134mA | 38Ω | | |
| | | 12V DC | | | 56mA | 215Ω | | |
| | | 16V DC | | | 42mA | 380Ω | | |
| | | 18V DC | | | 37mA | 483Ω | | |
| 24V DC | | 32mA | 666Ω | | | | | |
| 6-pole | 4 Form A 2 Form B | 5V DC | 134mA | 38Ω | | | | |
| | | 12V DC | 56mA | 215Ω | | | | |
| | | 16V DC | 42mA | 380Ω | | | | |
| | | 18V DC | 37mA | 483Ω | | | | |
| | | 24V DC | 32mA | 666Ω | | | | |
| | 5 Form A 1 Form B | 5V DC | 134mA | 38Ω | | | | |
| | | 12V DC | 56mA | 215Ω | | | | |
| | | 16V DC | 42mA | 380Ω | | | | |
| | | 18V DC | 37mA | 483Ω | | | | |
| | | 24V DC | 32mA | 666Ω | | | | |
| | | 24V DC | 28mA | 864Ω | | | | |

2. Specifications

| Characteristics | Item | Specifications | | |
|-----------------------------|-----------------------------------------------------------------------------------------------------|---------------------------------------------------------------------------------------------------------------------------------|----------------------------------------------------------------------------------|--|
| | | 4-pole | 6-pole | |
| Contact | Contact arrangement | 2 Form A 2 Form B, 3 Form A 1 Form B | 4 Form A 2 Form B, 5 Form A 1 Form B | |
| | Forcibly guided contacts | All contacts: Type A, EN 50205 | | |
| | Contact resistance (Initial) | Max. 100 mΩ (By voltage drop 6 V DC 1A) | | |
| | Contact material | Au-flashed AgNi alloy type | | |
| Rating | Nominal switching capacity (resistive load) | 6A 250V AC, 6A 30V DC | | |
| | Max. switching power (resistive load) | 1,500VA, 180W | | |
| | Max. switching voltage | 250V AC, 30V DC | | |
| | Max. switching current | 6 A | | |
| | Min. switching capacity (Reference value)*1 | 10mA 10V DC | | |
| Electrical characteristics | Insulation resistance (Initial) | Min. 1,000MΩ (at 500V DC) Measurement at same location as "Breakdown voltage" section. | | |
| | | Between open contacts | 1,500 Vrms for 1 min. (Detection current: 10mA) | |
| | | Between contact sets | 4,000 Vrms for 1 min. (Detection current: 10mA) | |
| | Breakdown voltage (Initial) | Between contact and coil | NC3: 2,500 Vrms for 1min; NO4: 4,000 Vrms for 1min (Detection current: 10mA) | |
| | | Coil holding voltage*4 | Min. 60%V (Initial, at 20°C 68°F) | |
| | Operate time (at 20°C 68°F) | Max. 20ms (Nominal coil voltage applied to the coil, excluding contact bounce time) | | |
| Release time (at 20°C 68°F) | Max. 10ms (Nominal coil voltage applied to the coil, excluding contact bounce time) (without diode) | | | |
| Mechanical characteristics | Shock resistance | Functional | 200 m/s ² (Half-wave pulse of sine wave: 11 ms; detection time: 10μs) | |
| | | Destructive | 1,000 m/s ² (Half-wave pulse of sine wave: 6 ms) | |
| | Vibration resistance | Functional | 10 to 55 Hz at double amplitude of 1.5 mm .059 inch (Detection time: 10μs) | |
| | | Destructive | 10 to 55 Hz at double amplitude of 1.5 mm .059 inch | |
| Expected life | Mechanical | Min. 10 ⁷ (at 180 times/min.) | | |
| | Electrical | 250 V AC 6 A resistive load: Min. 10 ⁵ (at 20 times/min.) | | |
| Degree of protection | RT III*3 | | | |
| Conditions | Conditions for operation, transport and storage*2 | Ambient temperature: -40°C to +70°C -40°F to +158°F Humidity: 5 to 85% R.H. (Not freezing and condensing at low temperature) | | |
| | Max. Operating speed | 20 times/min. (at nominal voltage) | | |
| Unit weight | Approx. 19 g .67 oz | | Approx. 23 g .81 oz | |

- Notes: *1. This value can change due to the switching frequency, environmental conditions, and desired reliability level, therefore it is recommended to check this with the actual load.
 *2. The upper limit of the ambient temperature is the maximum temperature that can satisfy the coil temperature rise value. Refer to Usage, transport and storage conditions in NOTES.
 *3. According to EN 61810-1:2010, table 2. Characteristic is sealed construction with terminals, case and base sealed shut with sealing resin. Construction is designed to prevent seeping of flux when soldering and cleaning fluid when cleaning. Harmful substances on the contacts are removed by gas purging before sealing with.
 *4. Coil holding voltage is the coil voltage after 100 ms from the applied nominal voltage.

Important: Relay characteristics may be influenced by:

- strong external magnetic fields
- magnetic conductive materials near the relay
- narrow top-to-top mounting (printed surface to printed surface)

Insulation

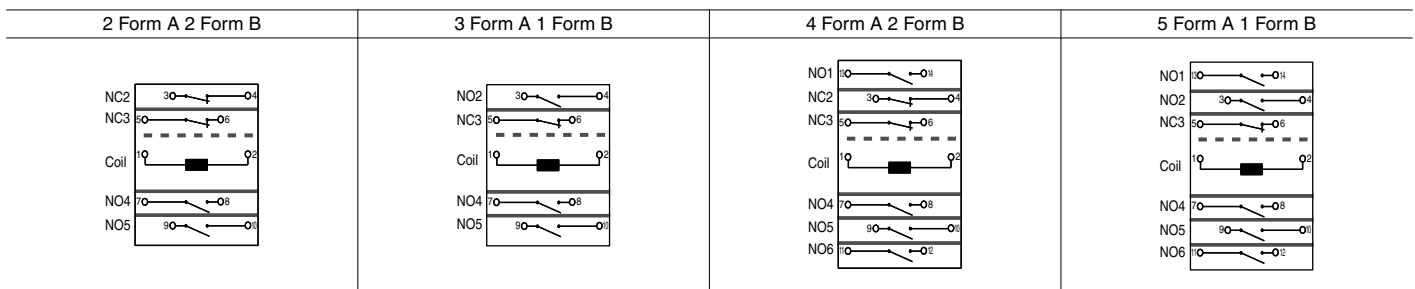

- = Reinforced insulation: overvoltage category III, pollution degree 2, 250V AC (Clearance and creepage distance is 5.5 mm .217 inch or more between contact sets shown by "————". Also, there is 5.5 mm .217 inch or more clearance and creepage distance even between contact NO4 and coil.)
 - - - - = Basic insulation: overvoltage category III, pollution degree 3, 250V AC (Between contact NC3 and coil shown by "- - - -", the clearance is 3 mm .118 inch or more and the creepage distance is 4 mm .157 inch or more.)

Other contact gaps when contacts are welded

The table below shows the state of the other contacts.
 In case of form "NO" contact weld the coil applied voltage is 0 V.
 In case of form "NC" contact weld the coil applied voltage is nominal.

<2 Form A 2 Form B>

| | | State of other contacts | | | |
|---------------------|-----------|-------------------------|----------|----------|-----------|
| | | 3-4 (NC) | 5-6 (NC) | 7-8 (NO) | 9-10 (NO) |
| Welded terminal No. | 3-4 (NC) | | | >0.5 | >0.5 |
| | 5-6 (NC) | | | >0.5 | >0.5 |
| | 7-8 (NO) | >0.5 | >0.5 | | |
| | 9-10 (NO) | >0.5 | >0.5 | | |

<3 Form A 1 Form B>

| | | State of other contacts | | | |
|---------------------|-----------|-------------------------|----------|----------|-----------|
| | | 3-4 (NC) | 5-6 (NO) | 7-8 (NO) | 9-10 (NO) |
| Welded terminal No. | 3-4 (NC) | | >0.5 | >0.5 | >0.5 |
| | 5-6 (NO) | >0.5 | | | |
| | 7-8 (NO) | >0.5 | | | |
| | 9-10 (NO) | >0.5 | | | |

<4 Form A 2 Form B>

| | | State of other contacts | | | | | |
|---------------------|------------|-------------------------|----------|----------|-----------|------------|------------|
| | | 3-4 (NC) | 5-6 (NC) | 7-8 (NO) | 9-10 (NO) | 11-12 (NO) | 13-14 (NO) |
| Welded terminal No. | 3-4 (NC) | | | >0.5 | >0.5 | >0.5 | >0.5 |
| | 5-6 (NC) | | | >0.5 | >0.5 | >0.5 | >0.5 |
| | 7-8 (NO) | >0.5 | >0.5 | | | | |
| | 9-10 (NO) | >0.5 | >0.5 | | | | |
| | 11-12 (NO) | >0.5 | >0.5 | | | | |
| | 13-14 (NO) | >0.5 | >0.5 | | | | |

<5 Form A 1 Form B>

| | | State of other contacts | | | | | |
|---------------------|------------|-------------------------|----------|----------|-----------|------------|------------|
| | | 3-4 (NC) | 5-6 (NO) | 7-8 (NO) | 9-10 (NO) | 11-12 (NO) | 13-14 (NO) |
| Welded terminal No. | 3-4 (NC) | | >0.5 | >0.5 | >0.5 | >0.5 | >0.5 |
| | 5-6 (NO) | >0.5 | | | | | |
| | 7-8 (NO) | >0.5 | | | | | |
| | 9-10 (NO) | >0.5 | | | | | |
| | 11-12 (NO) | >0.5 | | | | | |
| | 13-14 (NO) | >0.5 | | | | | |

>0.5: contact gap is kept at min. 0.5 mm .020 inch
 Empty cells: either ON or OFF
 Note: Contact gaps are shown at the initial state.
 If the contact transfer is caused by load switching, it is necessary to check the actual loading.

DIMENSIONS (mm inch) The CAD data of the products with a **CAD Data** mark can be downloaded from: <http://industrial.panasonic.com/ac/e/>

1. 4-pole (2 Form A 2 Form B, 3 Form A 1 Form B)

CAD Data



External dimensions

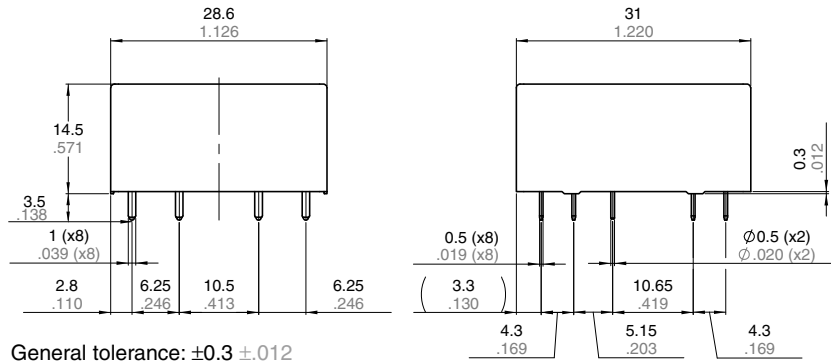

General tolerance: $\pm 0.3 \pm .012$

Projection mode:

Schematic (Bottom view)

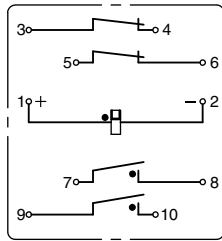

(2 Form A 2 Form B)

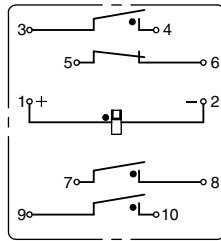

(3 Form A 1 Form B)

PC board pattern (Bottom view)

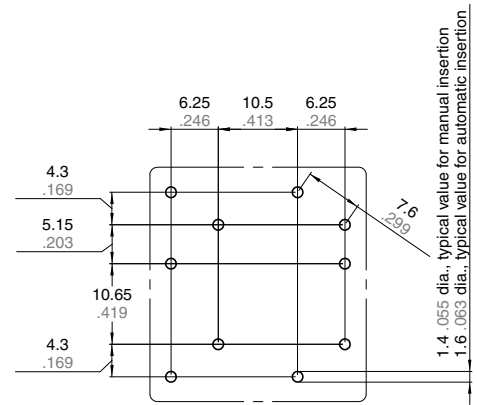

Tolerance: $\pm 0.1 \pm .004$

2. 6-pole (4 Form A 2 Form B, 5 Form A 1 Form B)

CAD Data

External dimensions

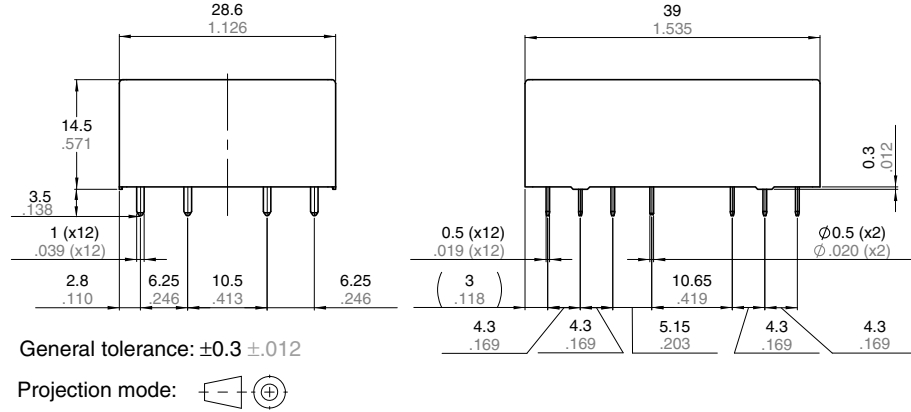

Schematic (Bottom view)

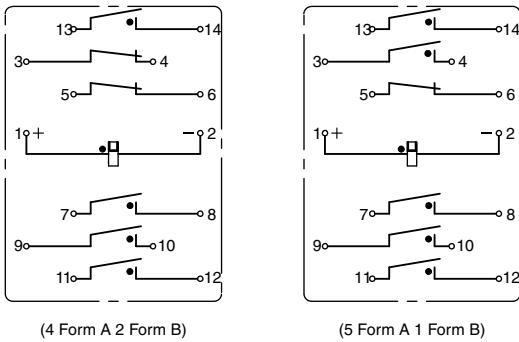

PC board pattern (Bottom view)

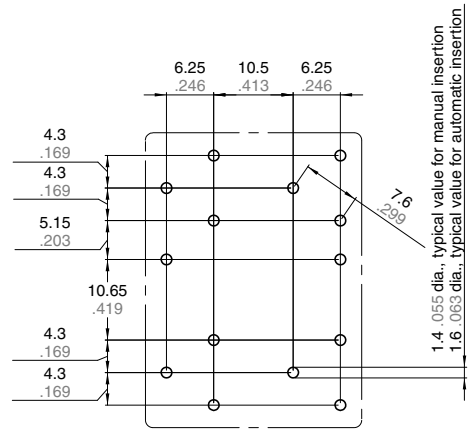

Tolerance: $\pm 0.1 \pm 0.004$

SAFETY STANDARDS

| Certification authority | File No. | Rating |
|-------------------------|-----------------------------|----------------------------------------------------------------------------------------------|
| UL/C-UL | E120782* | 6A 250V AC, general use, 100Kops 6A 30V DC, general use, 100Kops, B300, R300 (pilot duty) |
| TÜV | Cert. no: 968/EZ 535. 00/12 | 6A 230V AC (cosφ=1.0) 70°C 158°F resistive, 6A 24V DC (cosφ=1.0) resistive |

* CSA standard certified by C-UL

NOTES

- 1. For cautions for use, please read "General Application Guidelines" on page B-1.**
- 2. Coil operating power**
Pure DC current should be applied to the coil. The wave form should be rectangular. If it includes ripple, the ripple factor should be less than 5%. However, check it with the actual circuit since the characteristics may be slightly different.

- 3. Coil connection**
When connecting coils, refer to the wiring diagram to prevent mis-operation or malfunction.
- 4. Soldering**
When using automatic soldering, the following conditions are recommended
 1) Preheating: 120°C 248°F, within 120 sec (PC board solder surface)
 2) Soldering: 260°C±5°C 500°F±41°F, within 6 sec