

mm inch

FEATURES

- **Low-profile:** 6 mm .236 inch
(Tape height: max. 6.5 mm .256 inch)
- **Tape and reel package is available as standard packing style**
- **Surge withstand between contacts and coil:** 2,500 V
- **Breakdown voltage between contacts and coil:** 1,500 V
- **Capacity:** 2 A
- **High sensitivity:**
2 Form C; 140 mW power consumption (Single side stable type)

RoHS Directive compatibility information
<http://www.nais-e.com/>

SPECIFICATIONS

| Contact | | | |
|--|--|---|-------------------|
| Arrangement | | 2 Form C | |
| Initial contact resistance, max. (By voltage drop 6 V DC 1 A) | | 75 mΩ | |
| Contact material | | Au-clad AgNi type | |
| Rating | Nominal switching capacity (resistive load) | 2 A 30 V DC, 0.5 A 125 V AC | |
| | Max. switching power (resistive load) | 60 W, 62.5 VA | |
| | Max. switching voltage | 220 V DC, 125 V AC | |
| | Max. switching current | 2 A | |
| | Min. switching capacity (Reference value)*1 | 10 μA 10 mV DC | |
| Nominal operating power | Single side stable | 140 mW (1.5 to 12 V DC) 200 mW (24 V DC) 300 mW (48 V DC) | |
| | 1 coil latching | 70 mW (1.5 to 12 V DC) 100 mW (24 V DC) | |
| | 2 coil latching | 140 mW (1.5 to 12 V DC) 200 mW (24 V DC) | |
| Expected life (min. operations) | Mechanical (at 180 cpm) | 10 ⁸ | |
| | Electrical (at 20 cpm) | 2 A 30 V DC resistive | 10 ⁵ |
| | | 1 A 30 V DC resistive | 2×10 ⁵ |
| | 0.5 A 125 V AC resistive | 10 ⁵ | |

Note:
#1 This value can change due to the switching frequency, environmental conditions, and desired reliability level, therefore it is recommended to check this with the actual load. (SX relays are available for low level load switching [10V DC, 10mA max. level])

Remarks
* Specifications will vary with foreign standards certification ratings.
*1 Measurement at same location as "Initial breakdown voltage" section.
*2 By resistive method, nominal voltage applied to the coil; contact carrying current: 2 A.
*3 Nominal voltage applied to the coil, excluding contact bounce time.
*4 Nominal voltage applied to the coil, excluding contact bounce time without diode.
*5 Half-wave pulse of sine wave: 6 ms; detection time: 10 μs
*6 Half-wave pulse of sine wave: 6 ms
*7 Detection time: 10 μs
*8 Refer to 6. Conditions for operation, transport and storage mentioned in AMBIENT ENVIRONMENT .

| Characteristics | | |
|--|--|---|
| Initial insulation resistance*1 | | Min. 1,000 MΩ (at 500 V DC) |
| Initial breakdown voltage | Between open contacts | 1,000 Vrms for 1 min. (Detection current: 10 mA) |
| | Between contact sets | 1,500 Vrms for 1 min. (Detection current: 10 mA) |
| | Between contact and coil | 1,500 Vrms for 1 min. (Detection current: 10 mA) |
| Initial surge voltage | Between open contacts (10×160 μs) | 1,500 V (FCC Part 68) |
| | Between contacts and coil (2×10 μs) | 2,500 V (Telcordia) |
| Temperature rise*2 (at 20°C) | | Max. 50°C |
| Operate time [Set time]*3 (at 20°C) | | Max. 4 ms [Max. 4 ms] |
| Release time [Reset time]*4 (at 20°C) | | Max. 4 ms [Max. 4 ms] |
| Shock resistance | Functional*5 | Min. 750 m/s ² {75 G} |
| | Destructive*6 | Min. 1,000 m/s ² {100 G} |
| Vibration resistance | Functional*7 | 200 m/s ² {20G}, 10 to 55 Hz at double amplitude of 3.3 mm |
| | Destructive | 294 m/s ² {30G}, 10 to 55 Hz at double amplitude of 5 mm |
| Conditions for operation, transport and storage*8 (Not freezing and condensing at low temperature) | Ambient temperature | -40°C to +85°C*3 -40°F to +185°F |
| | Humidity | 5 to 85% R.H. |
| Unit weight | | Approx. 2 g .071 oz |

ORDERING INFORMATION

Ex. TQ 2 SA - L - 3V - Z

| Contact arrangement | Surface-mount availability | Operating function | Coil voltage (DC) | Packing style |
|---------------------|---|--|-------------------------------------|---|
| 2: 2 Form C | SA: Standard surface-mount terminal type SL: High connection reliability surface-mount terminal type SS: Space saving surface-mount terminal type | Nil: Single side stable L: 1 coil latching L2: 2 coil latching | 1.5, 3, 4.5, 5, 6, 9, 12, 24, 48* V | Nil: Tube packing Z: Tape and reel packing (picked from the 6/7/8/9/10-pin side) |

*48 V coil type: Single side stable only

Notes: 1. Tape and reel (picked from 1/2/3/4/5-pin side) is also available by request. Part No. suffix "-X" is needed when ordering. (ex.) TQ2SA-3V-X
2. Tape and reel packing symbol "-Z" or "-X" are not marked on the relay.

TYPES

1. Single side stable

| Part No. | Nominal voltage, V DC | Pick-up voltage, V DC (max.) | Drop-out voltage, V DC (min.) | Nominal operating current, mA ($\pm 10\%$) | Coil resistance, Ω ($\pm 10\%$) | Nominal operating power, mW | Max. allowable voltage, V DC |
|-------------|-----------------------|------------------------------|-------------------------------|--|--|-----------------------------|------------------------------|
| TQ2SO-1.5 V | 1.5 | 1.13 | 0.15 | 93.8 | 16 | 140 | 2.2 |
| TQ2SO-3 V | 3 | 2.25 | 0.3 | 46.7 | 64.3 | 140 | 4.5 |
| TQ2SO-4.5 V | 4.5 | 3.38 | 0.45 | 31 | 145 | 140 | 6.7 |
| TQ2SO-5 V | 5 | 3.75 | 0.5 | 28.1 | 178 | 140 | 7.5 |
| TQ2SO-6 V | 6 | 4.5 | 0.6 | 23.3 | 257 | 140 | 9 |
| TQ2SO-9 V | 9 | 6.75 | 0.9 | 15.5 | 579 | 140 | 13.5 |
| TQ2SO-12 V | 12 | 9 | 1.2 | 11.7 | 1,028 | 140 | 18 |
| TQ2SO-24 V | 24 | 18 | 2.4 | 8.3 | 2,880 | 200 | 36 |
| TQ2SO-48 V | 48 | 36 | 4.8 | 6.3 | 7,680 | 300 | 57.6 |

2. 1 coil latching

| Part No. | Nominal voltage, V DC | Set voltage, V DC (max.) | Reset voltage, V DC (max.) | Nominal operating current, mA ($\pm 10\%$) | Coil resistance, Ω ($\pm 10\%$) | Nominal operating power, mW | Max. allowable voltage, V DC |
|---------------|-----------------------|--------------------------|----------------------------|--|--|-----------------------------|------------------------------|
| TQ2SO-L-1.5 V | 1.5 | 1.13 | 1.13 | 46.9 | 32 | 70 | 2.2 |
| TQ2SO-L-3 V | 3 | 2.25 | 2.25 | 23.3 | 128.6 | 70 | 4.5 |
| TQ2SO-L-4.5 V | 4.5 | 3.38 | 3.38 | 15.6 | 289.3 | 70 | 6.7 |
| TQ2SO-L-5 V | 5 | 3.75 | 3.75 | 14 | 357 | 70 | 7.5 |
| TQ2SO-L-6 V | 6 | 4.5 | 4.5 | 11.7 | 514 | 70 | 9 |
| TQ2SO-L-9 V | 9 | 6.75 | 6.75 | 7.8 | 1,157 | 70 | 13.5 |
| TQ2SO-L-12 V | 12 | 9 | 9 | 5.8 | 2,057 | 70 | 18 |
| TQ2SO-L-24 V | 24 | 18 | 18 | 4.2 | 5,760 | 100 | 36 |

3. 2 coil latching

| Part No. | Nominal voltage, V DC | Set voltage, V DC (max.) | Reset voltage, V DC (max.) | Nominal operating current, mA ($\pm 10\%$) | Coil resistance, Ω ($\pm 10\%$) | Nominal operating power, mW | Max. allowable voltage, V DC |
|----------------|-----------------------|--------------------------|----------------------------|--|--|-----------------------------|------------------------------|
| TQ2SO-L2-1.5 V | 1.5 | 1.13 | 1.13 | 93.8 | 16 | 140 | 2.2 |
| TQ2SO-L2-3 V | 3 | 2.25 | 2.25 | 46.7 | 64.3 | 140 | 4.5 |
| TQ2SO-L2-4.5 V | 4.5 | 3.38 | 3.38 | 31 | 145 | 140 | 6.7 |
| TQ2SO-L2-5 V | 5 | 3.75 | 3.75 | 28.1 | 178 | 140 | 7.5 |
| TQ2SO-L2-6 V | 6 | 4.5 | 4.5 | 23.3 | 257 | 140 | 9 |
| TQ2SO-L2-9 V | 9 | 6.75 | 6.75 | 15.5 | 579 | 140 | 13.5 |
| TQ2SO-L2-12 V | 12 | 9 | 9 | 11.7 | 1,028 | 140 | 18 |
| TQ2SO-L2-24 V | 24 | 18 | 18 | 8.3 | 2,880 | 200 | 36 |

○: For each surface-mounted terminal variation, input the following letter.

SA type: A, SL type: L, SS type: S

Notes: 1. Specified value of the pick-up, drop-out, set and reset voltage is with the condition of square wave coil pulse.

2. Standard packing: Tube: 50 pcs.; Case: 1,000 pcs.

Tape and reel: 500 pcs.; Case: 1,000 pcs.

3. In case of 5 V transistor drive circuit, it is recommended to use 4.5 V type relay.

TQ SMD

DIMENSIONS

mm inch

SA type

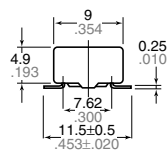
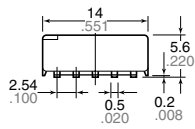

Recommendable mounting pad (Top view) SA type

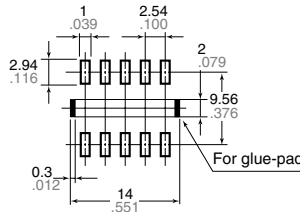

SL type

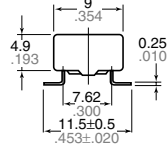
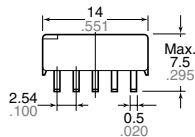

SL type

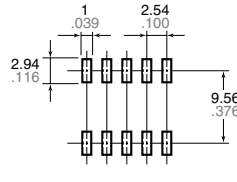

SS type

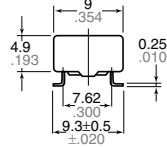
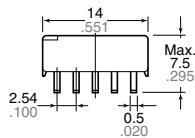

SS type

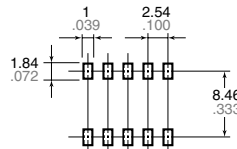

General tolerance: $\pm 0.3 \pm 0.012$

Tolerance: $\pm 0.1 \pm 0.004$

Schematic (Top view)

- Single side stable (Deenergized condition)

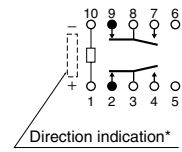

*Orientation stripe located on top of relay.

- 1-coil latching (Reset condition)

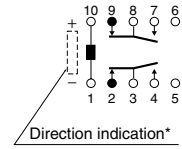

*Orientation stripe located on top of relay.

- 2-coil latching (Reset condition)

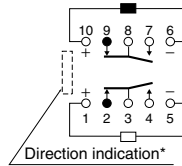

*Orientation stripe located on top of relay.

REFERENCE DATA

1. Maximum switching capacity

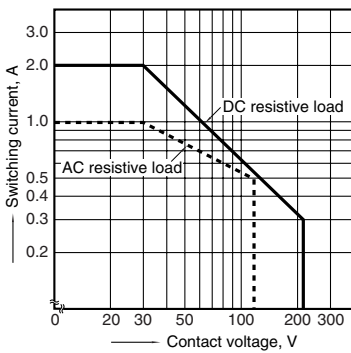

2. Life curve

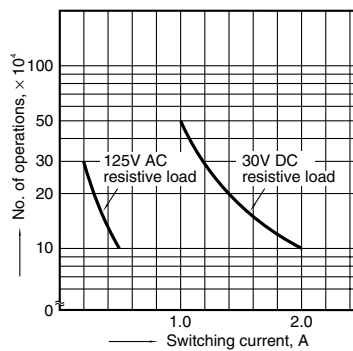

3. Mechanical life (mounting by IRS method)

Tested sample: TQ2SA-12V, 10 pcs.

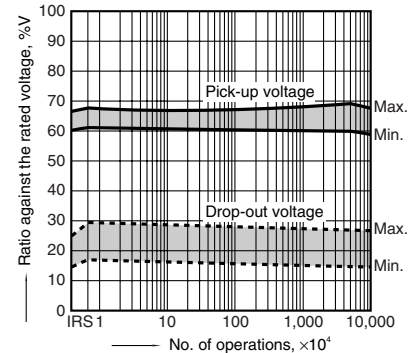

4.-(1) Electrical life (2 A 30 V DC resistive load)

Tested sample: TQ2SA-12V, 6 pcs.

Operating frequency: 20 cpm

Change of pick-up and drop-out voltage (mounting by IRS method)

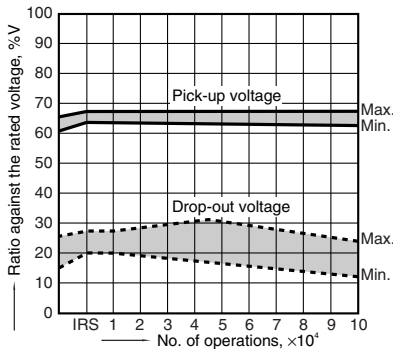

Change of contact resistance (mounting by IRS method)

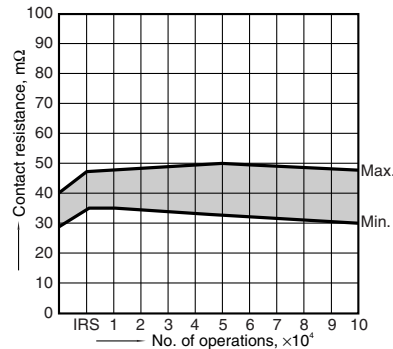

4.-(2) Electrical life (0.5 A 125 V AC resistive load)

Tested sample: TQ2SA-12V, 6 pcs

Operating frequency: 20 cpm

Change of pick-up and drop-out voltage (mounting by IRS method)

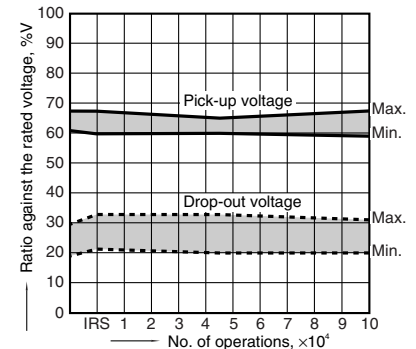

Change of contact resistance (mounting by IRS method)

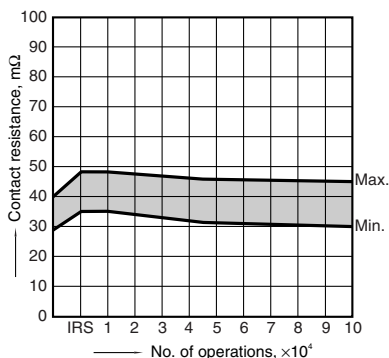

5. Coil temperature rise
Tested sample: TQ2SA-12V, 6 pcs.
Point measured: Inside the coil
Ambient temperature: 25°C 77°F

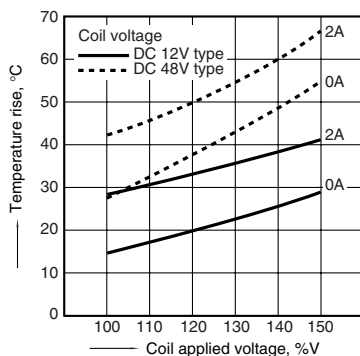

6. Operate/release time
Tested sample: TQ2SA-12V, 6 pcs.

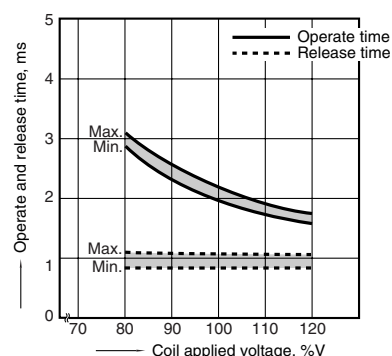

7. Distribution of pick-up and drop out voltage
Tested sample: TQ2SA-12V, 50 pcs.

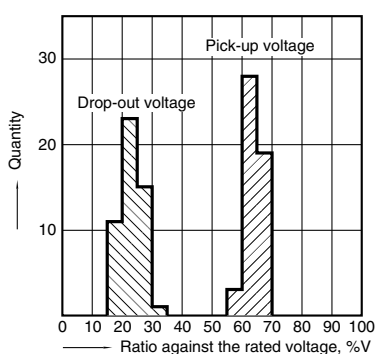

8. Distribution of set and reset voltage
Tested sample: TQ2SA-L-12V, 30 pcs.

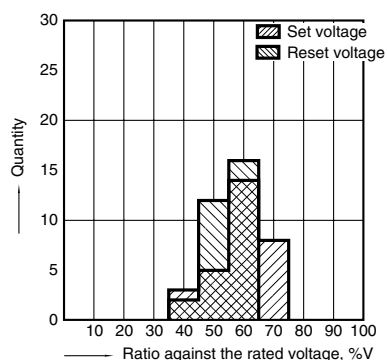

9. Ambient temperature characteristics
Tested sample: TQ2SA-12V, 5 pcs.

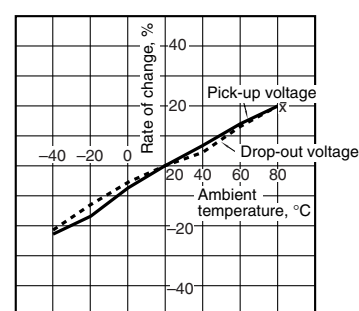

10. Distribution of contact resistance
Tested sample: TQ2SA-5V, 30 pcs. (30 x 4 contacts)

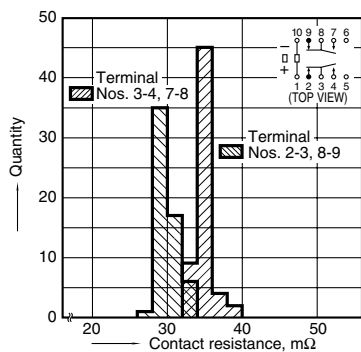

11.-(1) High-frequency characteristics
Isolation characteristics

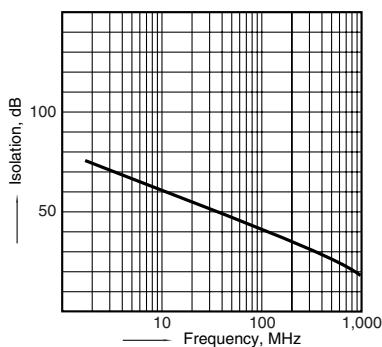

11.-(2) High-frequency characteristics
Insertion loss characteristics

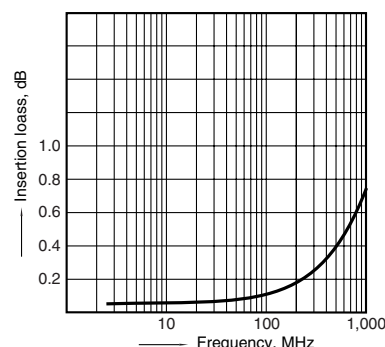

12.-(1) Malfunctional shock (single side stable)
Tested sample: TQ2SA-12V, 6 pcs

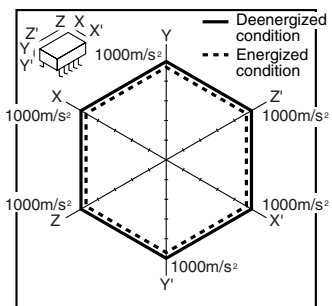

12.-(2) Malfunctional shock (latching)
Tested sample: TQ2SA-L2-12V, 6 pcs.

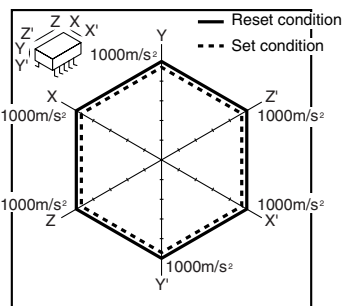

TQ SMD

13.-(1) Influence of adjacent mounting
Tested sample: TQ2SA-12V, 5 pcs.

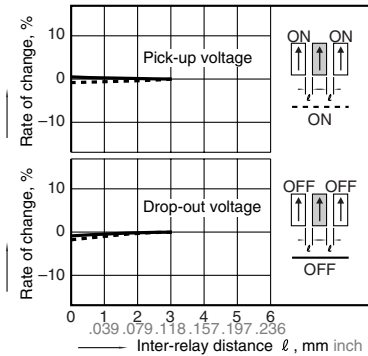

13.-(2) Influence of adjacent mounting
Tested sample: TQ2SA-12V, 6 pcs.

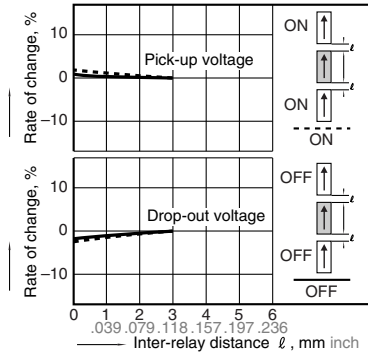

13.-(3) Influence of adjacent mounting
Tested sample: TQ2SA-12V, 6 pcs.

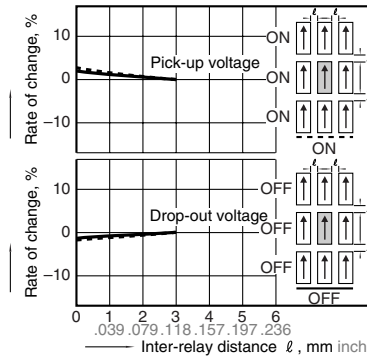

14. Pulse dialing test

Tested sample: TQ2SA-12V, 6 pcs.
(35 mA 48 V DC wire spring relay load)
Circuit

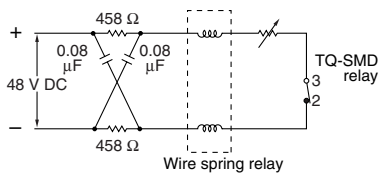

Change of pick-up and drop-out voltage
(mounting by IRS method)

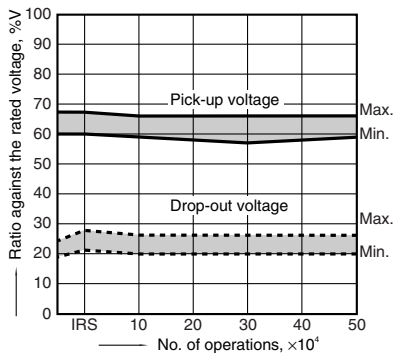

Change of contact resistance
(mounting by IRS method)

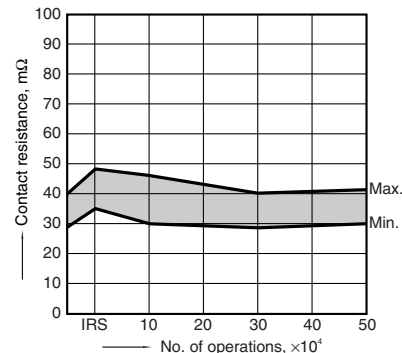

NOTES

1. Packing style

1) The relay is packed in a tube with the relay orientation mark on the left side, as shown in the figure below.

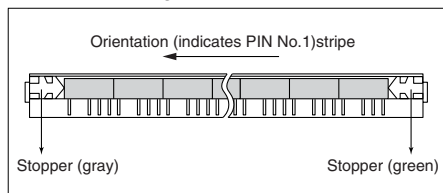

2) Tape and reel packing (surface-mount terminal type)

(1) Tape dimensions

(i) SA type

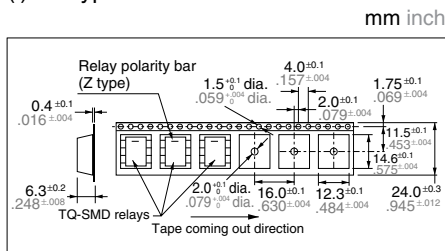

(ii) SL, SS type

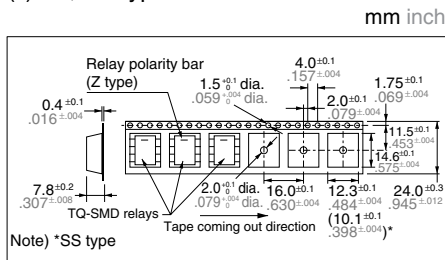

(2) Dimensions of plastic reel

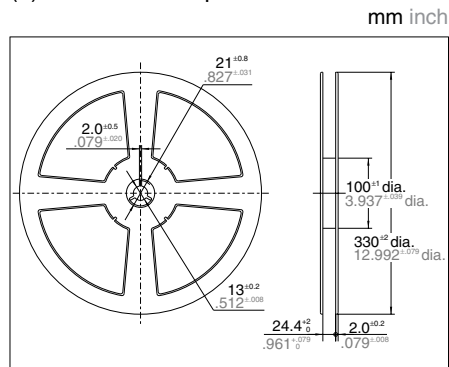

For Cautions for Use, see Relay Technical Information.