

Space Saving Cable Management Rack Systems



PANDUIT[®]

building a smarter,
unified business foundation
Connect. Manage. Automate.

Panduit's Unified Physical Infrastructure (UPI): a Guiding Approach

A unified approach to physical and logical systems architecture is imperative for solutions to fully address the need for availability, agility, integration, and security.

Panduit has developed the industry's most comprehensive and holistic approach to a Unified Physical Infrastructure and can help enterprises align, converge, and optimize critical systems – communication, computing, control, power, and security – to build a smarter, unified business foundation.

Mitigate Risk – Efficient physical infrastructure management enables seamless integration to reduce risks which can occur throughout core systems.

Lower Cost – Panduit physical infrastructure solutions drive financial advantages to reduce energy and occupancy costs, and help secure competitive advantage.

Increase Agility – A high level of integration within the physical infrastructure enables flexibility and improved business agility.

Enhance Sustainability – UPI-based solution offerings enable organizations to meet sustainability goals by driving resource and energy efficiencies across the physical infrastructure.

Unified Physical Infrastructure



Maximize Space Utilization, Enhance Network Reliability

The trend towards consolidation, virtualization and automation in the enterprise is driving the need to maximize space utilization to reduce capital expenditures and operational costs while maintaining network reliability and availability. This trend is placing greater demands on the physical infrastructure to help manage growing cable densities, larger network equipment and increasing energy usage.

Space Optimized, High Capacity Cable Management Systems

Panduit builds on years of experience as a leader in cable management, integrating best practices and application knowledge to develop highly reliable and efficient physical infrastructure solutions. Panduit's comprehensive offering of vertical cable management, horizontal cable management, and rack solutions reduces space required to route, manage and protect high cable capacities, providing the lowest total cost of ownership. These product sets can be combined to provide an optimized solution for virtually any application.

PatchRunner™ and NetRunner™ Vertical Cable Management Systems address the needs of the data center and telecommunications rooms to deliver improved network performance and reduced real estate costs. Superior cable management features and innovative vertical RU mounting maximize capacity and enable efficient moves, adds, and changes to reduce operational costs.

PatchRunner™ High Capacity Vertical Cable Management System

PatchRunner™ High Capacity Vertical Cable Managers are optimized to provide the maximum amount of capacity, flexibility and accessibility for high density switch and server applications.

NetRunner™ High Capacity Vertical Cable Management System

NetRunner™ High Capacity Vertical Cable Managers are designed to provide the best combination of features and value for standard density enterprise telecommunications rooms and data center applications.

Thermal Management

Panduit's passive, optimized thermal management solutions enable high density, high heat load data center design while reducing energy costs.

2 Post and 4 Post Racks

PatchRunner™ and NetRunner™ High Capacity Systems can be seamlessly integrated into Panduit's versatile 2 post and 4 post racks. Designed for today's larger network equipment, Panduit racks provide strength, capacity and thermal features that help ensure network availability. The 2 post and 4 post rack thermal accessories provide proper heat dissipation of active equipment, improving network reliability.

Reduce Real Estate Cost and Space Utilization by 35% with Panduit High Capacity Cable Management Systems

Panduit High Capacity Cable Management Systems enable the maximum amount of cables to be managed in a minimum amount of space, reducing the square footage required to deploy high density network switching and patching by up to 35%. Innovative cable management features allow efficient organization and protection of high performance copper and fiber optic cables, enhancing network reliability and reducing operational expense.



Floor Space Required

Layout	Traditional NetRunner™ Vertical Cable Management System	High Density PatchRunner™ High Capacity Vertical Cable Management System	Vertical Patching PatchRunner™ High Capacity Vertical Cable Management System
Footprint Width	114.6" (2.91m)	68.6" (1.74m)	44.3" (1.13m)
Areas	21.1 Sq. ft.	13.4 Sq. ft.	8.7 Sq. ft.
Real Estate Cost	\$54,016	\$34,304	\$22,272

Real estate cost based on a 2010 Gartner estimate for a Tier 3 data center. Refer to page 18 and 19 for capacity and space requirements for specific solutions.

High Density Solutions for the Cisco[^] Nexus 7010 Switch

High performance network switching requires innovations to be extended into every aspect of the physical infrastructure. New concepts for managing equipment, connectivity, and available space are needed to provide maximum density, scalability and usability. The PatchRunner™ High Capacity Vertical Cable Management System with 4 post rack equipment management offers the highest cable capacities for maximum densities, vertical patching and accessories for scalability and superior space utilization.

Maximum Capacity with Minimal Space

- Vertical patching enables two Cisco[^] Nexus 7010 Switches to be deployed within a single rack, eliminating the need for a separate patching rack



- Strong, flexible fingers support Category 6A cables without deforming

- Enables standard 19" patch panels to be mounted vertically, freeing up rack spaces for additional equipment



- Allows patch panels to be positioned near switch ports, optimizing patch cord lengths

- Accepts either copper or fiber patch panels

- Minimizes slacking and allows for a more efficient use of the vertical manager space

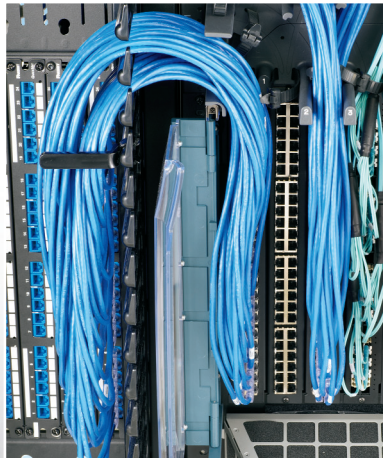



Maximum Versatility and Strength

- The 4 post rack depth encases Nexus 7010 switches, providing increased physical protection
- Rack features allow quick POU mounting
- UL listed 2500 lb. (1134kg) load rating securely supports two Nexus 7010 switches and cabling



Infrastructure Showcase

- The NEW push shut door with visual and audible feedback delivers a clean aesthetic look
- End panels enable the vertical managers to be closed off, increasing protection and providing a clean look at the end of your lineup



High Density Solutions for the Cisco[^] Nexus 7009 Switch

Effectively deploying the latest high performance network switches requires in-depth knowledge of cable management, infrastructure, thermal management, and the ability to apply that knowledge in the creation of superior solutions.

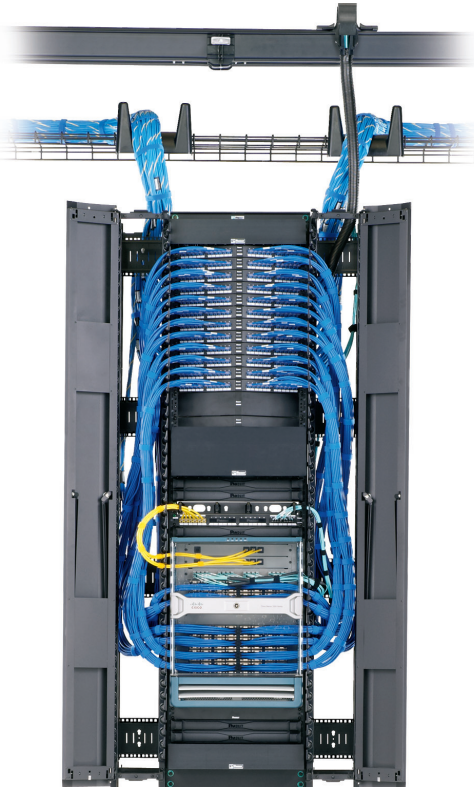

Equipment management is part of the foundation of the Unified Physical InfrastructureSM (UPI) approach, providing full structure protection of equipment, delivering UL rated support, and respecting equipment airflow patterns. Vertical cable management that not only provides slacking of patch cords, but goes beyond in the ability to support options to simplify system organization and interface to the system-wide infrastructure.

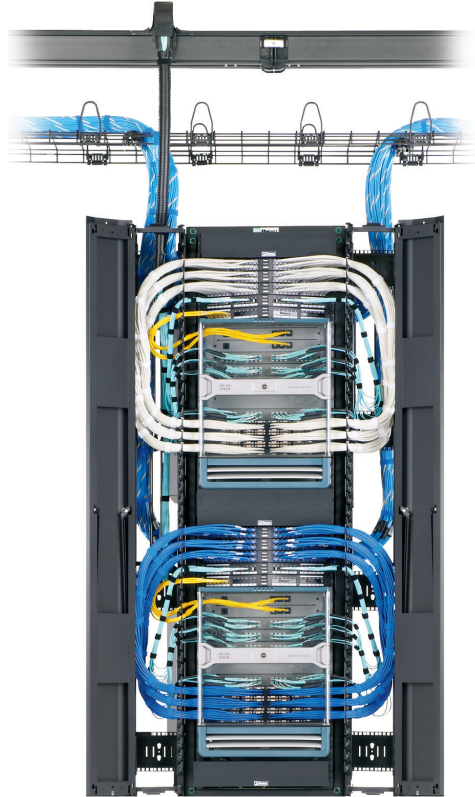

- FiberRunner[®] and Wyr-Grid[®] Overhead Routing Systems (depicted at top left and right) route, manage, and protect cables throughout the data center*.

Cable Management



- Space between individual fingers organize up to 48 Category 6A cables



- Deep vertical managers provide space to manage high densities

Infrastructure

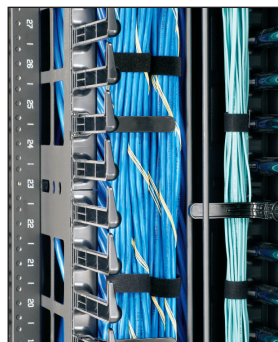

- Vertically oriented strain relief bars effectively manage structured cabling in the rear of the rack and provide separation of cable types

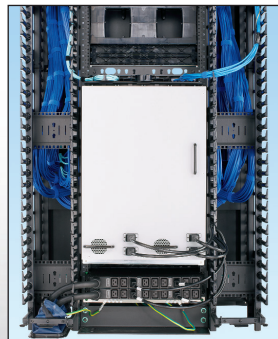

- Flexible power outlet unit mounting for any equipment power requirements

Thermal Management



- Open areas respect equipment airflow patterns

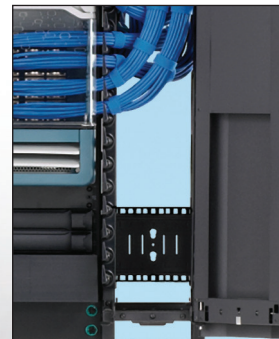

- Front to back spaces can be closed off for hot/cold aisle applications

*Download the Wyr-Grid[®] Overhead Cable Tray Routing System brochure (SA-RKCB18) and FiberRunner[®] Application Guide (SA-FRCB02) at www.panduit.com.

Thermal Management Solutions for Cisco[^] Nexus 7000 and Catalyst 6500 Series Network Switches

For network equipment that utilize side-to-side airflow patterns, such as the Cisco Nexus 7009, 7018, and Catalyst 6500 Series Switches, rack mounted exhaust ducts can be used to optimize cooling efficiency by establishing a front to back airflow pattern.

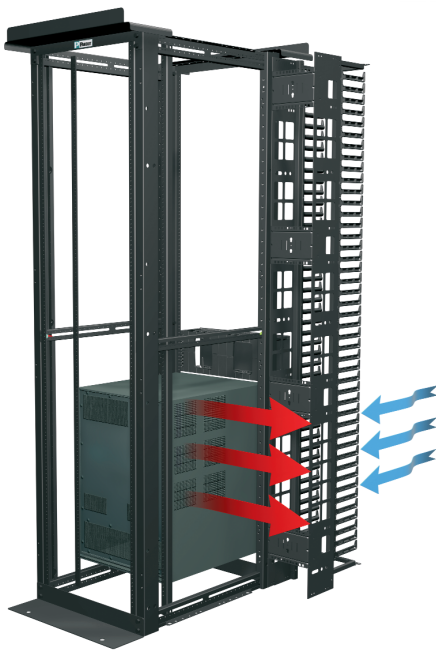

4 post rack configured without thermal exhaust duct

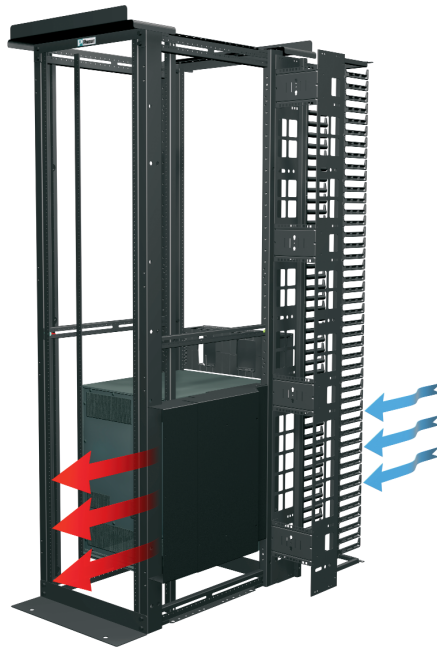

4 post rack configured with a thermal exhaust duct illustrating a front to back airflow pattern

Controlling Exhaust Air via Ducting

- A thermal exhaust duct prevents preheated air exhausted from a side-to-side airflow switch from entering the adjacent switch inlet

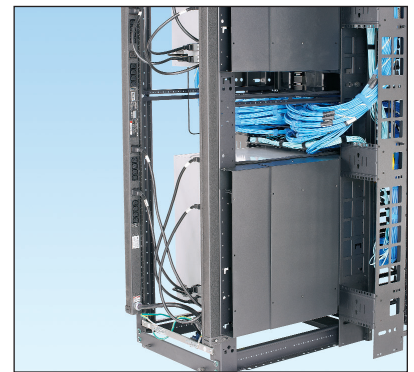

Panduit 4 post rack thermal ducts shown in a dual Nexus 7009 switch deployment.

Shown below is a front access cross sectional view of a multi-rack lineup, demonstrating thermal exhaust temperatures both with and without thermal exhaust ducts.

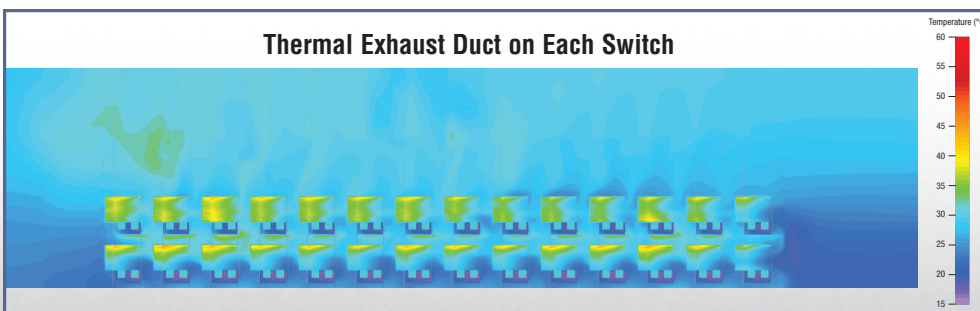
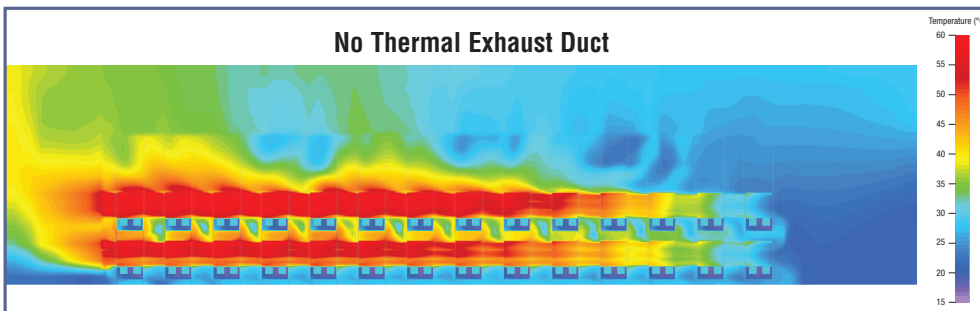

By redirecting the exhaust, the following benefits are achieved

- Lower inlet temperatures
- Variable speed fans run at slower speeds
- Decreased thermal stress on system, improving reliability
- Decreased energy usage

PatchRunner™ High Capacity Vertical Cable Management System

The capacity of this vertical manager is ideal for Category 6A cabling or other High Speed Data Transport cabling. Integral EIA zero rack space mounting capability in the back of the manager allows equipment to be patched in the PatchRunner™ High Capacity Vertical Cable Manager, freeing up valuable rack space for equipment and allowing the use of shorter length patch cords.

1 4 Post Rack

- R4P**
84.0"H x 23.25"W x 30.0"D
45 rack spaces
- R4P23**
84.0"H x 23.25"W x 23.0"D
45 rack spaces
- R4P36**
84.0"H x 23.25"W x 36.0"D
45 rack spaces
- R4P42**
84.0"H x 23.25"W x 41.5"D
45 rack spaces

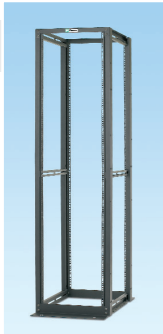

2 PEV12

- PatchRunner™ High Capacity Vertical Cable Managers
- Available in 6", 8", 10", and 12" widths

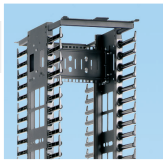

3 PED12

- PatchRunner™ High Capacity Dual Hinged Metal Doors
- Available in 6", 8", 10", and 12" widths



4 R4PWF

- Rack Top Trough with Waterfall creates pathway above rack

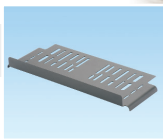

5 NCMH2

- NetManager™ Horizontal Cable Manager

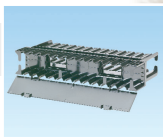

6 NM2

- NetManager™ High Capacity Horizontal Cable Manager



7 PEHF3

- PatchRunner™ High Capacity Horizontal Cable Manager

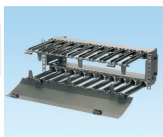

8 RFG6X8

- Cool Boot® Raised Floor Air Sealing Grommet

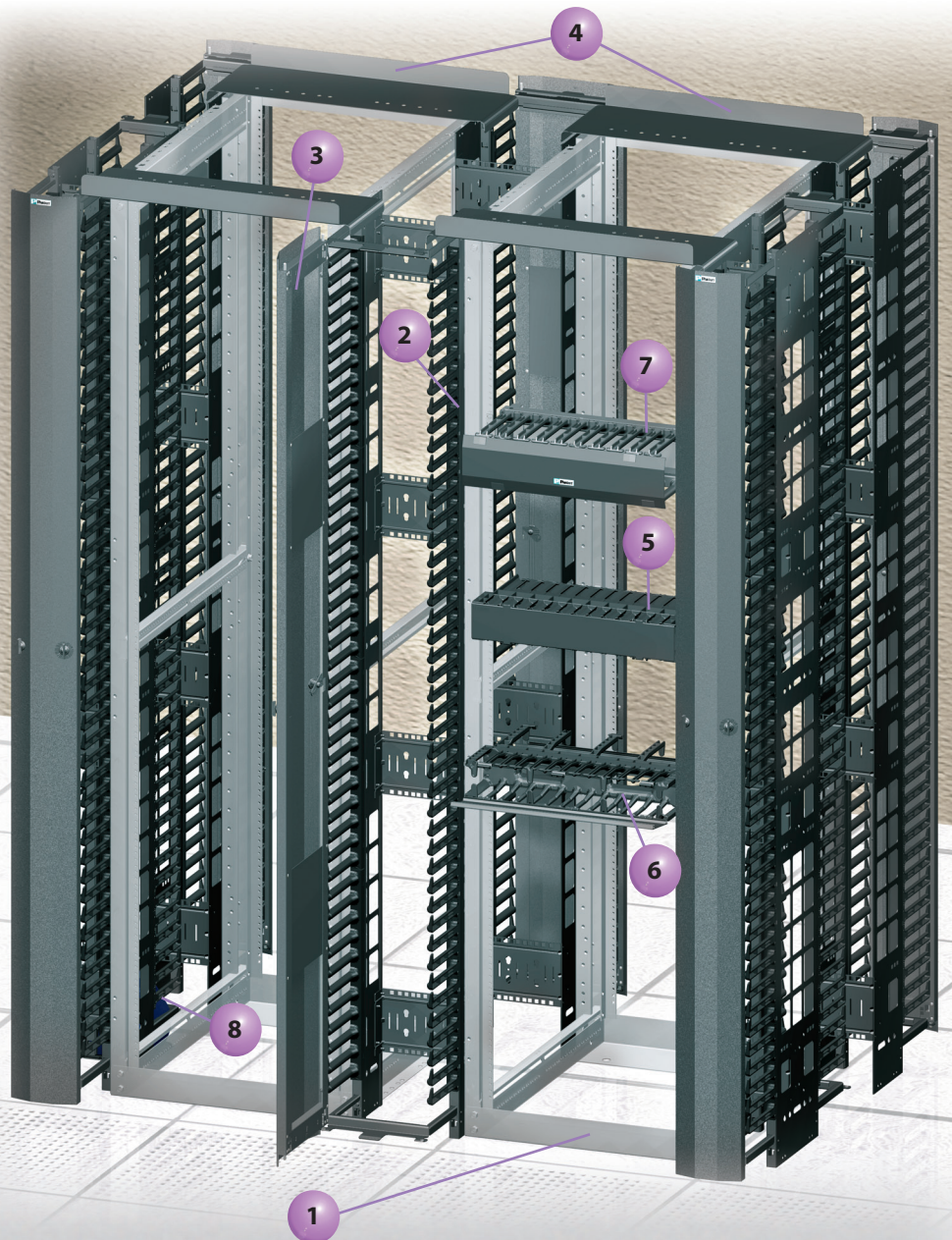

PatchRunner™ High Capacity Vertical Cable Managers

- High capacity minimizes area required for network layout, freeing up valuable floor space
- Allows vertical mounting of many standard EIA 19" accessories, such as patch panels
- Ventilated side walls provide maximum airflow for equipment cooling
- Snap-on finger sections can be removed to improve airflow, and break away fingers allow routing of large cable bundles
- Large finger spacing accommodates up to 48 Category 6A cables
- Optional sure close dual hinged metal doors provide easy access to vertical pathway and provide visual and audible feedback on closure

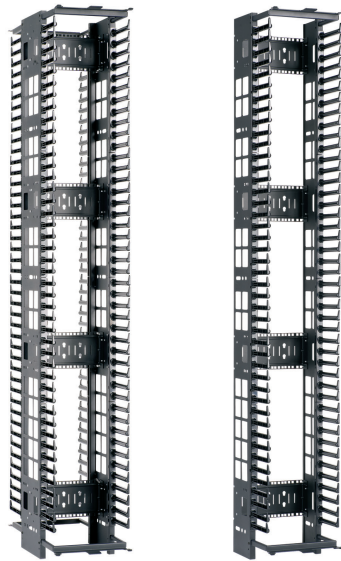

PEV

PEVF



PED



PEVEP



PEVBRC



SRB19D7BL

Part Number	Part Description	No. of Rack Spaces‡	Std. Pkg. Qty.
-------------	------------------	---------------------	----------------

High Capacity Dual Sided Vertical Managers

PEV6*	Dimensions: 83.5"H x 6.0"W x 28.1"D (2120mm x 152mm x 714mm).	45	1
PEV8*	Dimensions: 83.5"H x 8.0"W x 28.1"D (2120mm x 203mm x 714mm).	45	1
PEV10*	Dimensions: 83.5"H x 10.0"W x 28.1"D (2120mm x 254mm x 714mm).	45	1
PEV12*	Dimensions: 83.5"H x 12.0"W x 28.1"D (2120mm x 305mm x 714mm).	45	1

High Capacity Single Sided Vertical Managers

PEVF6*	Dimensions: 83.5"H x 6.0"W x 15.9"D (2120mm x 152mm x 404mm).	45	1
PEVF8*	Dimensions: 83.5"H x 8.0"W x 15.9"D (2120mm x 203mm x 404mm).	45	1
PEVF10*	Dimensions: 83.5"H x 10.0"W x 15.9"D (2120mm x 254mm x 404mm).	45	1
PEVF12*	Dimensions: 83.5"H x 12.0"W x 15.9"D (2120mm x 305mm x 404mm).	45	1

PatchRunner™ High Capacity Dual Hinged Metal Doors

PED6*	Dimensions: 82.8"H x 6.1"W x 1.7"D (2103mm x 155mm x 43mm).	45	1
PED8*	Dimensions: 82.8"H x 8.1"W x 1.7"D (2103mm x 206mm x 43mm).	45	1
PED10*	Dimensions: 82.8"H x 10.1"W x 1.7"D (2103mm x 256mm x 43mm).	45	1
PED12*	Dimensions: 82.8"H x 12.1"W x 1.7"D (2103mm x 307mm x 43mm).	45	1

Accessories

PEVEP	End Panel. Dimensions: 83.7"H x 23.2"W x .5"D (2125mm x 590mm x 12mm).	—	1
PEVBRC6	Horizontal cross brace bend radius control clips for PatchRunner™ High Capacity Vertical Cable Managers PEV6 and PEVF6.	—	1
PEVBRC8	Horizontal cross brace bend radius control clips for PatchRunner™ High Capacity Vertical Cable Managers PEV8 and PEVF8.	—	1
PEVBRC10	Horizontal cross brace bend radius control clips for PatchRunner™ High Capacity Vertical Cable Managers PEV10 and PEVF10.	—	1
PEVBRC12	Horizontal cross brace bend radius control clips for PatchRunner™ High Capacity Vertical Cable Managers PEV12 and PEVF12.	—	1
SRB19D7BL	Strain relief bar extends 7" off the rack; supports, manages, and provides proper bend radius protection. Ideal for use with Category 6A copper cabling installations.	—	1

*For part numbers that fit 8' rack, add "96" to end of part number. Overall height for managers is 95.5" (2426mm).

Overall door height is 94.4" (2399mm).

‡One rack space = 1.75" (44.45mm).

All product color is black.

For PatchRunner™ High Capacity Vertical Cable Manager Specifications, see page 18.

1 2 Post Rack

- R2P**
84.0"H x 20.3"W x 3.0"D
45 rack spaces
aluminum
- R2PS**
84.0"H x 20.3"W x 3.0"D
45 rack spaces
steel
- R2PW**
84.0"H x 24.3"W x 3.0"D
45 rack spaces



2 NRV12

- 12"W Front and Rear Vertical Manager – 45 rack spaces

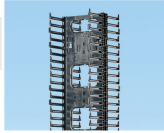

3 NRD12

- Dual Hinged Metal Door – 45 rack spaces



4 WMPV45ERTW

- Rack Top Trough with Waterfall creates pathway above rack

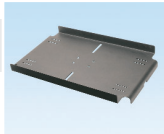

5 NREP

- End panel for NRV NetRunner™ High Capacity Vertical Cable Managers



6 CMPH2

- 2 RU Open-Access™ Horizontal Cable Manager D-rings



7 WMPH2E

- 2 RU PatchLink™ Horizontal Cable Manager



8 NCMH2

- NetManager™ Horizontal Cable Manager

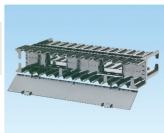

9 NM2

- NetManager™ High Capacity Horizontal Cable Manager



10 RFG6X8

- Cool Boot® Raised Floor Air Sealing Grommet



11 R2PPDUB

- Power Outlet Unit (POU) bracket for 2 and 4 post racks



NetRunner™ High Capacity Vertical Cable Management System

Provides cost effective solutions that organize, manage, protect and showcase network cabling while ensuring system performance and reliability. Optimal compatibility with Panduit racks, patch panels, and connectivity provides a complete end-to-end solution.

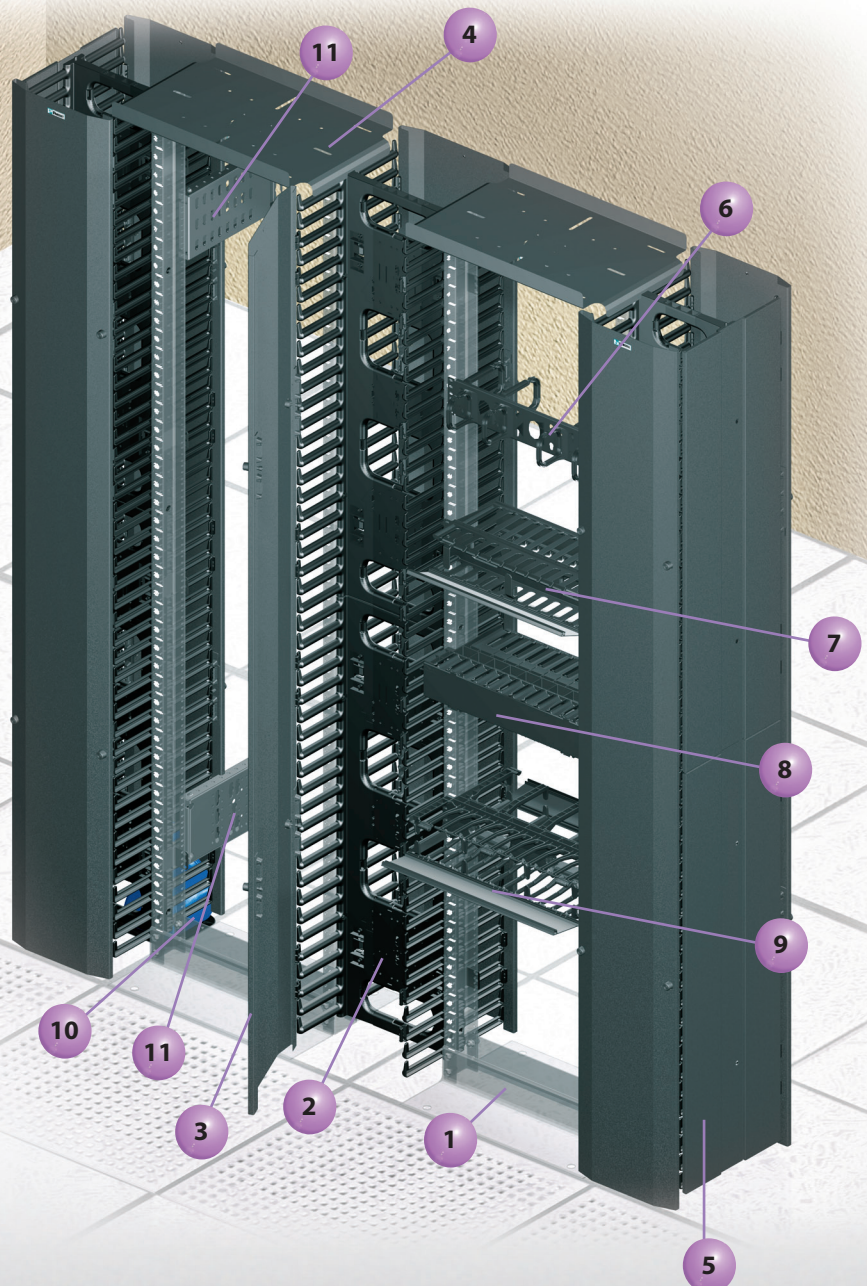

NetRunner™ High Capacity Vertical Cable Managers

- Large finger openings accommodate up to 24 Category 6A cables
- Push button dual hinged doors ordered separately can be opened 110° to the left or right to provide complete access to the cables inside the vertical pathway
- Snap-on cable retainers can be placed onto fingers to help retain cables in channel during installation and maintenance
- Vertical managers include cable retainers, mounting brackets and #12-24 screws
- For 2 post 3" channel racks and 4 post racks

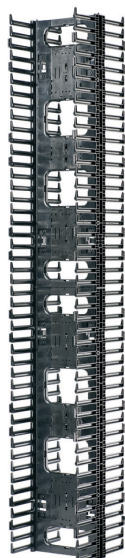

NRV



NRVF



NRD



NREP



NRVCB

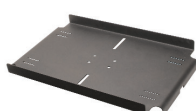

WMPV45ERTW

Part Number	Part Description	No. of Rack Spaces‡	Std. Pkg. Qty
High Capacity Dual Sided Vertical Managers			
NRV6	Dimensions: 80.4"H x 6.7"W x 13.8"D (2042mm x 170mm x 350mm).	45	1
NRV10	Dimensions: 80.4"H x 10.0"W x 13.8"D (2042mm x 254mm x 350mm).	45	1
NRV12	Dimensions: 80.4"H x 12.0"W x 13.8"D (2042mm x 305mm x 350mm).	45	1
High Capacity Single Sided Vertical Managers			
NRVF6	Dimensions: 80.4"H x 6.7"W x 7.48"D (2042mm x 170mm x 190mm).	45	1
NRVF10	Dimensions: 80.4"H x 10.0"W x 7.48"D (2042mm x 254mm x 190mm).	45	1
NRVF12	Dimensions: 80.4"H x 12.0"W x 7.48"D (2042mm x 305mm x 190mm).	45	1
High Capacity Dual Hinged Metal Doors			
NRD6	Dimensions: 82.8"H x 7.4"W x 1.6"D (2104mm x 188mm x 40mm).	45	1
NRD10	Dimensions: 82.8"H x 10.7"W x 1.6"D (2104mm x 272mm x 40mm).	45	1
NRD12	Dimensions: 82.8"H x 12.7"W x 1.6"D (2104mm x 322mm x 40mm).	45	1
Accessories			
NRVCB	NetRunner™ High Capacity Center Mount Bracket Kit. For use with CEA-310-E standard 2 post and Panduit 4 Post Racks.	—	1
NREP	End panel for use with NRV series, WMPVHCF45E / WMPVHC45E.	—	1
WMPV45ERTW	Rack top trough with waterfall door 2 post 3" channel rack.	—	1

‡One rack space = 1.75" (44.45mm).

All product color is black.

For NetRunner™ High Capacity Vertical Cable Manager Specifications, see page19.

4 Post Cable Management Rack System

Deep 4 post open server racks provide the necessary environment for high density server applications. The open design assures maximum ventilation while minimizing air mixing in hot/cold aisle configurations. Space in the rear of the 4 post racks allows for server power, cable management and patching, providing an efficient and functional server solution.

1 4 Post Rack

R4P36CN

Cage nut rails
84.0"H x 23.25"W x 36.0"D
45 rack spaces

R4P42CN

Cage nut rails
84.0"H x 23.25"W x 41.5"D
45 rack spaces

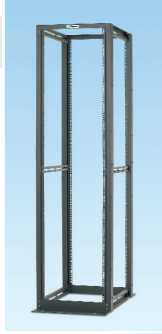

2 R4PFP

- Vertical Blanking Panel

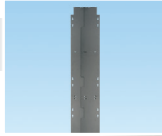

3 CVPDUB

- Vertical PDU Mounting Brackets



4 CVPPB

- Vertical Patch Panel Mounting Bracket



5 RCSTR

- Caster set



6 R4PFL

- Vertical finger section for cable management

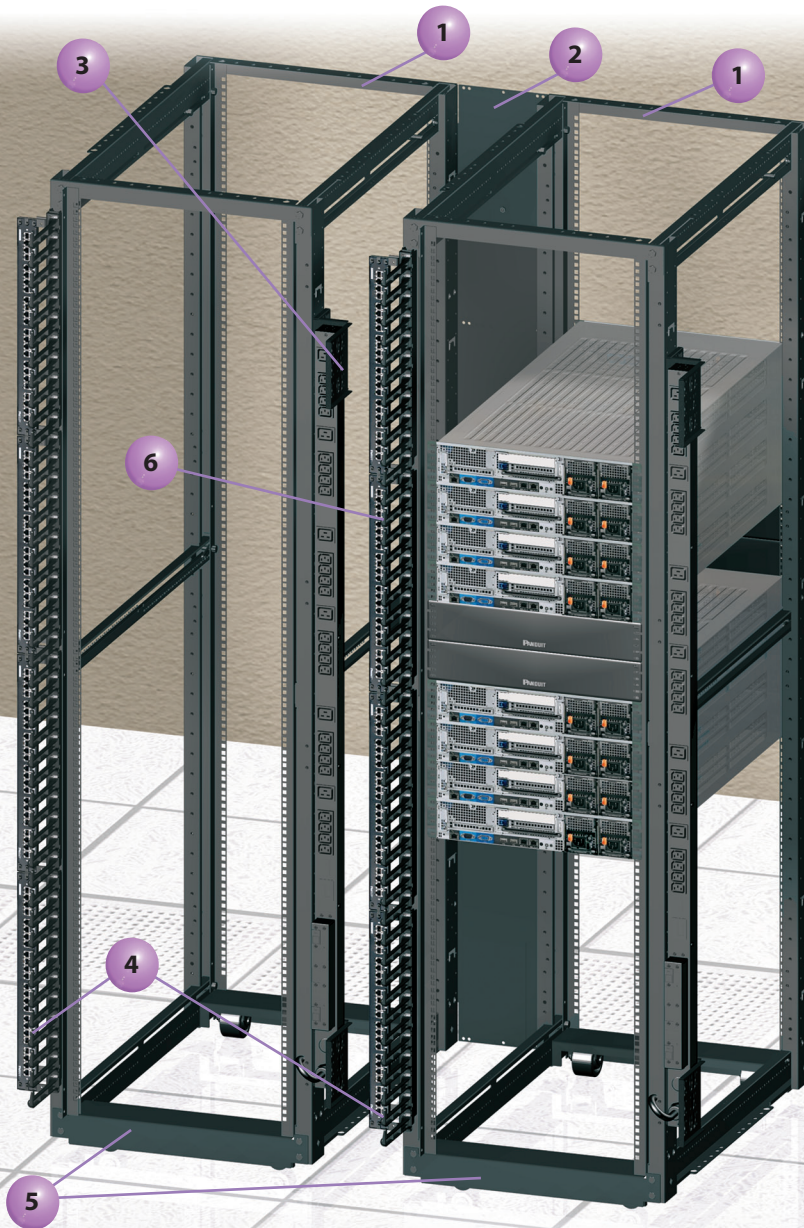
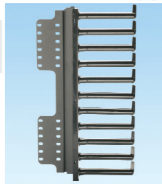

4 Post Rack System configured for server application.

4 Post Cable Management Rack System and Accessories

- Offered in 23", 30", 36" and 42" depths
- Offered in 84" and 96" heights
- Fully adjustable rails can be adjusted after rack is secured to floor

- Cage nut rails for server applications and tapped rails for switch applications
- 2,500 lbs. (1134 kg) load rating, UL Listed



R4P

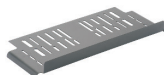

R4PWF



RSHLF



CVPPB



CNSPE



CVPDUB

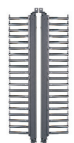

R4PFM



R4PAE1



R4PAE2



R4PAE3

Part Number	Part Description	No. of Rack Spaces‡	Std. Pkg. Qty.
4 Post Rack Threaded Rail			
R4P23*	Dimensions: 84.0"H x 23.25"W x 23.0"D (2134mm x 591mm x 584mm).	45	1
R4P*	Dimensions: 84.0"H x 23.25"W x 30.0"D (2134mm x 591mm x 762mm).	45	1
R4P36*	Dimensions: 84.0"H x 23.25"W x 36.0"D (2134mm x 591mm x 914mm).	45	1
R4P42*	Dimensions: 84.0"H x 23.25"W x 41.5"D (2134mm x 591mm x 1054mm).	45	1

4 Post Rack Accessories

R4PWF	Top trough with waterfall creates pathway above rack. Dimensions: 1.9"H x 26.1"W x 8.5"D (50mm x 662mm x 216mm).	—	1
RSHLF23	4 post rack mount shelf. Load rating 275 lbs.(124.7 kg). Dimensions: 1.7"H x 19.0"W x 23.0"D (44mm x 483mm x 584mm).	1	1
RSHLF	4 post rack mount shelf. Load rating 275 lbs. (124.7 kg). Dimensions: 1.7"H x 19.0"W x 30.0"D (44mm x 483mm x 762mm).	1	1
RSHLF36	4 post rack mount shelf. Load rating 275 lbs. (124.7 kg). Dimensions: 1.7"H x 19.0"W x 36.0"D (44mm x 483mm x 914mm).	1	1
R4PFP	Adjustable vertical filler panel for Panduit 4 Post Racks blocks by-pass air and directs cold airflow through equipment when used.	45	1
RCSTR	4 post rack casters.	—	1
CVPPB	Bracket to vertically mount 1 RU EIA 19" copper and fiber patch panels to the side of the Net-Access™ Cabinet posts or 4 post racks.	—	1
CNSPE	Net-Access™ Network Cabinet and 4 post rack end channel slack spools. Package includes one left and one right slack spool and mounting brackets.	—	1
CVPDUB	Bracket for vertical PDU mounting to the side of the Net-Access™ Cabinet posts or 4 post racks (kit of two).	—	1
R4PFL	Left vertical finger section for cable management.	11	1
R4PFR	Right vertical finger section for cable management.	11	1
R4PFM	Finger managers for 7 and 8 foot Panduit 4 Post Racks.	—	1

Thermal Ducts for 4 Post Racks

R4PAE1	Panduit 4 post rack thermal duct for use with Cisco^ 6509, 6509E, 6513, 9513 Director and Juniper 8208 switches.	—	1
R4PAE2	Panduit 4 post rack thermal ducting for use with Cisco^ 7018 switch.	—	1
R4PAE3	Panduit 4 post rack thermal ducting for use with Cisco^ 7009 switch.	—	1

*For 7' 4 Post Rack Cage Nut Rail add suffix CN to the end of the part number, for example, R4P23CN.

NOTE: For 8' 4 Post Rack Threaded Rail, add suffix 96 to the end of the part number, for example, R4P2396. For 8' 4 Post Rack Cage Nut, add suffix CN96 to the end of the part number, for example, R4P23CN96.

^Cisco is a registered trademark of Cisco Technology Inc.

**Juniper Networks and the Juniper Networks logo are registered trademarks of Juniper Networks, Inc. in the United States and other countries.

‡One rack space = 1.75" (44.45mm).

All product color is black.

2 Post Rack System

- Offered in 84" (2134mm) and 96" (2441mm) versions for both the three inch deep channel rack and six inch deep channel rack
- Rack space identification is printed numbers up allowing quick and easy equipment installation and identification
- Fully bonded structure
- 3" (76mm) deep channel, 1000 lb. (454 kg) load rating, UL listed
- 6" (152mm) deep channel, 1500 lb. (680 kg) load rating, UL listed
- Perforated rails for cable access and side-to-side airflow switches [6" (152mm) depth only]



Part Number	Part Description	No. of Rack Spaces‡	Std. Pkg. Qty.
3" Deep Channel Rack			
R2P	19" EIA rack, aluminum. Dimensions: 84.0"H x 20.3"W x 3.0"D (2134mm x 514mm x 76mm).	45	1
R2P96	19" EIA rack, aluminum. Dimensions: 96.0"H x 20.3"W x 3.0"D (2134mm x 514mm x 76mm).	52	1
R2PS	19" EIA rack, steel. Dimensions: 84.0"H x 20.3"W x 3.0"D (2134mm x 514mm x 76mm).	45	1
R2PW	23" EIA rack, aluminum. Dimensions: 84.0"H x 24.3"W x 3.0"D (2134mm x 616mm x 76mm).	45	1
R2P48	19" EIA rack, aluminum. Dimensions: 48.0"H x 20.3"W x 3.0"D (1219mm x 514mm x 76mm).	24	1
S1224-C	#12-24 x .5" mounting screws.	—	100
6" Deep Channel Rack			
R2P6S	19" EIA rack, 6" channel, steel. Dimensions: 84.0"H x 20.3"W x 6"D (2134mm x 514mm x 152mm).	45	1
R2P6S96	19" EIA rack, 6" channel, steel. Dimensions: 96.0"H x 20.3"W x 6"D (2438mm x 514mm x 152mm).	52	1
R2PPEVWF	Waterfall Trough for 2 Post Rack and PatchRunner™ High Capacity Vertical Cable Managers.	—	1
Thermal Duct for 2 Post Racks			
R2PAE1	2 post rack thermal duct for use with Cisco^ 6509 and 6509E Catalyst switches.	—	1
R2PAE2	2 post rack thermal duct for use with Cisco^ 7009 switch.	—	1
Accessories			
RFAKIT	Rack anchor kit for concrete floor (set of four).	—	1
R2PPDUB	Power Outlet Unit (POU) bracket for 2 and 4 post racks (set of two).	—	1

‡One rack space = 1.75" (44.45mm).

^Cisco is a registered trademark of Cisco Technology Inc..

All product color is black.

High Capacity Horizontal Cable Management Systems

NetManager™ High Capacity Horizontal Cable Managers

- Innovative inset fingers slope inward toward back of managers offering unobstructed access to network cabling for easier moves, adds, and changes
- Large front finger openings easily accommodate Category 6A and Category 6 cables, speeding installation and reducing maintenance costs
- Rear cable management finger spacing utilizes open D-rings for greater accessibility
- Can be used to create large capacity horizontal pathways for routing cable
- Front and rear dual hinged cover allows cable access without removing cover
- Built in cable retainers hold cable in place for easy moves, adds, and changes

Part Number	Part Description	No. of Rack Spaces‡	Cable Capacity		Std. Pkg. Qty.
			Cat.6A (0.300")	Cat.6 (0.240")	

19" High Capacity Manager, Front and Rear

NM1	1 RU. 1.7"H x 19.0"W x 13.1"D (44mm x 482mm x 332mm).	1	18/18	30/30	1
NM2	2 RU. 3.5"H x 19.0"W x 13.1"D (88mm x 482mm x 332mm).	2	54/54	84/84	1
NM3	3 RU. 5.2"H x 19.0"W x 13.1"D (133mm x 482mm x 332mm).	3	90/90	144/144	1
NM4	4 RU. 7.0"H x 19.0"W x 13.1"D (177mm x 482mm x 332mm).	4	132/132	210/210	1

19" High Capacity Manager, Front Only

NMF1	1 RU. 1.7"H x 19.0"W x 6.2"D (44mm x 482mm x 157mm).	1	18	30	1
NMF2	2 RU. 3.5"H x 19.0"W x 6.2"D (88mm x 482mm x 157mm).	2	54	84	1
NMF3	3 RU. 5.2"H x 19.0"W x 6.2"D (133mm x 482mm x 157mm).	3	90	144	1
NMF4	4 RU. 7.0"H x 19.0"W x 6.2"D (177mm x 482mm x 157mm).	4	132	210	1

Accessories

NM1B	Front to rear pass through blanking panel for NetManager™ High Capacity Horizontal Cable Managers, NM1 and NMF1.	—	—	—	1
NM2B	Front to rear pass through blanking panel for NetManager™ High Capacity Horizontal Cable Managers, NM2 and NMF2.	—	—	—	1
NM3B	Front to rear pass through blanking panel for NetManager™ High Capacity Horizontal Cable Managers, NM3 and NMF3.	—	—	—	1
NM4B	Front to rear pass through blanking panel for NetManager™ High Capacity Horizontal Cable Managers, NM4 and NMF4.	—	—	—	1

Capacities are based on a fill ratio of 40% to accommodate proper cable routing techniques. For 50% fill ratio, multiply by 1.25.

Multiply Category 6A capacity by 1.5 for fill ratio when using Panduit® Category 6A-SD cable.

‡One rack space = 1.75" (44.45mm).

All product color is black.



NM2



NMF2



NMF3



NMF4

PatchRunner™ High Capacity Horizontal Cable Managers

- Adjustable depth for pathway utilization or fan avoidance cable crossover
- Manage cables on switches with vertical cards
- Can be used to create cable pathways for routing cable
- Steel hinged cover provides easy access to pathway

Part Number	Part Description	No. of Rack Spaces‡	Cable Capacity		Std. Pkg. Qty.
			Cat6.A (0.300")	Cat.6 (0.240")	

PEHF2	3.5"H x 18.9"W x 9.8"D* (89mm x 480mm x 250mm*)	2	92	143	1
PEHF3	5.2"H x 18.9"W x 9.8"D* (133mm x 480mm x 250mm*)	3	166	259	1
PEHF4	7.0"H x 18.9"W x 9.8"D* (177mm x 480mm x 250mm*)	4	240	375	1

*Depth can telescope from rack mounting face 4.4" (112mm) to 7.6" (193mm).

Capacities are based on a fill ratio of 40% to accommodate proper cable routing techniques. For 50% fill ratio, multiply by 1.25.

Multiply Category 6A capacity by 1.5 for fill ratio when using Panduit® Category 6A-SD cable.

‡One rack space = 1.75" (44.45mm).

All product color is black.



PEHF

Horizontal Cable Management Systems

PatchLink™ Horizontal Cable Managers

- Dual hinged cover allows cable access without removing cover
- Rounded edges on fingers protect cables from snags and damage to cable

- Flexible fingers allow easy installation and removal of cables
- Pass-through holes allow front to rear cabling
- Covers, #12-24 and M6 mounting screws included
- Bulk package options minimize packaging on-site



WMPSE



WMPSE-X



WMP1E



WMP1E-V

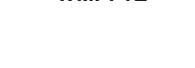

WMPFSE



WMPF1E

Part Number	Part Description	No. of Rack Spaces‡	Cable Capacity		Std. Pkg. Qty.
			Cat.6 (0.240")	Cat.5e (0.225")	
19" Manager, Front and Rear					
WMPSE	1.7"H x 19.0"W x 8.9"D (44mm x 483mm x 226mm).	1	24/25	30/44	1
WMPSE-X		1			10
WMP1E	1.7"H x 19.0"W x 7.9"D (44mm x 483mm x 200mm).	1	12/13	16/44	1
WMP1E	3.5"H x 19.0"W x 8.9"D (89mm x 483mm x 226mm).	2	60/79	66/90	1
WMP1E-V		2			5
WMPH2E	3.5"H x 20.2"W x 8.9"D (89mm x 513mm x 226mm). Includes extended front covers and two bend radius clips.	2	60/59	66/66	1

19" Manager, Front Only

WMPFSE	1.7"H x 19.0"W x 3.7"D (44mm x 483mm x 94mm).	1	24	30	1
WMPFSE-E		1			20
WMP1E	1.7"H x 19.0"W x 2.7"D (44mm x 483mm x 69mm).	1	12	16	1
WMPF1E	3.5"H x 19.0"W x 3.7"D (89mm x 483mm x 94mm).	2	60	66	1
WMPF1E-X		2			10
WMPHF2E	3.5"H x 20.2"W x 3.7"D (89mm x 573mm x 94mm). Includes extended front covers and two bend radius clips.	2	60	66	1

Capacities are based on fill ratio of 40% to accommodate proper cable routing techniques. For 50% fill ratio, multiply by 1.25.

‡One rack space = 1.75" (44.45mm).

All product color is black.

NetManager™ Horizontal Cable Managers

- Removable front cover hinges 180° up or down to allow access without removing cover
- Pass-through holes allow for front to rear cabling

- Built in cable retainers hold cable in place for easy moves, adds, and changes
- Covers, #12-24 and M6 mounting screws included
- Curved finger surfaces designed to maintain bend radius for fiber and copper



NCMH2

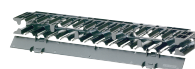

NCMHF1

Part Number	Part Description	No. of Rack Spaces‡	Cable Capacity			Std. Pkg. Qty.
			Cat.6 (0.240")	Cat.5e (0.225")	Fiber (3mm)	
19" Manager, Front and Rear						
NCMH2	3.5"H x 19.0"W x 9.8"D (88mm x 483mm x 248mm). Snap-on rear cover.	2	54/66	60/78	220/352	1
19" Manager, Front Only						
NCMHF1	1.7"H x 19.0"W x 3.7"D (44mm x 483mm x 95mm).	1	24	24	88	1
NCMHF2	3.5"H x 19.0"W x 3.7"D (88mm x 483mm x 95mm).	2	54	60	220	1

Capacities are based on a fill ratio of 40% to accommodate proper cable routing techniques. For 50% fill ratio, multiply by 1.25.

‡One rack space = 1.75" (44.45mm).

All product color is black.

Open-Access™ Horizontal Cable Managers

- D-ring managers provide an open and efficient way to manage power, coaxial, and communications cables
- Optional snap-on cover
- Optional front and rear managers
- Pass-through holes allow front to rear cabling
- Hardware included



CMPHF1



CMPHHF1



CMPHF2



CMPHH2

Part Number	Part Description	No. of Rack Spaces‡	Cable Capacity		Std. Pkg. Qty.
			Cat.6 (0.240")	Cat.5e (0.225")	
19" Manager, Front Only					
CMPHF1	1.7"H x 19.0"W x 3.4"D (44mm x 483mm x 87mm).	1	24	24	1
CMPHHF1	1.7"H x 19.0"W x 5.7"D (44mm x 483mm x 144mm).	1	24	30	1
CMPHF2	3.5"H x 19.0"W x 3.4"D (88mm x 483mm x 87mm).	2	54	60	1
CMPHH2	3.5"H x 19.0"W x 5.7"D (88mm x 483mm x 144mm).	2	96	108	1

Capacities are based on a fill ratio of 40% to accommodate proper cable routing techniques. For 50% fill ratio, multiply by 1.25.

‡One rack space = 1.75" (44.45mm).

All product color is black.

Rack Mount Shelves for 2 Post Racks

- Load ratings up to 250 lbs.; refer to part descriptions for specific load ratings

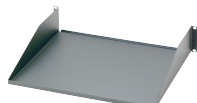

SRM19FM2

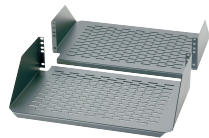

SRM19CMV3

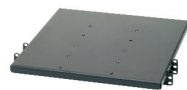

SRM19X18A1

Part Number	Part Description	No. of Rack Spaces‡	Std. Pkg. Qty.
SRM19FM1	19" front mount shelf, steel. Dimensions: 1.7"H x 19.0"W x 15.2"D (44mm x 483mm x 385mm). Load rating 30 lbs. (13.6 kg).	1	1
SRM19FM2	19" front mount shelf, steel. Dimensions: 3.5"H x 19.0"W x 15.2"D (88mm x 483mm x 385mm). Load rating 50 lbs. (22.7 kg).	2	1
SRM19CMV3	19" cantilevered shelf, vented aluminum. Includes two-piece shelf that mounts to front and back of EIA racks. Dimensions: 5.2"H x 19.2"W x 12.5"D (133mm x 489mm x 316mm). Load rating 200 lbs. (90.9 kg).	3	1
SRM19CM3	19" cantilevered shelf, aluminum. Includes two-piece shelf that mounts to front and back of EIA racks. Dimensions: 5.2"H x 19.2"W x 12.5"D (133mm x 489mm x 316mm). Load rating 200 lbs. (90.9 kg).	3	1
SRM19X18A1	19" adjustable mount shelf, steel, mounts to front and back of EIA racks. Dimensions: 1.8"H x 19.0"W x 18.0"D (44mm x 483mm x 457mm). Load rating 250 lbs. (113.6 kg).	1	1
SRM19X25A1	19" adjustable mount shelf, steel, mounts to front and back of EIA racks. Dimensions: 1.8"H x 19.0"W x 25.0"D (44mm x 483mm x 635mm). Load rating 250 lbs. (113.6 kg).	1	1

‡One rack space = 1.75" (44.45mm).

All product color is black.

Tool-Less Blanking Panels

- Minimize bypass airflow in racks and cabinets while providing an aesthetic appearance



TLBP1



TLBP2

Part Number	Part Description	No. of Rack Spaces‡	Std. Pkg. Qty.
TLBP1S-V	19" (483mm) width for 3/8" cage nut holes.	1	5
TLBP2S-V	19" (483mm) width for 3/8" cage nut holes.	2	5
TLBP1R-V	19" (483mm) width for tapped rails.	1	5
TLBP2R-V	19" (483mm) width for tapped rails.	2	5

‡One rack space = 1.75" (44.45mm).

All product color is black.

PatchRunner™ High Capacity Vertical Cable Manager

Specifications

- Dual-sided cable managers, having 60% of total cable capacity on one side and 40% on the other, allow optimized capacity placement on either side of the rack
- Cable managers have multiple mounting locations to the side of the rack, allowing optimal cable routing and space utilization
- When using a dual-sided cable manager in an inter-connect network architecture, the 60% side of the cable manager can be orientated towards the patching side of the rack to manage a higher number of patch cords
- When using a dual-sided cable manager in a cross-connect network architecture, the 60% side of the cable manager can be orientated towards the cabling side of the rack to manage a higher number of cables

Part Number	60% Capacity Channel					40% Capacity Channel					RU Capacity	
	Channel Area (In. ²)	Cat.6A-SD (0.240")	Cat.6A (0.300")	Cat.6 (0.240")	Cat.5e (0.225")	Area (In. ²)	Cat.6A-SD (0.240")	Cat.6A (0.300")	Cat.6 (0.240")	Cat.5e (0.225")	Total	
PEV6 (dual-sided) PEVF6 (single-sided)	64.8	531	340	531	605	46.2	357	228	357	406	3 rows of 2 RU	6
PEV8 (dual-sided) PEVF8 (single-sided)	83.4	733	469	733	834	65	501	320	501	570	3 rows of 3 RU	9
PEV10 (dual-sided) PEVF10 (single-sided)	121	936	599	936	1065	83.4	644	412	644	733	3 rows of 4 RU	12
PEV12 (dual-sided) PEVF12 (single-sided)	147	1137	728	1137	1294	102	789	505	789	897	3 rows of 6 RU (6 with limited depth)	12/18

*Capacities are based on a fill ratio of 35% to accommodate proper cable routing techniques. For 50% fill ratio, multiply by 1.5. Multiply Category 6A capacity by 1.5 for fill ratio when using Panduit Category 6A-SD cable. All dimensions represent typical outer cable diameter in inches (mm).

4 Post Rack

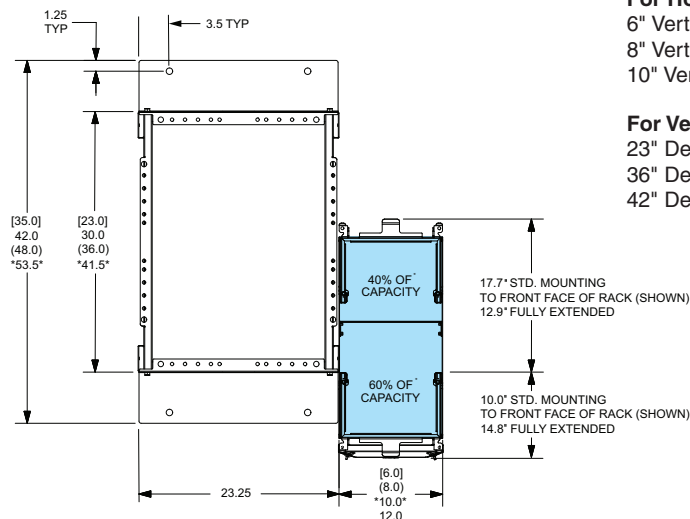

For Horizontal Dimensions:

6" Vertical Manager dimensions shown in brackets [...]
8" Vertical Manager dimensions shown in parenthesis (...)
10" Vertical Manager dimensions shown in Asterisk*...*

For Vertical Dimensions:

23" Deep 4 Post Rack dimensions shown in brackets [...]
36" Deep 4 Post Rack dimensions shown in parenthesis (...)
42" Deep 4 Post Rack dimensions shown in Asterisk*...*

2 Post Rack

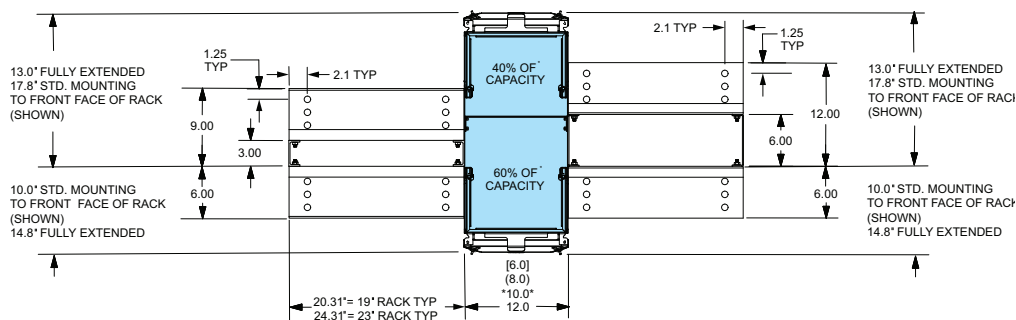

NetRunner™ High Capacity Vertical Cable Manager

Specifications

- NetRunner™ High Capacity Vertical Cable Managers are specifically designed for cable capacities typically found in telecommunication rooms using medium to large enterprise switches
- Optional strain relief bars can be mounted vertically inside the cable managers to create distinct pathways to better manage multiple types of network media

Capacity Chart	Front Channel with Slack Spool					Front Channel with No Slack Spool					Rear Channel				
	Channel Area (In ²)	Cable Capacity*				Channel Area (In ²)	Cable Capacity*				Channel Area (In ²)	Cable Capacity*			
		Cat.6A-SD (0.240")	Cat.6A (0.300")	Ca.t6 (0.240")	Cat.5e (0.225")		Cat.6A-SD (0.240")	Cat.6A (0.300")	Cat.6 (0.240")	Cat.5e (0.225")		Cat.6A-SD (0.240")	Cat.6A (0.300")	Cat.6 (0.240")	Cat.5e (0.225")
Part Number															
NRV6 (front/rear)	23.3	180	115	180	205	32.9	254	163	254	289	32.9	254	163	254	289
NRVF6 (front only)	23.3	180	115	180	205	32.9	254	163	254	289	—	—	—	—	—
NRV10 (front/rear)	42.8	331	212	331	377	52.4	406	260	406	461	52.4	406	260	461	461
NRVF10 (front/only)	42.8	331	212	331	377	52.4	406	260	406	461	—	—	—	—	—
NRV12 (front/rear)	54.6	422	270	422	481	64.2	497	318	497	565	64.2	497	318	565	565
NRVF12 (front only)	54.6	422	270	422	481	64.2	497	318	497	565	—	—	—	—	—

*Capacities are based on a fill ratio of 35% to accommodate proper cable routing techniques. For 50% fill ratio, multiply by 1.5. Multiply Category 6A capacity by 1.5 for fill ratio when using Panduit Category 6A-SD cable. All dimensions represent typical outer cable diameter in inches (mm).

4 Post Rack

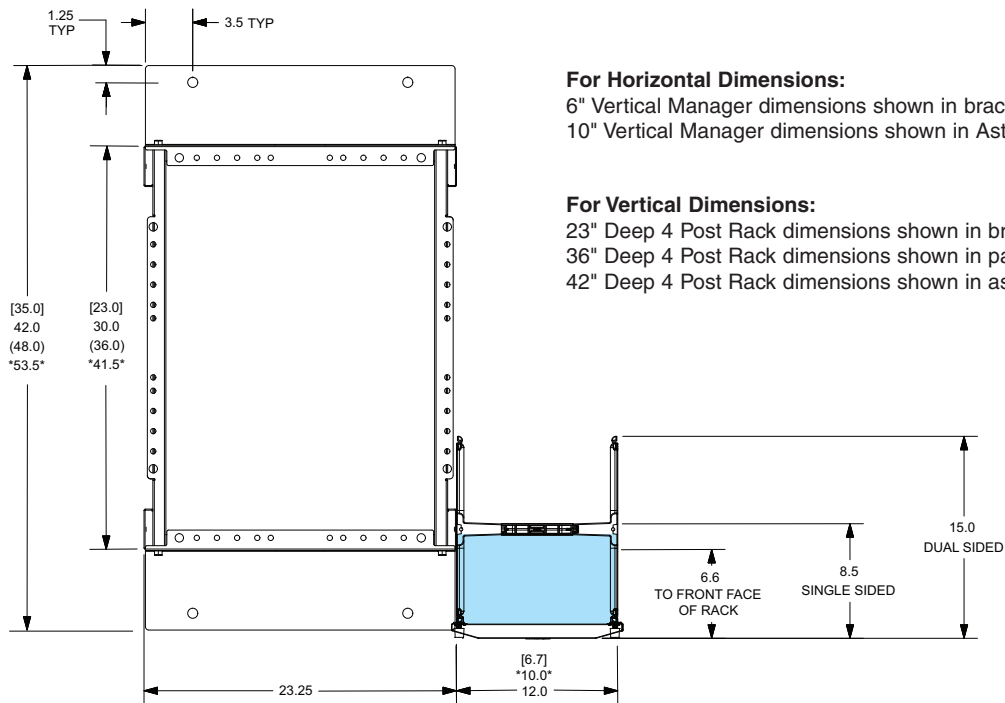

2 Post Rack

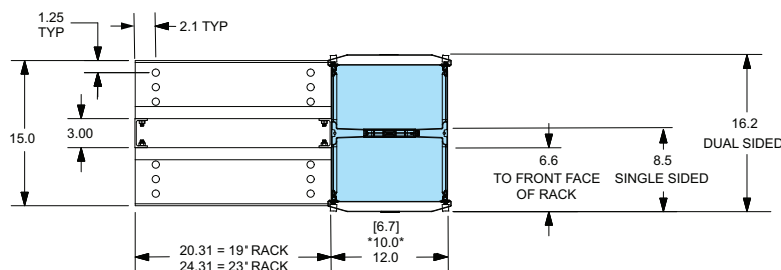

Real-World Solutions

With a proven reputation for excellence and innovation, Panduit and our partners work with you to overcome challenges and implement real-world solutions that create a competitive business advantage. Panduit offers the broadest range of solutions, from data centers and intelligent buildings to manufacturing operations, to help you build a **smarter, unified business foundation**.



Technology Leadership

Panduit develops innovative physical infrastructure solutions that meet the rapidly changing needs of our clients, from hardware and software to advisory services. This commitment is supported by investment in advanced research, solutions-focused product development, world-class manufacturing, and collaboration with customers at the forefront of technology.



Partner Ecosystem

Our best-in-class partner ecosystem offers a comprehensive portfolio of services that span the project lifecycle, from planning and design to delivery, deployment, maintenance, and operation. Panduit business partners – distributors, and certified architects, consultants, engineers, designers, system integrators, and contractors – are qualified to help you achieve your objectives and realize predictable and measurable results.



Strategic Alliances

Panduit cultivates long-term strategic alliances with industry leaders, including Cisco Systems, EMC, IBM, and Rockwell Automation, to develop, optimize, and validate solutions for our customers. This investment in people and resources helps solve our customers' greatest business challenges.



Global Business Commitment

Panduit is committed to delivering a consistently high level of quality and service the world over. With a presence in more than 100 countries, local Panduit sales representatives and technical specialists offer guidance and support that bring value to your business. Our global supply chain, which includes manufacturing, customer service, logistics, and distribution partners, provides prompt response to your inquiries and streamlines delivery to any worldwide destination.



Sustainability

With a commitment to environmental sustainability, Panduit develops and implements solutions that protect, replenish, and restore the world in which we live. This commitment is demonstrated by Panduit's LEED Gold certified World Headquarters, leveraging the Unified Physical InfrastructureSM approach to enable convergence of critical building systems to drive energy efficiency and ongoing operational improvement.

*Transform Your
Physical Infrastructure*

*Call or visit us online,
we can show you how.*

Panduit Corp.
World Headquarters
Tinley Park, IL 60487

cs@panduit.com
US and Canada: 800.777.3300
Europe, Middle East, and Africa:
44.20.8601.7200
Latin America: 52.33.3777.6000
Asia Pacific: 65.6305.7575

www.panduit.com

PANDUIT[®]