

THIS COPY IS PROVIDED ON A RESTRICTED BASIS AND IS NOT TO BE USED IN ANY WAY DETRIMENTAL TO THE INTERESTS OF PANDUIT CORP.

NOTES:

1. SEE CURRENT CATALOG FOR VARIOUS APPLICATIONS AND TO INDICATE PACKAGE QUANTITY.
2. 110 CONNECTORS ON BOTH ENDS. THE PATCH CORDS CAN BE USED WITH PAN-PUNCH™ 110 CONNECTING BLOCKS.
3. FEATURES INCLUDE A CLEAR CAP TO ENSURE PROPER WIRE SEQUENCE AND CONNECTOR ORIENTATION. RETAINING CLIPS SECURE THE JACKET CLOSE TO THE POINT OF TERMINATION WHICH MINIMIZES WIRE UNTWISTING. INTEGRAL STRAIN RELIEF MINIMIZES STRESS ON WIRES DURING DISCONNECTION.
4. POLARIZED TO PREVENT REVERSE INSTALLATION TO CONNECTOR BLOCK.
5. CATEGORY 5 UNSHIELDED TWISTED PAIR CABLE WITH 24AWG STRANDED TINNED COPPER CONDUCTORS.
6. DIMENSIONS IN PARENTHESES ARE IN METRIC.

CONTACT	CABLE WIRE COLOR
1	WHITE/BLUE
2	BLUE
3	WHITE/ORANGE
4	ORANGE

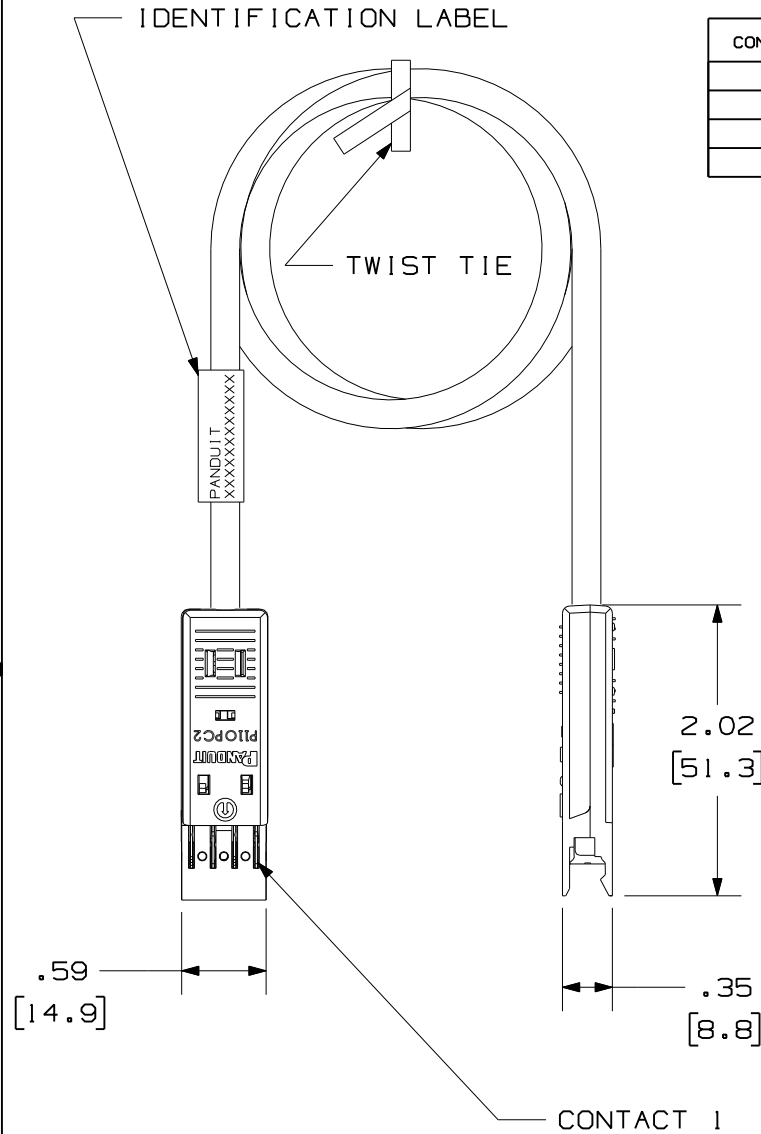

PANDUIT P/N	MIN. CABLE LENGTH	WEIGHT
P110PC21G2Y	2 FT.	.45 LB/10 PCS (210.8 g/10 PCS)
P110PC21G3Y	3 FT.	.57 LB/10 PCS (266.7 g/10 PCS)
P110PC21G4Y	4 FT.	.70 LB/10 PCS (322.6 g/10 PCS)
P110PC21G5Y	5 FT.	.82 LB/10 PCS (378.5 g/10 PCS)
P110PC21G6Y	6 FT.	.94 LB/10 PCS (434.4 g/10 PCS)
P110PC21G7Y	7 FT.	1.06 LB/10 PCS (490.3 g/10 PCS)
P110PC21G8Y	8 FT.	1.18 LB/10 PCS (546.2 g/10 PCS)
P110PC21G9Y	9 FT.	1.30 LB/10 PCS (602.1 g/10 PCS)
P110PC21G12Y	12 FT.	1.66 LB/10 PCS (769.8 g/10 PCS)
P110PC21G15Y	15 FT.	2.02 LB/10 PCS (937.5 g/10 PCS)
P110PC21G18Y	18 FT.	2.38 LB/10 PCS (1093.5 g/10 PCS)
P110PC21G.5MY	.5M	.41 LB/10 PCS (190.7 g/10 PCS)
P110PC21G1MY	1M	.61 LB/10 PCS (282.4 g/10 PCS)
P110PC21G1.5MY	1.5M	.81 LB/10 PCS (374.1 g/10 PCS)
P110PC21G2MY	2M	1.00 LB/10 PCS (465.8 g/10 PCS)
P110PC21G3MY	3M	1.40 LB/10 PCS (649.2 g/10 PCS)
P110PC21G4MY	4M	1.79 LB/10 PCS (832.6 g/10 PCS)
P110PC21G5MY	5M	2.21 LB/10 PCS (1027.2g/10 PCS)
P110PC21G6MY	6M	2.58 LB/10 PCS (1199.4g/10 PCS)

SIZE
A

DRAWING FILENAME: M02479JR_DC254_00A.PRT
 TITLE: CATEGORY 5 110 PATCHCORD CUSTOMER DRAWING

<p>PANDUIT^R CORP. TINLEY PARK, IL 60477</p>	I.I. NUMBER
	PRODUCT SPEC
<p>THIRD ANGLE PROJECTION</p>	WORK INSTRUCTION
	SCALE: NONE
DRAWN BY: NER	PART NO.: P110PC2****Y
DATE: 3-20-06	DRAWING NO.: 02479-254
CHK'D	

REV	DATE	BY	CHK	DESCRIPTION	ECN	R	CUST	SUP	OTH
R	3-20-06	NER		RELEASED TO PRODUCTION.	02479-254				