

THIS COPY IS PROVIDED ON A RESTRICTED BASIS AND IS NOT TO BE USED IN ANY WAY DETRIMENTAL TO THE INTERESTS OF PANDUIT CORP.

PART NUMBER	SEE DETAIL	"A" +/- .062	"B"	MARKER ACROSS	TUBING COLOR	SEE STYLE	MARKERS PER ROLL
H050X044H1T	A	0.50 [12.70]	0.75 [19.10]	4	WHITE	A	2000
H075X044H1T	B	0.75 [19.10]	1.00 [25.40]	2			1000
H100X044H1T	C	1.00 [25.40]	0.75 [19.10]	2			1000
H150X044H1T	D	1.50 [38.10]	1.00 [25.40]	1			500
H200X044H1T	E	2.00 [50.80]	0.75 [19.10]	1			500
H050X044H2T	A	0.50 [12.70]	0.75 [19.10]	4	YELLOW	A	2000
H075X044H2T	B	0.75 [19.10]	1.00 [25.40]	2			1000
H100X044H2T	C	1.00 [25.40]	0.75 [19.10]	2			1000
H150X044H2T	D	1.50 [38.10]	1.00 [25.40]	1			500
H200X044H2T	E	2.00 [50.80]	0.75 [19.10]	1			500
H050X044H3T	A	0.50 [12.70]	0.75 [19.10]	4	BLACK	A	2000
H075X044H3T	B	0.75 [19.10]	1.00 [25.40]	2			1000
H100X044H3T	C	1.00 [25.40]	0.75 [19.10]	2			1000
H150X044H3T	D	1.50 [38.10]	1.00 [25.40]	1			500
H200X044H3T	E	2.00 [50.80]	0.75 [19.10]	1			500
H050X044H4T	A	0.50 [12.70]	0.75 [19.10]	4	RED	A	2000
H075X044H4T	B	0.75 [19.10]	1.00 [25.40]	2			1000
H100X044H4T	C	1.00 [25.40]	0.75 [19.10]	2			1000
H150X044H4T	D	1.50 [38.10]	1.00 [25.40]	1			500
H200X044H4T	E	2.00 [50.80]	0.75 [19.10]	1			500
H050X044H1T-B	A	0.50 [12.70]	0.75 [19.10]	4	WHITE	A	10000
H075X044H1T-B	B	0.75 [19.10]	1.00 [25.40]	2			5000
H100X044H1T-B	C	1.00 [25.40]	0.75 [19.10]	2			5000
H150X044H1T-B	D	1.50 [38.10]	1.00 [25.40]	1			2500
H200X044H1T-B	E	2.00 [50.80]	0.75 [19.10]	1			2500
H100X044H2T-B	C	1.00 [25.40]	0.75 [19.10]	2	YELLOW	B	5000

NOTES:
1. DIMENSIONS IN [] ARE IN MILLIMETERS.

STYLE A

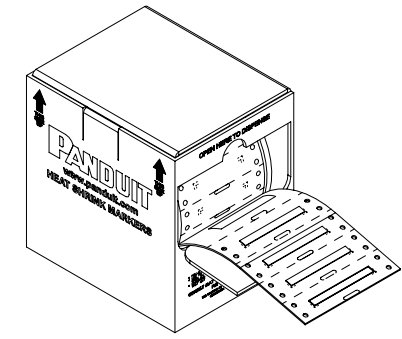
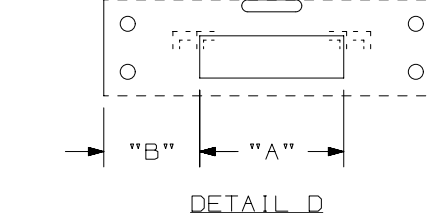
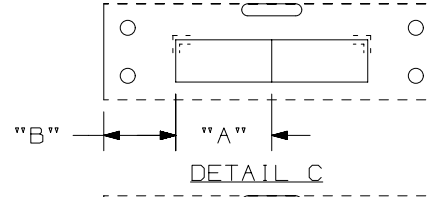
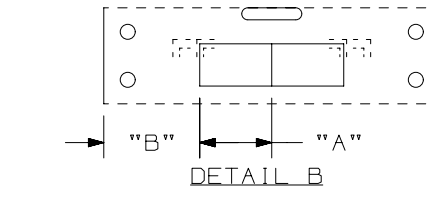
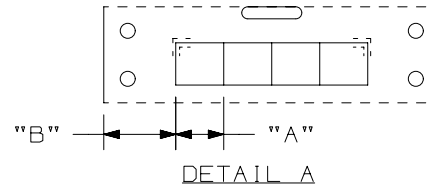

STYLE B

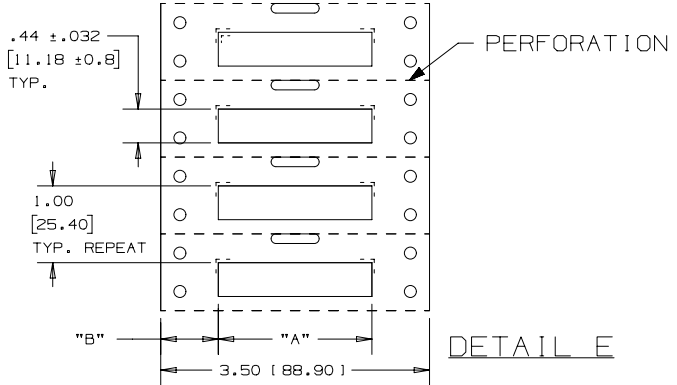
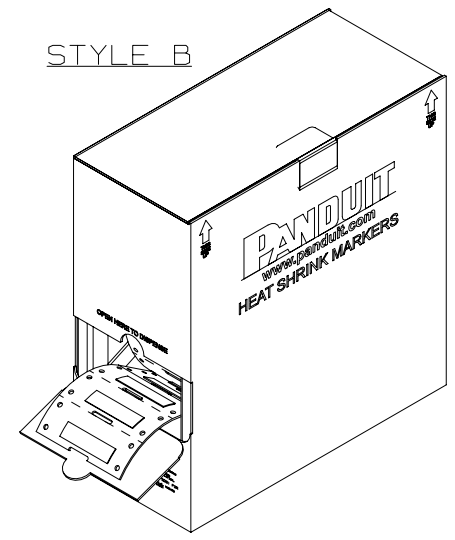

8
8

8

A

A

REV	DATE	BY	CHK	APR	DESCRIPTION	ECN
8	4/29/15	RVU	SEWH	JHAC	ADD NEW COLUMN OF MARKERS PER ROLL. MISSING PN: H075X044H2T AND H150X044H2T.	GAECN02782
7	1/20/15	RVU	SEWH	MSAD	REVISE OLD LOGO TO CURRENT PANDUIT LOGO.	GAECN02541
6	4/12/12	RVU			REVISED H150 PARTS TO SHOW ALL MARKERS ARE ONLY 1.5" LONG.	6731
5	5/21/09	RVU			+/- .12, +/- .062, +/- .020 WAS +/- .03, +/- .032, +/- .010. HT: .335 +/- .032 WAS .335. MAT'L, HSK TUBING GMUHS31, 3.5 LINER WAS GMUHS. ADD "A" +/- .062. ADD STYLE B VIEW FOR BULK BOX. ADD H100X044H2T-B ON TABLE. VIEWS UPDATE.	5593

TITLE H***X044H** OPTIMUM COMPUTER PRINTABLE MIL. SPEC. HEAT SHRINK MARKERS CUSTOMER DRAWING					
ITEM REVISION NAME 100923NH/06	PANDUIT				
DATASET FILE NAME 100923NH_DC_C10434/06J					
UNLESS OTHERWISE SPECIFIED, DIMENSIONAL TOLERANCES ARE: IN [mm] .x ± .12 [3.05] .xxx ± .020 [0.508] .xx ± .062 [1.57] ANGLES ±	MATERIAL: HEATSHRINK TUBING GMUHS31, 3.5 WIDE LINER				
THIRD ANGLE PROJECTION	DRAWING NUMBER: C10434				
DRAWN BY RVU	DATE 8/1/06	CHK MSAD	SCALE NTS	SHT 1 OF 1	SIZE A