





SMT POWER INDUCTORS

Unshielded Drum Core - P0250NL Series



-  **Height:** 7.37mm Max
-  **Footprint:** 18.62mm x 15.14mm Max
-  **Current Rating:** up to 8.6A
-  **Inductance Range:** 1μH to 1030μH

Electrical Specifications @ 25°C — Operating Temperature -40°C to +130°C

Part ^{6,7} Number	Inductance @ I _{PK} A _{DC} (μH ± 15%)	I _{rated} ⁵ (A)	DCR (MAX) (mΩ)	Saturation Current (A) @ 25°C	Heating Current (A)
P0250.102NL	1.0	8.6	9	20.0	8.60
P0250.222NL	2.2	7.1	14	16.0	7.10
P0250.332NL	3.3	6.2	15	14.0	6.20
P0250.562NL	5.6	5.3	20	12.0	5.30
P0250.103NL	10	4.3	31	10.0	4.30
P0250.153NL	15	4.0	36	8.0	4.00
P0250.223NL	22	3.5	47	7.0	3.50
P0250.333NL	33	3.0	66	5.5	3.00
P0250.473NL	47	2.6	86	4.5	2.60
P0250.683NL	68	2.3	130	3.5	2.30
P0250.104NL	100	1.8	190	3.0	1.80
P0250.154NL	150	1.5	250	2.6	1.50
P0250.224NL	220	1.2	380	2.4	1.20
P0250.334NL	330	1.0	560	1.9	1.00
P0250.474NL	470	.82	850	1.4	0.82
P0250.684NL	680	.72	1100	1.2	0.72
P0250.105NL	1000	.56	1800	1.0	0.56

- NOTES:**
- The temperature of the component (ambient plus temperature rise) must be within the specified operating temperature range.
 - Inductance tested at 100kHz, 0.1 mV_{RMS}
 - Inductance drop = 10% typical at the saturation current.
 - ΔT = 40°C rise typical at the heating current.
 - The rated current is the lower of the saturation or heating current.
 - Optional Tape & Reel packaging can be ordered by adding a "T" suffix to the part number (i.e. P0250.102NL becomes P0250.102NLT). Pulse complies to industry standard tape and reel specification EIA481.
 - The "NL" suffix indicates an RoHS-compliant part number. Non-NL suffixed parts are not necessarily RoHS compliant, but are electrically and mechanically equivalent to NL versions. If a part number does not have the "NL" suffix, but an RoHS compliant version is required, please contact Pulse for availability.

Mechanical

Schematic

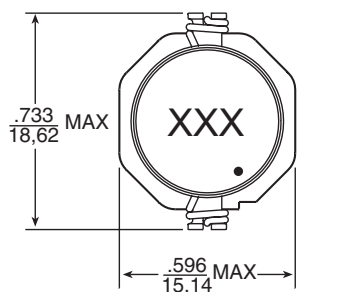

NOTE: Dot indicates start of winding

SUGGESTED PAD LAYOUT

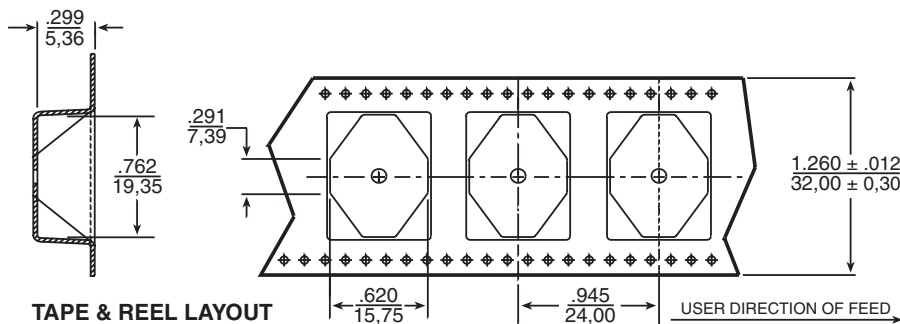
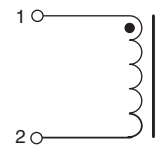
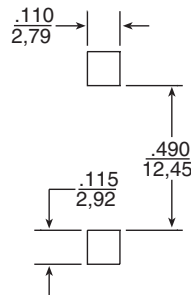

Weight 3.6 grams
Tape & Reel 250/reel

Dimensions: Inches
mm
Unless otherwise specified,
all tolerances are ± .010
0,25