

Features

LED DRIVER

- 60W Class II AC-DC LED Power Supply
- Constant Current Operation
- Power Factor Corrected
- Universal Input Voltage Range
- User Adjustable Current Limit (/OF)
- Thermal Feedback Dimming (/TOF)
- Waterproof Enclosure (/IP67)
- cUL/UL8750 Certified, CE Marked
- Class 2 Power Unit UL1310
- High Efficiency
- Long 5 Year Warranty

Description

The RACD60 is a compact universal input voltage 60W constant current power module suitable for driving high power LEDs. The RACD60 series have active power factor correction, universal input voltage range and are fully protected against output short circuit, overload and over-temperature. Three versions are available: a low cost open-frame with either internal (/OF) or external user-adjustable current limit (/TOF), and a sealed IP67 potted version (/IP67) with factory set output currents for outdoor or high humidity applications. The LED driver is a class II power supply with CSA, UL and CE certifications and comes with a five year warranty.

Selection Guide

Part Number	Output Voltage Range (min - max)**	Output Current Range (min - max)	Factory Set Current Limit	Efficiency (230VAC) Typ.	Output Power Range
RACD60-700*	38 - 54V	700 - 1100mA	0.7A	89%	27-60W
RACD60-1050*	38 - 54V	700 - 1100mA	1.0A	89%	27-60W
RACD60-1400*	21 - 28V	1400 - 2140mA	1.4A	89%	30-60W
RACD60-2100*	21 - 28V	1400 - 2140mA	2.1A	89%	30-60W
RACD60-2400*	17 - 24V	2150 - 2500mA	2.4A	87%	30-60W
RACD60-4200*	11 - 13.5V	3570 - 4200mA	4.2A	85%	40-60W

* use suffix /OF for open frame version (standard) - output current limit adjustable with on-board trimmer

* use suffix /TOF for open frame version with thermal feedback - output current limit externally adjustable.

* use suffix /IP67 for waterproof potted version - fixed output currents only

** adjustable output current range at potentiometer (only /OF types)

ordering examples:

RACD60-700/OF= open frame, adjustable current limit preset to 700mA.

RACD60-1050/TOF=open frame, 1050mA, adjustable 700-1050mA with ext. voltage or PWM signal.

RACD60-1400/IP67 = enclosed IP67 waterproof, non-adjustable 1400mA output.

Note: all currents within range are available - use RACD60-xxxx/IP67 where xxxx is the desired fixed current

e.g. RACD60-900/IP67 = enclosed IP67 waterproof, non-adjustable 900mA output.

Specifications (typical at 25°C and after warm up time unless otherwise specified)

Input Voltage Range	All Versions	90-264VAC
Rated Power		60 Watts max.
Input Frequency Range	All Versions	50/60 Hz
Power Factor Correction	Full Load, 115VAC/230VAC	> 0.9
THD	Full Load, 115VAC	17% max.
	Full Load, 230VAC	20% max.
Input Current (full load)	115VAC/230VAC	0.8A / 0.4A max.
Inrush Current (cold start)	115VAC/230VAC	25A / 50A max.
Leakage Current	230VAC/63Hz	<0.7mA max.
Input Fuse	Built-in	3.15A Slow Blow
Output Current Accuracy	Full load	±5%
Output Current Adjust	Preset Potentiometer (/OF)	75% to 100% approx.
	External Voltage (/TOF)	
Line Voltage Regulation	LL to HL at Full Load	±4% typ.
Load Voltage Regulation	60% to 100% Load	±5% typ.
Minimum Load Current		see table
Operating Frequency	All Versions	65kHz typ.

continued on next Page

LIGHTLINE
AC/DC-Converter
with 5 year Warranty

RECOM

60 Watt PFC
Single Output

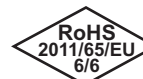

UL 8750 Certified
cUL 8750 Certified*
EN 61347 Certified

RACD60

* except 700mA/1100mA Versions

Input Voltage Derating (Ta=25°C)

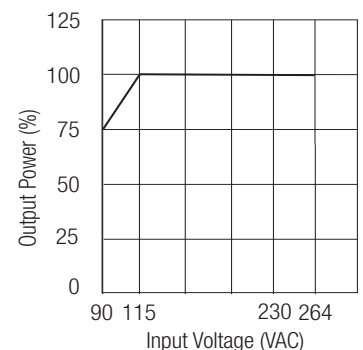

Note:

All LED Drivers may not be used without a load. They must be switched on the primary side only. Noncompliance may damage the LED or reduce its lifetime.

Refer to Application Notes

Specifications (typical at 25°C and after warm up time unless otherwise specified)

Efficiency at Full Load		see Selection Guide	
Isolation Voltage (60Hz RMS)	input to output	3.75kVAC / 1 minute	
	input to filter ground	1880VAC / 1 minute	
	output to filter ground	500VAC / 1 minute	
Temperature Coefficient	All Versions	±0.02%/°C typ.	
Overload Protection	All Versions	105% typ.	
Short Circuit Protection		Continuous, Hiccup, Automatic Restart	
Open Circuit Output Voltage (Zener Diode Clamp)	4200mA	19VDC	
	2400mA	25VDC	
Typical Values	2100mA/1400mA	29VDC	
	1050mA/700mA	55VDC	
Output Current Adjust (/TOF only)	External Voltage (1-10V)	10.5V max.	
	External PWM (10V)	300Hz max.	
Operating Temperature Range (refer to derating graphs)	free air convection, with derating	-30°C to +70°C	
	Case temperature (/IP67)	85°C max.	
Storage Temperature Range		-40°C to +85°C	
Humidity	non-condensing	95% RH max.	
Environmental Protection	Open Frame (/OF, /TOF)	Indoor Use Only	
	Potted Version (/IP67)	IP67	
PCB Material		Plastic Resin with Fibreglass (UL94V-0)	
Weight	Open Frame (/OF, /TOF)	165g	
	Potted Version (/IP67)	200g	
Packing Quantity		1pc	
EMC		EN 55015, EN61347-1, EN61347-2-13	
Harmonics		Certified to meet EN 61000-3-2 (Class C, Full load) and EN 61000-3-3	
MTBF (using MIL-HDBK-217F, 25°C)		583 x 10 ³ hours	
Safety Standards	LED Lighting Safety	Report: E34696	UL8750
	LED Lighting Safety (Canada)	Report: E34696	cUL8750
	Class 2 Power Supply Safety	Report: E34696	UL1310
	Extra Low-Voltage Class 2 Output	Report: E34696	CSA C22.2 No. 223-M91
	LED equipment for lighting application	Report: E34696	CSA C22.2 No. 250.13-12
	CE LVD Directive -all models		EN61347
Input/Output Connections	/OF Pin Header (suitable matching connector JST VHR or similar)	/IP67 340mm Cable ± 20mm	

RACD60

/TOF Output Current Adjustment

The /TOF offers the possibility to derate the output current with an external voltage or PWM signal.

Thermal feedback derating is an effective way to reduce the LED current at high temperatures to avoid over-stressing the LED.

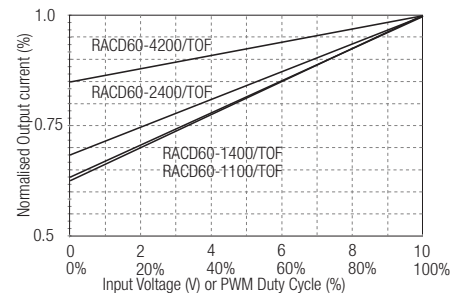

SIMPLE THERMAL FEEDBACK DIMMING CIRCUIT

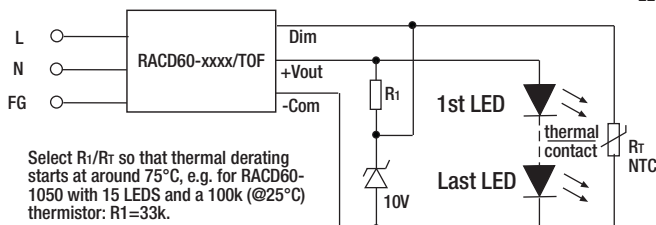

LED Current

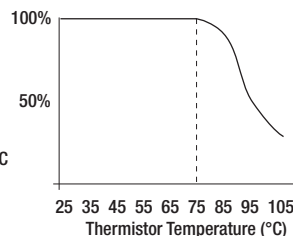

Typical Characteristics

Maximum Number of LED drivers per circuit breakers

Condition	Circuit Breaker	Circuit Breaker Current			
		10A	16A	20A	25A
115VAC, 10hm 90° phase angle	Typ				
	C	12	20	24	31
230VAC, 10hm 90° phase angle	B	13	21	25	32
	C	21	35	41	51
277VAC, 10hm 90° phase angle	B	15	24	29	37
	C	24	40	47	58

Package Style and Pinning

RACD60-xxxx/OF and RACD60-xxxx/TOF

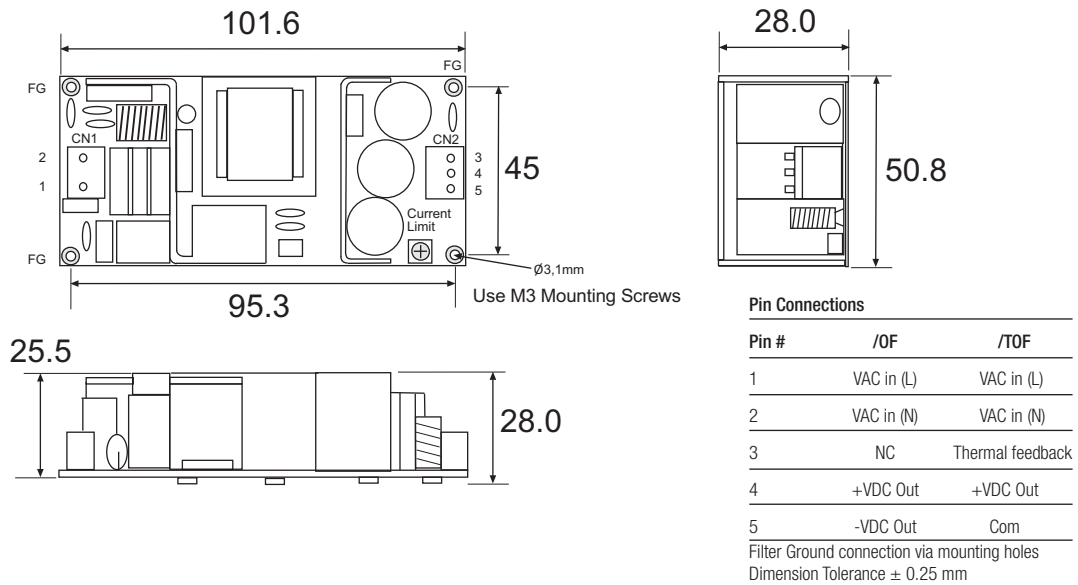

Package Style and Pinning

RACD60-xxxx/IP67

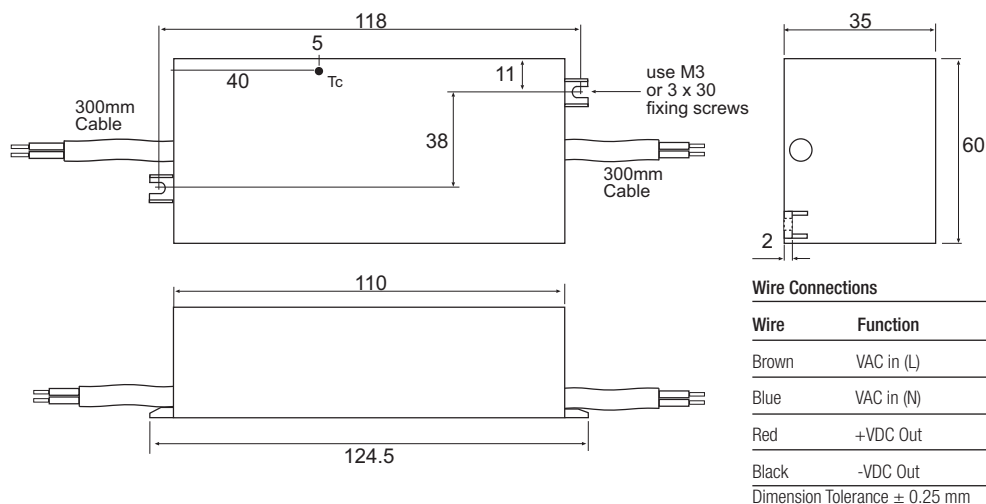

Derating Graphs

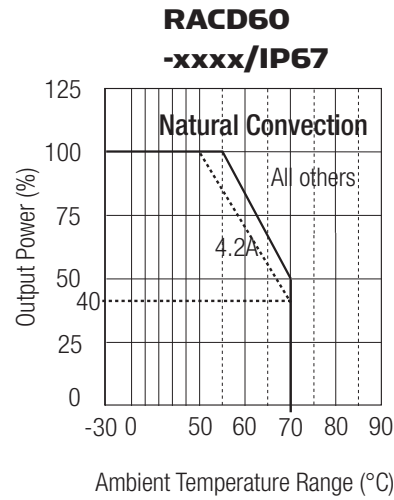
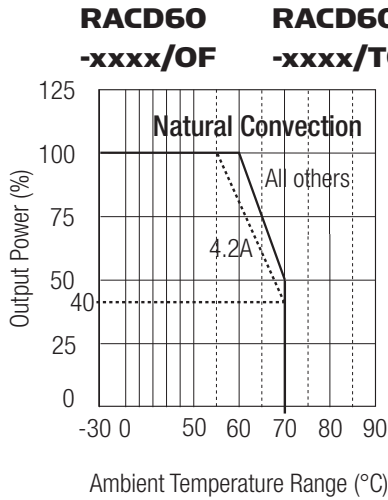

Application Information

LEDs are typically wired in series to make a string of LEDs and then the strings can be wired in parallel to generate enough light. If only two or three strings are wired in parallel then it is recommended to add resistors (e.g. 0.5R) to each string to help balance out the LED currents in each string. All strings must share a common heatsink for better current matching.

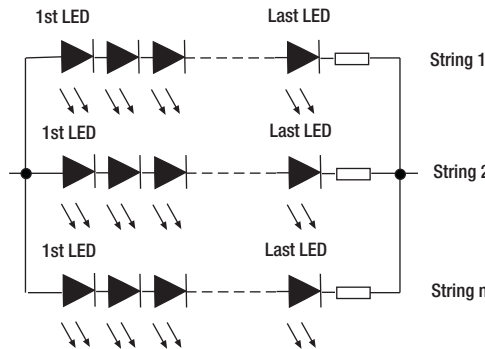

A typical 1W high brightness white LED has a forward voltage of around 3.3V at its operating temperature and draws 350mA. Thus each LED actually draws about 1.15W. Similarly, 3W white LEDs have usually the same forward voltage but can be run at 700mA or more. Using the LED datasheet specification, the optimum LED arrangement and the best driver for each application can be worked out.

The tables below show some examples. Other LED combinations may have different forward voltages at their recommended operating currents.

1W LEDs	LED Arrangement	AC/DC Driver
24	2 Strings of 12	RACD60-700
26	2 Strings of 13	RACD60-700
28	4 Strings of 7	RACD60-1400
30	3 Strings of 10	RACD60-1050
33	3 Strings of 11	RACD60-1050
35	5 Strings of 7	RACD60-2100
35	7 Strings of 5	RACD60-2400
36	3 Strings of 12	RACD60-1050
39	3 Strings of 13	RACD60-1050
42	3 Strings of 14	RACD60-1050
42	7 Strings of 6	RACD60-2400
42	14 Strings of 3	RACD60-4200
45	3 Strings of 15	RACD60-1050

3W LEDs	LED Arrangement	AC/DC Driver
12	12 in series	RACD60-700
14	2 Strings of 7	RACD60-1400
18	3 Strings of 6	RACD60-2100
18	6 Strings of 3	RACD60-4200

High Power LEDs	LED Arrangement	AC/DC Driver
Cree CXA2011	Single Array	RACD60-1050
Cree XM-L	6 in series	RACD60-2100
Lumiled Rebel	13 in series	RACD60-700
Osram Dragon	14 in series	RACD60-1050
Bridgelux RS	Single Array	RACD60-2100
Helieon	Single Module	RACD60-1400

The product information and specifications are subject to change without prior notice. RECOM products are not authorized for use in safety-critical applications (such as life support) without RECOM's explicit written consent. A safety-critical application is defined as an application where a failure of a RECOM product may reasonably be expected to endanger or cause loss of life, inflict bodily harm or damage property. The buyer shall indemnify and hold harmless RECOM, its affiliated companies and its representatives against any damage claims in connection with the unauthorized use of RECOM products in such safety-critical applications.