

Middle Power Class-D Speaker Amplifiers

Analog Input / BTL Output

Class-D Speaker Amplifier



BD5426MUV

No.10075EBT08

●Description

BD5426MUV is a 10W + 10W stereo class-D power amplifier IC, developed for space-saving and low heat-generation applications such as low-profile TV sets. The IC employs state-of-the-art Bipolar, CMOS, and DMOS (BCD) process technology that eliminates turn-on resistance in the output power stage and internal loss due to line resistances up to an ultimate level. With this technology, the IC has achieved high efficiency of 87% (9W + 9W output with 8Ω load), which is the top class in the industry. The IC, in addition, employs a compact back-surface heat radiation type power package to achieve low power consumption and low heat generation and eliminates necessity of installing an external radiator, up to a total output of 20W. This product satisfies both needs for drastic downsizing, low-profile structures and powerful, high-quality playback of the sound system.

●Features

- 1) A high efficiency of 87% (9W + 9W output with 8Ω load), which is the highest grade in the industry and low heat-generation.
- 2) An output of 10W + 10W (13V, with 8Ω load) is allowed without an external heat radiator.
- 3) Driving a lowest rating load of 6Ω is allowed.
- 4) Pop noise upon turning power on/off and power interruption has been reduced.
- 5) High-quality audio muting is implemented by soft-switching technology.
- 6) An output power limiter function limits excessive output to speakers.
- 7) High-reliability design provided with built-in protection circuits against high temperatures, against VCC shorting and GND shorting, against reduced-voltage, and against applying DC voltage to speaker.
- 8) A master/slave function allowing synchronization of multiple devices reduces beat noises.
- 9) Adjustment of internal PWM sampling clock frequencies (250 kHz to 400kHz) allows easy protective measures against unwanted radio emission to AM radio band.
- 10) A compact back-surface heat radiation type power package is employed.
VQFN048V7070 7.0mm × 7.0mm × 1.0mm, pitch 0.5mm

●Absolute maximum ratings

A circuit must be designed and evaluated not to exceed absolute maximum rating in any cases and even momentarily, to prevent reduction in functional performances and thermal destruction of a semiconductor product and secure useful life and reliability. The following values assume $T_a = 25^\circ\text{C}$. For latest values, refer to delivery specifications.

Parameter	Symbol	Ratings	Unit	Conditions
Supply voltage	VCC	+20	V	Pin 2, 14, 15, 22, 23, 38, 39, 46, 47 (Note 1, 2)
Power dissipation	Pd	3.28	W	(Note 3)
		4.8	W	(Note 4)
Input voltage for signal pin	VIN	-0.2 ~ +7.2	V	Pin 6, 7 (Note 1)
Input voltage for control pin	VCONT	-0.2 ~ Vcc+0.2	V	Pin 28, 32 (Note 1)
Input voltage for clock pin	VOSC	-0.2 ~ +7.2	V	Pin 31 (Note 1)
Operating temperature range	Topr	-40 ~ +85	°C	
Storage temperature range	Tstg	-55 ~ +150	°C	
Maximum junction temperature	Tjmax	+150	°C	

(Note 1) A voltage that can be applied with reference to GND (pins 5, 18, 19, 42, and 43)

(Note 2) Pd and $T_{jmax} = 150^\circ\text{C}$ must not be exceeded.

(Note 3) 114.3mm × 76.2mm × 1.6mm FR4 2-layer glass epoxy board (Copper Area 5505mm²) installed.

If used under $T_a = 25^\circ\text{C}$ or higher, reduce 26.2mW for increase of every 1°C. The board is provided with thermal via.

(Note 4) 114.3mm × 76.2mm × 1.6mm FR4 4-layer glass epoxy board (Copper Area 5505mm²) installed.

If used under $T_a = 25^\circ\text{C}$ or higher, reduce 38.4mW for increase of every 1°C. The board is provided with thermal via.

●Operating conditions

The following values assume $T_a = 25^\circ\text{C}$. Check for latest values in delivery specifications.

Parameter	Symbol	Ratings	Unit	Conditions
Supply voltage	VCC	+10 ~ +16.5	V	Pin 2, 14, 15, 22, 23, 38, 39, 46, 47
Load resistance	RL	6 ~ 16	Ω	(Note 5)

(Note 5) Pd should not be exceeded.

●Electrical characteristics

Except otherwise specified $T_a = 25^\circ\text{C}$, VCC = 12V, f_{IN} = 1kHz, R_g = 0 Ω , R_L = 8 Ω , MUTEX="H", MS="L"

For latest values, refer to delivery specifications.

Parameter	Symbol	Limits	Unit	Conditions
Whole circuit				
Circuit current 1 (Sampling mode)	ICC1	25	mA	With no signal
Circuit current 2 (Muting mode)	ICC2	10	mA	MUTEX = "L"
Control circuit				
"H" level input voltage	V _{IH}	2.3 ~ 12	V	SDX, MUTEX, MS
"L" level input voltage	V _{IL}	0 ~ 0.8	V	SDX, MUTEX, MS
Audio circuit				
Voltage gain	G _v	28	dB	P _o = 1W
Maximum output power 1 (Note 6)	PO1	9	W	THD+N = 10%
Maximum output power 2 (Note 6)	PO2	10	W	V _{cc} =13V, THD+N = 10%
Total harmonic distortion (Note 6)	THD	0.1	%	P _o = 1W, BW=20Hz ~ 20kHz
Crosstalk	CT	85	dB	P _o = 1W, R _g = 0 Ω , BW = IHF-A
Output noise voltage (Sampling mode)	V _{NO}	80	μVrms	R _g = 0 Ω , BW = IHF-A
Residual noise voltage (Muting mode)	V _{NOM}	1	μVrms	R _g = 0 Ω , BW = IHF-A, MUTEX = "L"
Internal sampling clock frequency	FOSC	250	kHz	MS = "L" (In master operation)

(Note 6) The rated values of items above indicate average performances of the device, which largely depend on circuit layouts, components, and power supplies. The reference values are those applicable to the device and components directly installed on a board specified by us.

●Electrical characteristic curves (Reference data)

(1) Under Stereo Operation($R_L=8\Omega$)

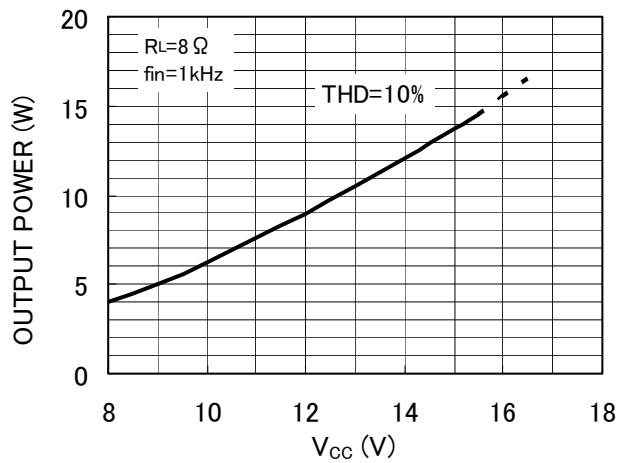
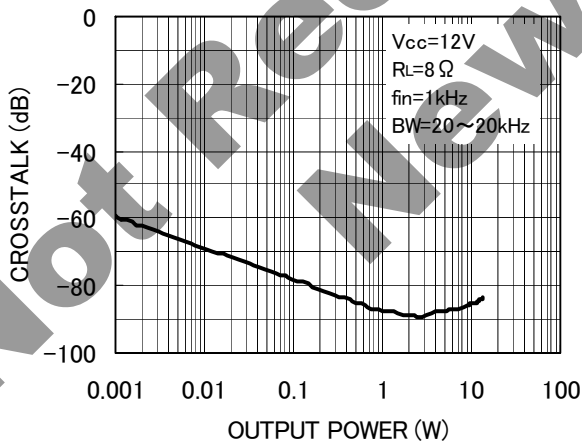
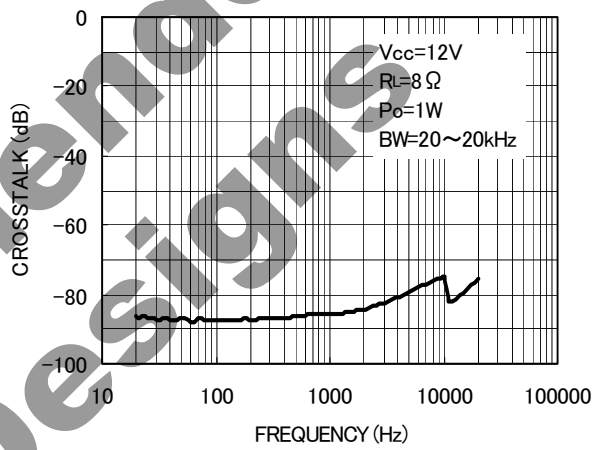
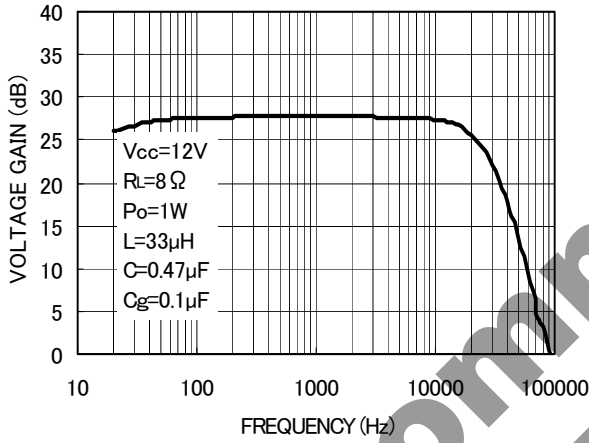
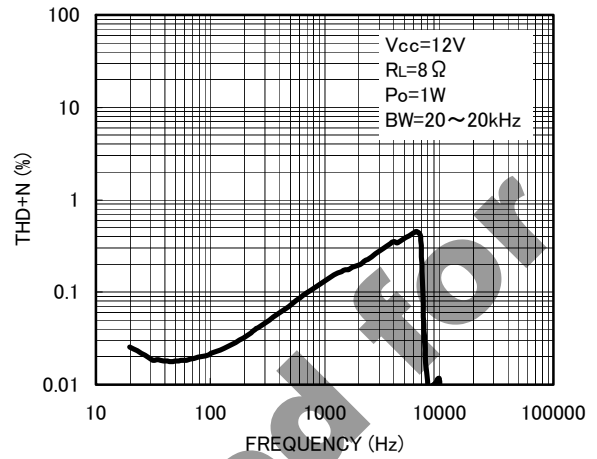
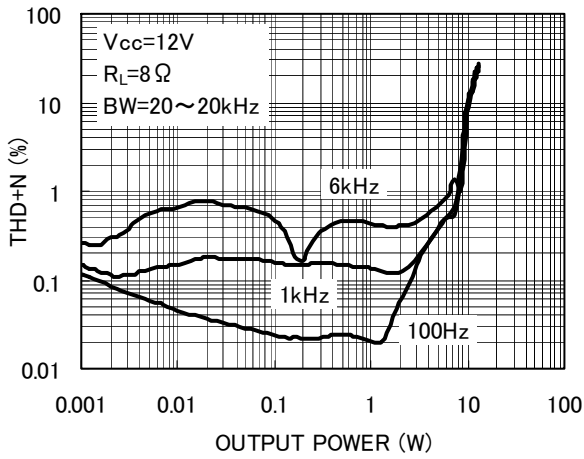

●Electrical characteristic curves (Reference data) – Continued

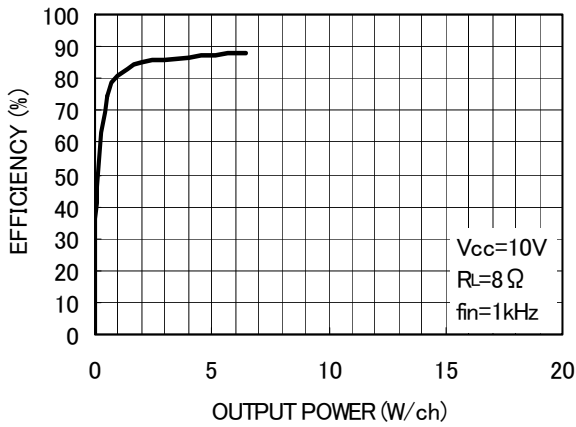

Fig. 7 Efficiency - Output power

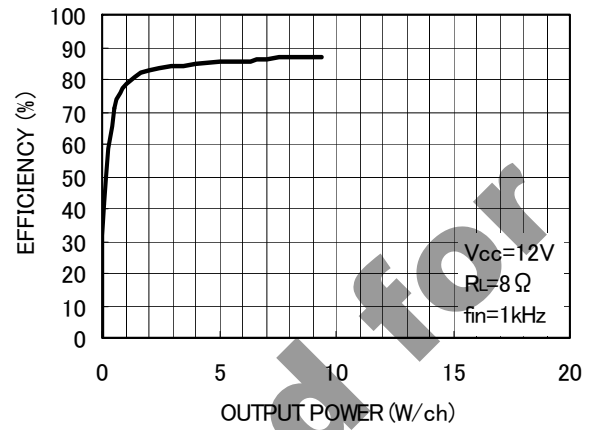

Fig. 8 Efficiency - Output power

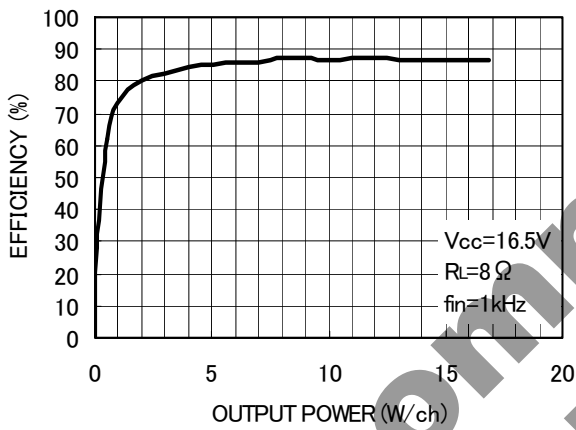

Fig. 9 Efficiency - Output power

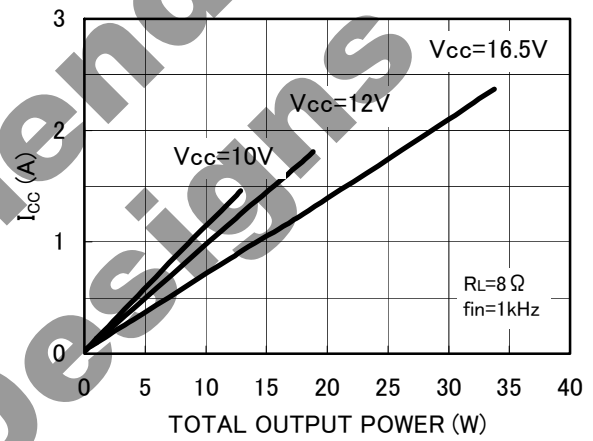

Fig. 10 Current consumption - Output power

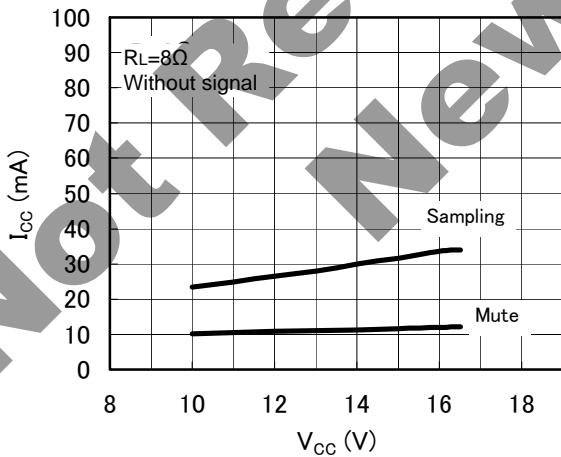

Fig. 11 Current consumption - Power supply voltage

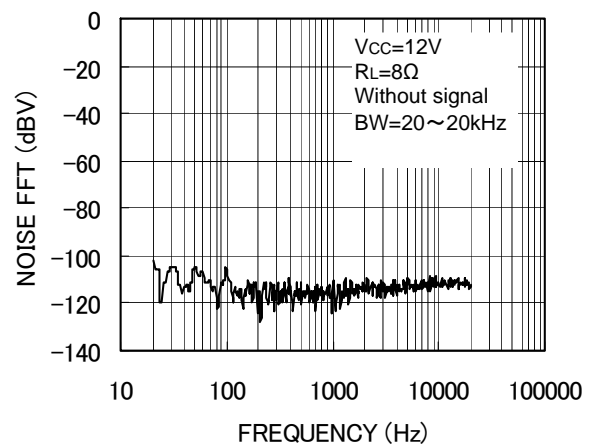

Fig. 12 FFT of Output Noise Voltage

●Electrical characteristic curves (Reference data) – Continued

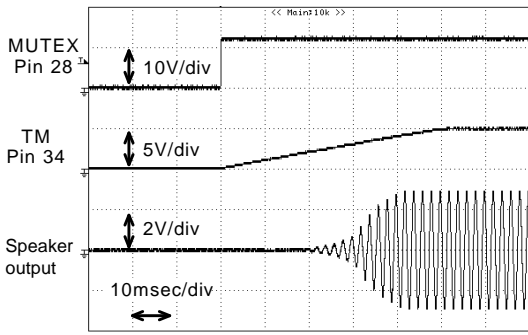

Fig. 13 Wave form when Releasing Soft-mute

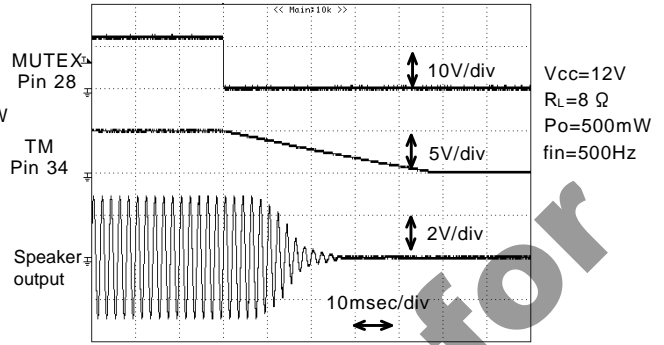

Fig. 14 Wave form when Activating Soft-mute

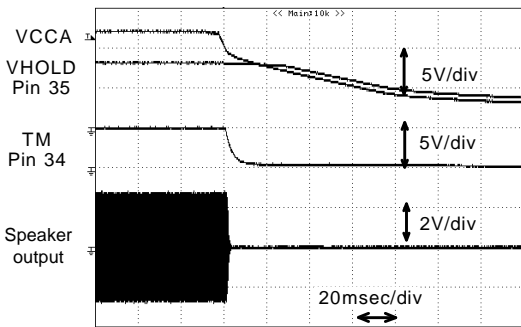

Fig. 15 Wave form on Instantaneous Power Interruption(20msec / div)

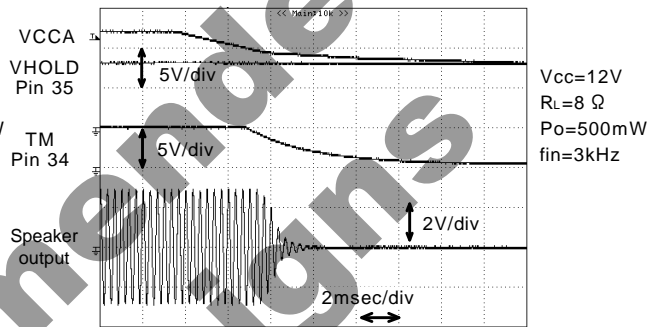

Fig. 16 Wave form on Instantaneous Power Interruption(2msec / div)

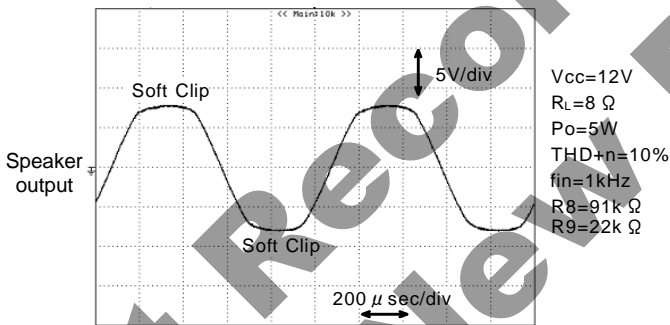

Fig. 17 Wave form on Output Power Limiter function (Po = 5W)

●Electrical characteristic curves (Reference data) – Continued

(2) Under Stereo Operation($R_L=6\Omega$)

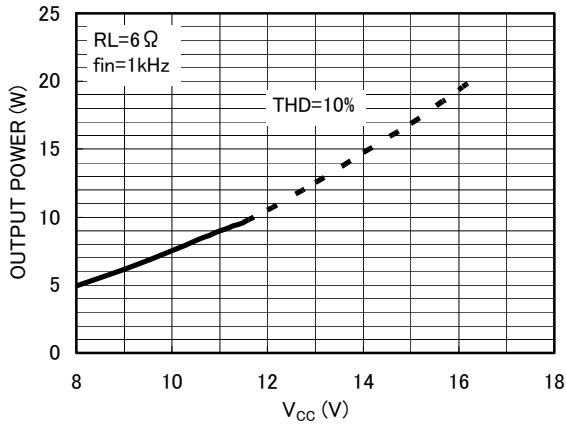

Fig. 18 Output power - Power supply voltage

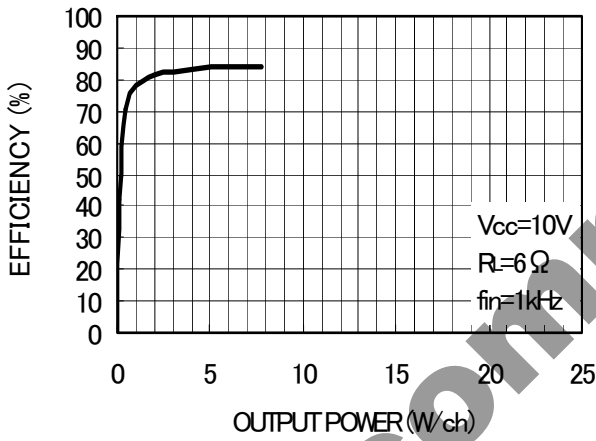

Fig. 19 Efficiency - Output power

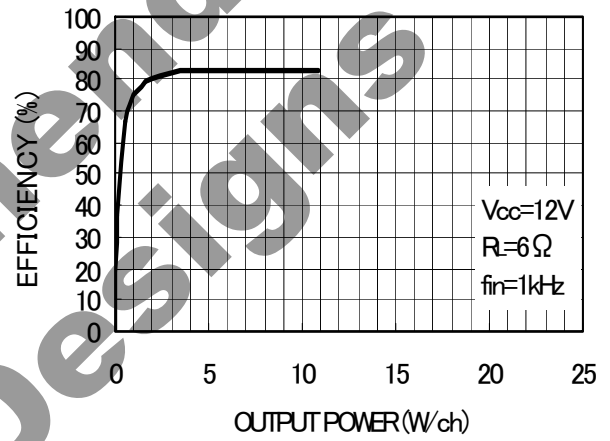

Fig. 20 Efficiency - Output power

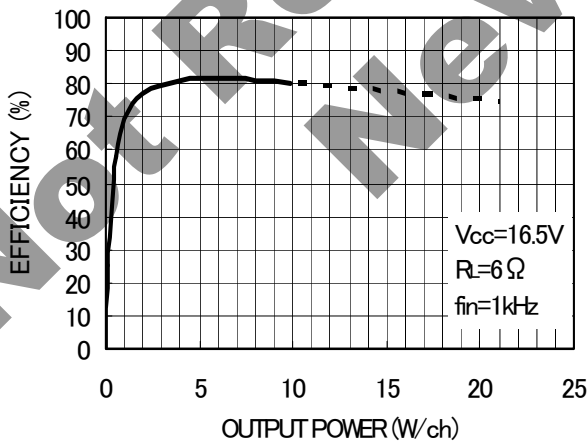

Fig. 21 Efficiency - Output power

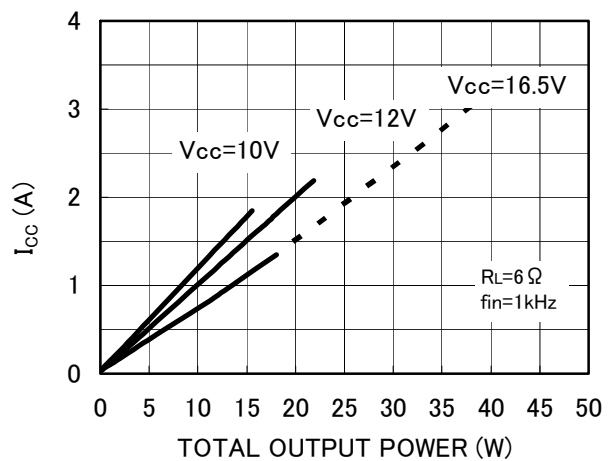

Fig. 22 Current consumption - Output power

Dotted lines of the graphs indicate continuous output power to be obtained on musical signal source or by installing additional heat sinks.

●Block diagram

Top View

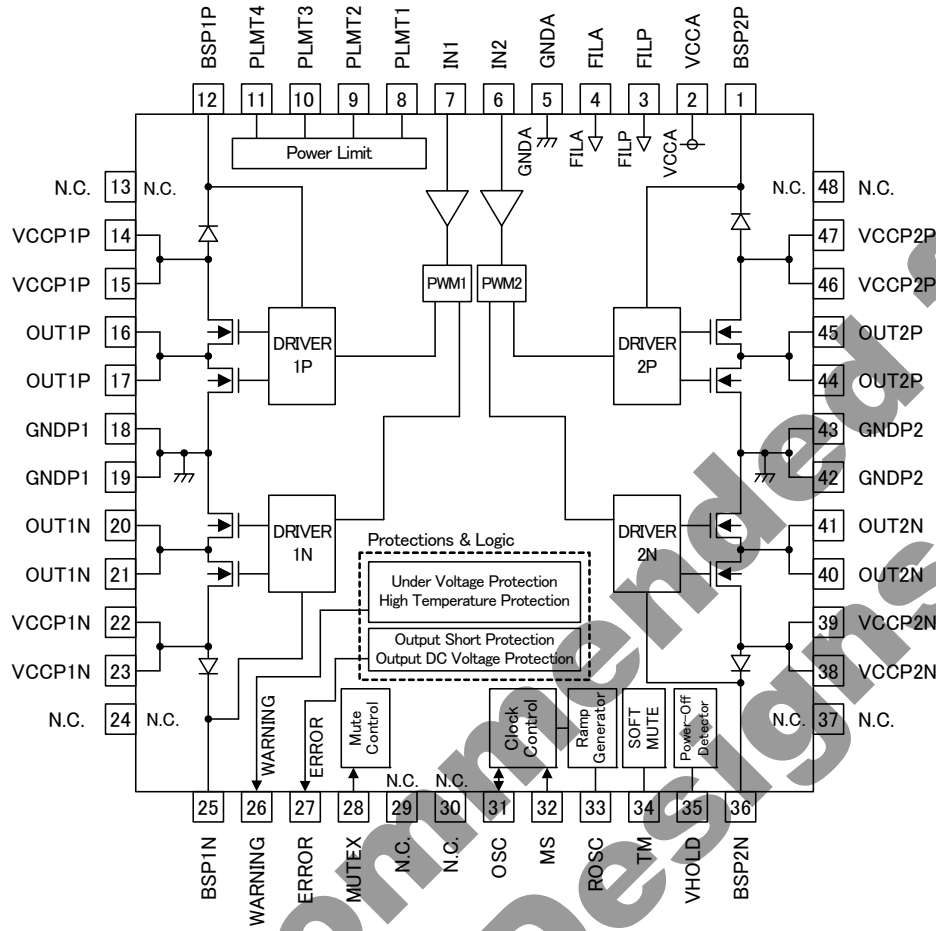

Fig. 23 Pin Assignment Diagram

●Outer Dimensions and Inscriptions

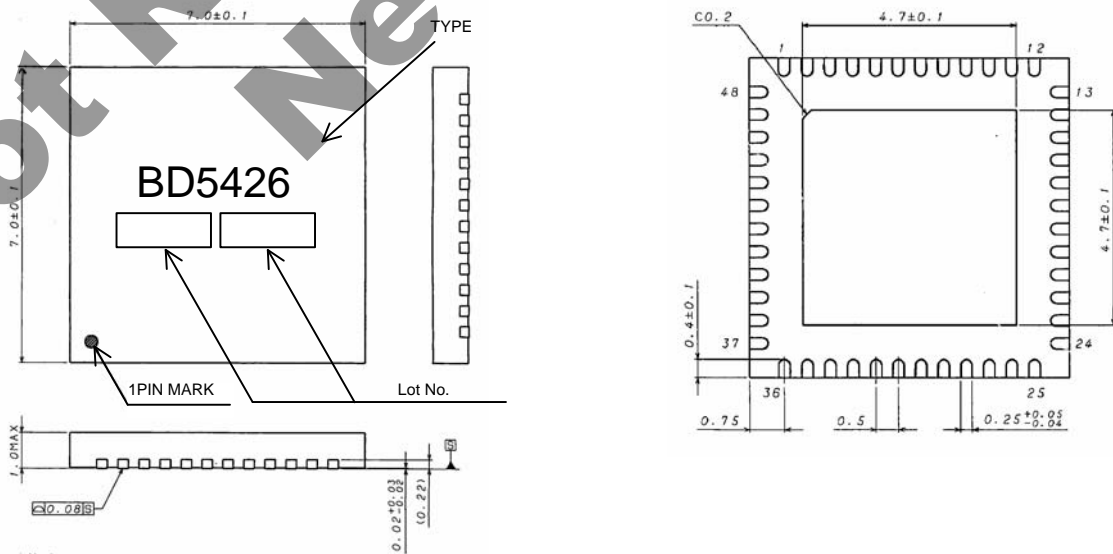
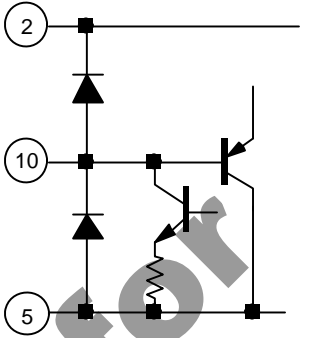
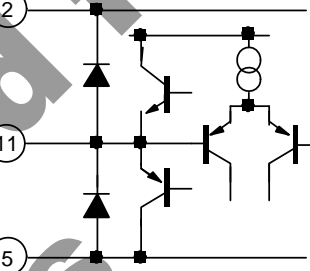
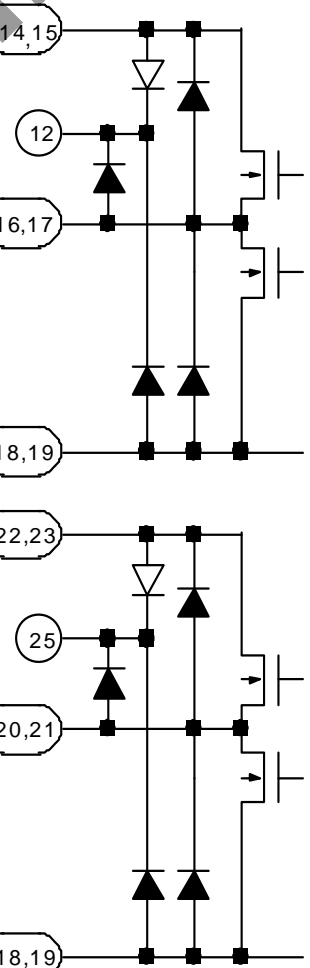

Fig. 24 Outer Dimensions and Inscriptions of VQFN048V7070 Package

●Explanation of Pin Functions (Provided pin voltages are typical values.)

No.	Symbol	Pin voltage	Pin description	Internal equalizing circuit
2	VCCA	Vcc	Analog system power pin	
3	FILP	Vcc+35 12	PWM system bias pin Connect a capacitor.	
4	FILA	3.5V	Analog signal system bias pin Connect a capacitor.	
5	GNDA	0V	Analog system GND pin	
6 7	IN2 IN1	3.5V	ch2 Analog signal input pin ch1 Analog signal input pin Input audio signal via a capacitor.	
8	PLMT1	3.5V	Voltage-to-current conversion pin for output power limiter function Connect a register.	
9	PLMT2	-	Current-to-voltage conversion pin for output power limiter function Connect a register.	

●Explanation of Pin Functions - Continued

No.	Symbol	Pin voltage	Pin description	Internal equalizing circuit
10	PLMT3	-	Current-to-voltage conversion pin for output power limiter function Connect a register.	
11	PLMT4	3.5V	Bias pin for output power limiter function Connect a register and a capacitor.	
12	BSP1P	-	ch1 positive bootstrap pin Connect a capacitor.	
14, 15	VCCP1P	Vcc	ch1 positive power system power supply pin	
16, 17	OUT1P	Vcc ~ 0V	ch1 positive PWM signal output pin Connect with output LPF.	
18, 19	GNDP1	0V	ch1 power system GND pin	
20, 21	OUT1N	Vcc ~ 0V	ch1 negative PWM signal output pin Connect with output LPF.	
22, 23	VCCP1N	Vcc	ch1 negative power system power supply pin	
25	BSP1N	-	ch1 negative bootstrap pin Connect a capacitor	

●Explanation of Pin Functions - Continued

No.	Symbol	Pin voltage	Pin description	Internal equalizing circuit
26	WARNING	H: 5V L: 0V	Warning output pin Pin to notify operation warning. H: Under warning L: Normal operation Connect a resistor.	
27	ERROR	H: 5V L: 0V	Error output pin A pin for notifying operation errors. H: Error L: Normal operation Connect a resistor.	
28	MUTEX	-	Audio mute control pin H: Mute off L: Mute on	
13, 24 29, 30 37, 48	N.C.	-	N.C. pin Nothing is connected with IC internal circuit.	
31	OSC	-	Sampling clock signal input/output pin When using two or more sampling clocks, connect via a capacitor.	
32	MS	-	Master/Slave switching pin Switching of master/slave functions on a sampling clock signal. H: Slave operation L: Master operation	

●Explanation of Pin Functions - Continued

No.	Symbol	Pin voltage	Pin description	Internal equalizing circuit
33	ROSC	5.6V	Internal PWM sampling clock frequency setting pin Usually the pin is used open. To adjust an internal sampling clock frequency, connect a resistor.	
34	TM	0 ~ 5V	Audio muting constant setting pin Connect a capacitor.	
35	VHOLD	0.68xVcc	Instantaneous power interruption detecting voltage setting pin Connect a capacitor. To adjust a detecting voltage, connect a resistor.	
36	BSP2N	-	ch2 negative bootstrap pin Connect a capacitor.	
38, 39	VCCP2N	Vcc	ch2 negative power system power supply pin	
40, 41	OUT2N	Vcc ~ 0V	ch2 negative PWM signal output pin Connect an output LPF.	
42, 43	GNDP2	0V	cch2 power system GND pin	
44, 45	OUT2P	Vcc ~ 0V	ch2 positive PWM signal output pin Connect an output LPF.	
46, 47	VCCP2P	Vcc	ch2 positive power system power supply pin	
1	BSP2P	-	ch2 positive bootstrap pin Connect a capacitor.	

● Application Circuit Diagram

• Vcc=10V ~ 16.5V

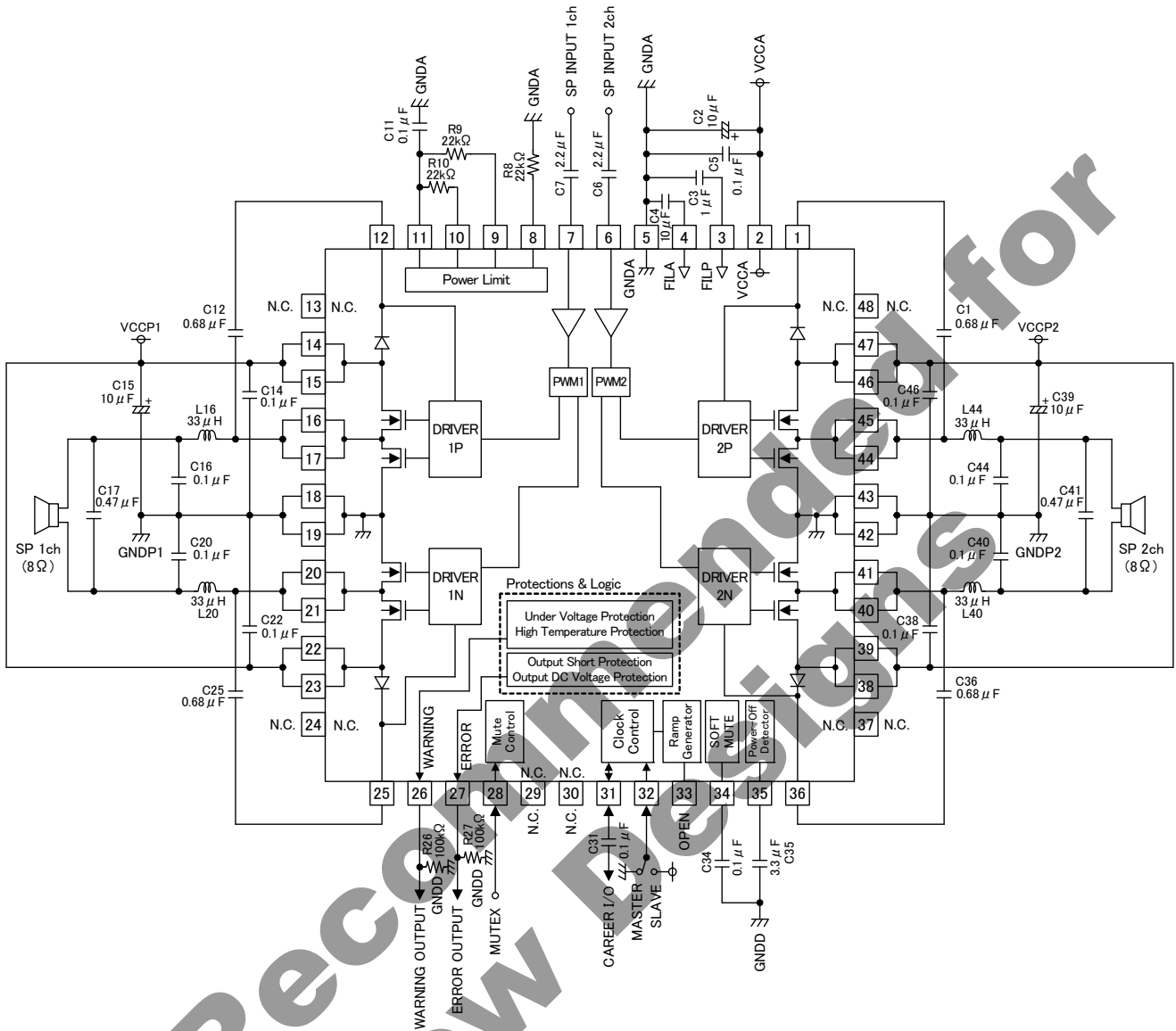

Fig. 25 Circuit Diagram of Stereo Operation with 8Ω Load

Table 1 BOM List of Stereo Operation with 8Ω Load

No.	Item	Part Number	Vendor	Configuration		Value	Rated voltage	Tolerance	Temperature characteristics	Quantity	Reference
				mm	inch						
1	IC	BD5426MUV	ROHM	VQFN048V7070		-	-	-	-	1	IC1
2	C	GRM219B31E684KA88	MURATA	2012	0805	0.68μF	25V	±10%	±10%	4	C1, C12, C25, C36
3	C	GRM188R11H104KA93	MURATA	1608	0603	0.1μF	50V	±10%	±15%	5	C5, C14, C22, C38, C46
4	C	GRM21BB11H104KA01	MURATA	2012	0805	0.1μF	50V	±10%	±10%	4	C16, C20, C40, C44
5	C	25ST225M3216	Rubycon	3225	1210	2.2μF	25V	±20%	±5%	2	C6, C7
6	C	50ST474M3225	Rubycon	3225	1210	0.47μF	50V	±20%	±5%	2	C17, C41
7	C	GRM21BB31E335KA75	MURATA	2012	0805	3.3μF	25V	±10%	±10%	1	C35
8	C	GRM188B11E104KA01	MURATA	1608	0603	0.1μF	25V	±10%	±10%	3	C11, C31, C34
9	C	GRM21BB11C105KA01	MURATA	2012	0805	1μF	16V	±10%	±10%	1	C3
10	C	GRM21BB31C106KE15	MURATA	2012	0805	10μF	16V	±10%	±10%	1	C4
11	C	25SVPD10M	SANYO	6666	2626	10μF	25V	±20%	±25%	3	C2, C15, C39
12	R	MCR01MZPF2202	ROHM	1005	0402	22kΩ	50V	±1%	±200ppm/°C	3	R8, R9, R10
13	R	MCR01MZPF1003	ROHM	1005	0402	100kΩ	50V	±1%	±200ppm/°C	2	R26, R27

No.	Item	Part Number	Vendor	Configuration		Value	Tolerance	DC Resistance	Rated DC Current	Quantity	Reference
				mm							
14	L	7G09B-330M	SAGAMI	10×9×10		33μH×2	±20%	44mΩmax.	4.1A max.	2	L16, L20, L40, L44

●Notes for use

1. About absolute maximum ratings

If an applied voltage or an operating temperature exceeds an absolute maximum rating, it may cause destruction of a device. A result of destruction, whether it is short mode or open mode, is not predictable. Therefore, provide a physical safety measure such as fuse, against a special mode that may violate conditions of absolute maximum ratings.

2. About power supply line

As return of current regenerated by back EMF of output coil happens, take steps such as putting capacitor between power supply and GND as a electric pathway for the regenerated current. Be sure that there is no problem with each property such as emptied capacity at lower temperature regarding electrolytic capacitor to decide capacity value. If the connected power supply does not have sufficient current absorption capacity, regenerative current will cause the voltage on the power supply line to rise, which combined with the product and its peripheral circuitry may exceed the absolute maximum ratings. It is recommended to implement a physical safety measure such as the insertion of a voltage clamp diode between the power supply and GND pins.

3. Potential of GND (5, 18, 39, 42, and 43 pins)

Potential of the GND terminal must be the lowest under any operating conditions.

4. About thermal design

Perform thermal design with sufficient margins, in consideration of maximum power dissipation P_d under actual operating conditions. This product has an exposed frame on the back of the package, and it is assumed that the frame is used with measures to improve efficiency of heat dissipation. In addition to front surface of board, provide a heat dissipation pattern as widely as possible on the back also.

A class-D power amplifier has heat dissipation efficiency far higher than that of conventional analog power amplifier and generates less heat. However, extra attention must be paid in thermal design so that a power dissipation P_{diss} should not exceed the maximum power dissipation P_d .

Maximum power dissipation $P_d = \frac{T_{jmax} - T_a}{\theta_{ja}} \quad [W]$

T_{jmax} : Maximum temperature junction = 150[°C]

T_a : Operating ambient temperature [°C]

θ_{ja} : Package thermal resistance [°C/W]

Power dissipation $P_{diss} = P_o \left(\frac{1}{\eta} - 1 \right) \quad [W]$

P_o : Output power [W]

η : Efficiency

5. About operations in strong electric field

Note that the device may malfunction in a strong electric field.

6. Thermal shutdown (TSD) circuit

This product is provided with a built-in thermal shutdown circuit. When the thermal shutdown circuit operates, the output transistors are placed under open status. The thermal shutdown circuit is primarily intended to shut down the IC avoiding thermal runaway under abnormal conditions with a chip temperature exceeding $T_{jmax} = 150^\circ\text{C}$, and is not intended to protect and secure an electrical appliance. Accordingly, do not use this circuit function to protect a customer's electrical appliance.

7. About shorting between pins and installation failure

Be careful about direction and displacement of an IC when installing it onto the board. Faulty installation may destroy the IC when the device is energized. In addition, a foreign matter getting in between IC pins, pins and power supply, and pins and GND may cause shorting and destruction of the IC.

8. About power supply startup and shutdown

When starting up a power supply, be sure to place the MUTEX pin (pin 28) at "L" level. When shutting down a power supply also, be sure to place the pin at "L" level. Those processes reduce pop noises generated upon turning on and off the power supply. In addition, all power supply pins must be started up and shut down at the same time.

9. About WARNING output pin (pin 26) and ERROR output pin (pin 27)

A WARNING flag is output from the WARNING output pin upon operation of the high-temperature protection function and under-voltage protection function. And an ERROR flag is output from the ERROR output pin upon operation of VCC/GND shorting protection function and speaker DC voltage applying protection function. These flags are the function which the condition of this product is shown in. The use which aimed at the protection except for this product is prohibition.

10. About N.C. pins (pins 13, 24, 29, 30, 37, and 48)

The N.C. (Non connection) pins are not connected with an internal circuit. Leave the pins open or connect them to GND.

●Ordering part number

B	D
---	---

Part No

5	4	2	6
---	---	---	---

Part No.

M	U	V
---	---	---

Package
MUV: VQFN048V7070

E	2
---	---

Packaging and forming specification
E2: Embossed tape and reel

VQFN048V7070

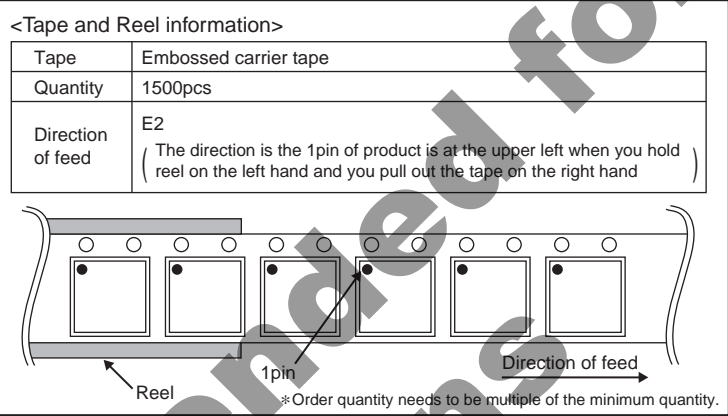
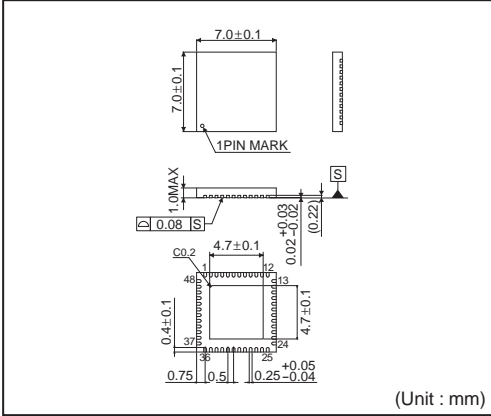

Not Recommended for New Design

Notice

Precaution on using ROHM Products

- Our Products are designed and manufactured for application in ordinary electronic equipments (such as AV equipment, OA equipment, telecommunication equipment, home electronic appliances, amusement equipment, etc.). If you intend to use our Products in devices requiring extremely high reliability (such as medical equipment ^(Note 1), transport equipment, traffic equipment, aircraft/spacecraft, nuclear power controllers, fuel controllers, car equipment including car accessories, safety devices, etc.) and whose malfunction or failure may cause loss of human life, bodily injury or serious damage to property ("Specific Applications"), please consult with the ROHM sales representative in advance. Unless otherwise agreed in writing by ROHM in advance, ROHM shall not be in any way responsible or liable for any damages, expenses or losses incurred by you or third parties arising from the use of any ROHM's Products for Specific Applications.

(Note1) Medical Equipment Classification of the Specific Applications

JAPAN	USA	EU	CHINA
CLASS III	CLASS III	CLASS II b	CLASS III
CLASS IV		CLASS III	

- ROHM designs and manufactures its Products subject to strict quality control system. However, semiconductor products can fail or malfunction at a certain rate. Please be sure to implement, at your own responsibilities, adequate safety measures including but not limited to fail-safe design against the physical injury, damage to any property, which a failure or malfunction of our Products may cause. The following are examples of safety measures:
 - Installation of protection circuits or other protective devices to improve system safety
 - Installation of redundant circuits to reduce the impact of single or multiple circuit failure
- Our Products are designed and manufactured for use under standard conditions and not under any special or extraordinary environments or conditions, as exemplified below. Accordingly, ROHM shall not be in any way responsible or liable for any damages, expenses or losses arising from the use of any ROHM's Products under any special or extraordinary environments or conditions. If you intend to use our Products under any special or extraordinary environments or conditions (as exemplified below), your independent verification and confirmation of product performance, reliability, etc. prior to use, must be necessary:
 - Use of our Products in any types of liquid, including water, oils, chemicals, and organic solvents
 - Use of our Products outdoors or in places where the Products are exposed to direct sunlight or dust
 - Use of our Products in places where the Products are exposed to sea wind or corrosive gases, including Cl₂, H₂S, NH₃, SO₂, and NO₂
 - Use of our Products in places where the Products are exposed to static electricity or electromagnetic waves
 - Use of our Products in proximity to heat-producing components, plastic cords, or other flammable items
 - Sealing or coating our Products with resin or other coating materials
 - Use of our Products without cleaning residue of flux (even if you use no-clean type fluxes, cleaning residue of flux is recommended); or Washing our Products by using water or water-soluble cleaning agents for cleaning residue after soldering
 - Use of the Products in places subject to dew condensation
- The Products are not subject to radiation-proof design.
- Please verify and confirm characteristics of the final or mounted products in using the Products.
- In particular, if a transient load (a large amount of load applied in a short period of time, such as pulse. is applied, confirmation of performance characteristics after on-board mounting is strongly recommended. Avoid applying power exceeding normal rated power; exceeding the power rating under steady-state loading condition may negatively affect product performance and reliability.
- De-rate Power Dissipation (Pd) depending on Ambient temperature (Ta). When used in sealed area, confirm the actual ambient temperature.
- Confirm that operation temperature is within the specified range described in the product specification.
- ROHM shall not be in any way responsible or liable for failure induced under deviant condition from what is defined in this document.

Precaution for Mounting / Circuit board design

- When a highly active halogenous (chlorine, bromine, etc.) flux is used, the residue of flux may negatively affect product performance and reliability.
- In principle, the reflow soldering method must be used; if flow soldering method is preferred, please consult with the ROHM representative in advance.

For details, please refer to ROHM Mounting specification

Precautions Regarding Application Examples and External Circuits

1. If change is made to the constant of an external circuit, please allow a sufficient margin considering variations of the characteristics of the Products and external components, including transient characteristics, as well as static characteristics.
2. You agree that application notes, reference designs, and associated data and information contained in this document are presented only as guidance for Products use. Therefore, in case you use such information, you are solely responsible for it and you must exercise your own independent verification and judgment in the use of such information contained in this document. ROHM shall not be in any way responsible or liable for any damages, expenses or losses incurred by you or third parties arising from the use of such information.

Precaution for Electrostatic

This Product is electrostatic sensitive product, which may be damaged due to electrostatic discharge. Please take proper caution in your manufacturing process and storage so that voltage exceeding the Products maximum rating will not be applied to Products. Please take special care under dry condition (e.g. Grounding of human body / equipment / solder iron, isolation from charged objects, setting of ionizer, friction prevention and temperature / humidity control).

Precaution for Storage / Transportation

1. Product performance and soldered connections may deteriorate if the Products are stored in the places where:
 - [a] the Products are exposed to sea winds or corrosive gases, including Cl₂, H₂S, NH₃, SO₂, and NO₂
 - [b] the temperature or humidity exceeds those recommended by ROHM
 - [c] the Products are exposed to direct sunshine or condensation
 - [d] the Products are exposed to high Electrostatic
2. Even under ROHM recommended storage condition, solderability of products out of recommended storage time period may be degraded. It is strongly recommended to confirm solderability before using Products of which storage time is exceeding the recommended storage time period.
3. Store / transport cartons in the correct direction, which is indicated on a carton with a symbol. Otherwise bent leads may occur due to excessive stress applied when dropping of a carton.
4. Use Products within the specified time after opening a humidity barrier bag. Baking is required before using Products of which storage time is exceeding the recommended storage time period.

Precaution for Product Label

QR code printed on ROHM Products label is for ROHM's internal use only.

Precaution for Disposition

When disposing Products please dispose them properly using an authorized industry waste company.

Precaution for Foreign Exchange and Foreign Trade act

Since our Products might fall under controlled goods prescribed by the applicable foreign exchange and foreign trade act, please consult with ROHM representative in case of export.

Precaution Regarding Intellectual Property Rights

1. All information and data including but not limited to application example contained in this document is for reference only. ROHM does not warrant that foregoing information or data will not infringe any intellectual property rights or any other rights of any third party regarding such information or data. ROHM shall not be in any way responsible or liable for infringement of any intellectual property rights or other damages arising from use of such information or data.:
2. No license, expressly or implied, is granted hereby under any intellectual property rights or other rights of ROHM or any third parties with respect to the information contained in this document.

Other Precaution

1. This document may not be reprinted or reproduced, in whole or in part, without prior written consent of ROHM.
2. The Products may not be disassembled, converted, modified, reproduced or otherwise changed without prior written consent of ROHM.
3. In no event shall you use in any way whatsoever the Products and the related technical information contained in the Products or this document for any military purposes, including but not limited to, the development of mass-destruction weapons.
4. The proper names of companies or products described in this document are trademarks or registered trademarks of ROHM, its affiliated companies or third parties.

General Precaution

1. Before you use our Products, you are requested to carefully read this document and fully understand its contents. ROHM shall not be in any way responsible or liable for failure, malfunction or accident arising from the use of any ROHM's Products against warning, caution or note contained in this document.
2. All information contained in this document is current as of the issuing date and subject to change without any prior notice. Before purchasing or using ROHM's Products, please confirm the latest information with a ROHM sales representative.
3. The information contained in this document is provided on an "as is" basis and ROHM does not warrant that all information contained in this document is accurate and/or error-free. ROHM shall not be in any way responsible or liable for any damages, expenses or losses incurred by you or third parties resulting from inaccuracy or errors of or concerning such information.

**Not Recommended for
New Designs**