



STW25N95K3

N-channel 950 V, 0.32 Ω , 22 A, TO-247
SuperMESH3™ Power MOSFET

Features

Type	V _{DSS}	R _{DS(on) max}	I _D	P _w
STW25N95K3	950 V	< 0.36 Ω	22 A	400 W

- 100% avalanche tested
- Extremely large avalanche performance
- Gate charge minimized
- Very low intrinsic capacitances
- Zener-protected

Application

- Switching applications

Description

This SuperMESH3™ Power MOSFET is the result of improvements applied to STMicroelectronics' SuperMESH™ technology, combined with a new optimized vertical structure. This device boasts an extremely low on-resistance, superior dynamic performance and high avalanche capability, rendering it suitable for the most demanding applications.

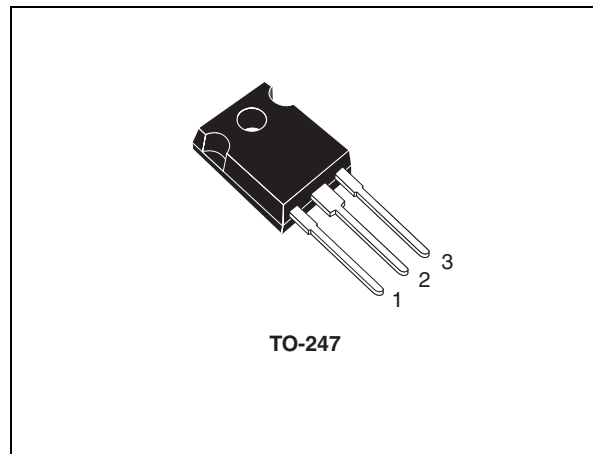

Figure 1. Internal schematic diagram

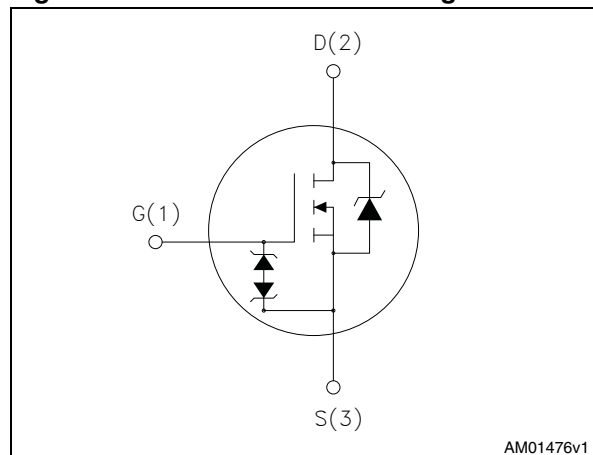

Table 1. Device summary

Order code	Marking	Package	Packaging
STW25N95K3	25N95K3	TO-247	Tube

Contents

1	Electrical ratings	3
2	Electrical characteristics	4
	2.1 Electrical characteristics (curves)	6
3	Test circuits	9
4	Package mechanical data	10
5	Revision history	12

1 Electrical ratings

Table 2. Absolute maximum ratings

Symbol	Parameter	Value	Unit
V_{GS}	Gate- source voltage	± 30	V
I_D	Drain current (continuous) at $T_C = 25\text{ }^\circ\text{C}$	22	A
I_D	Drain current (continuous) at $T_C = 100\text{ }^\circ\text{C}$	13.9	A
$I_{DM}^{(1)}$	Drain current (pulsed)	88	A
P_{TOT}	Total dissipation at $T_C = 25\text{ }^\circ\text{C}$	400	W
I_{AR}	Avalanche current, repetitive or not-repetitive (pulse width limited by T_J max)	28	A
E_{AS}	Single pulse avalanche energy (starting $T_J = 25\text{ }^\circ\text{C}$, $I_D = I_{AR}$, $V_{DD} = 50\text{ V}$)	450	mJ
$dv/dt^{(2)}$	Peak diode recovery voltage slope	5	V/ns
$V_{ESD(G-S)}$	G-S ESD (HBM $C=100\text{ pF}$; $R=1.5\text{ k}\Omega$)	6000	V
T_J T_{stg}	Operating junction temperature Storage temperature	-55 to 150	$^\circ\text{C}$

1. Pulse width limited by safe operating area.

2. $I_{SD} \leq 22\text{ A}$, $di/dt \leq 100\text{ A}/\mu\text{s}$, peak $V_{DS} \leq V_{(BR)DSS}$

Table 3. Thermal data

Symbol	Parameter	Value	Unit
$R_{thj-case}$	Thermal resistance junction-case max	0.31	$^\circ\text{C}/\text{W}$
$R_{thj-amb}$	Thermal resistance junction-ambient max	50	$^\circ\text{C}/\text{W}$
T_J	Maximum lead temperature for soldering purpose	300	$^\circ\text{C}/\text{W}$

2 Electrical characteristics

($T_{\text{case}} = 25^{\circ}\text{C}$ unless otherwise specified).

Table 4. On /off states

Symbol	Parameter	Test conditions	Min.	Typ.	Max.	Unit
$V_{(\text{BR})\text{DSS}}$	Drain-source breakdown voltage	$I_{\text{D}} = 1 \text{ mA}, V_{\text{GS}} = 0$	950			V
I_{DSS}	Zero gate voltage drain current ($V_{\text{GS}} = 0$)	$V_{\text{DS}} = \text{Max rating}$ $V_{\text{DS}} = \text{Max rating}, T_{\text{C}} = 125^{\circ}\text{C}$			1 50	μA μA
I_{GSS}	Gate-body leakage current ($V_{\text{DS}} = 0$)	$V_{\text{GS}} = \pm 20 \text{ V}$			10	μA
$V_{\text{GS}(\text{th})}$	Gate threshold voltage	$V_{\text{DS}} = V_{\text{GS}}, I_{\text{D}} = 150 \mu\text{A}$	3	4	5	V
$R_{\text{DS}(\text{on})}$	Static drain-source on resistance	$V_{\text{GS}} = 10 \text{ V}, I_{\text{D}} = 11 \text{ A}$		0.32	0.36	Ω

Table 5. Dynamic

Symbol	Parameter	Test conditions	Min.	Typ.	Max.	Unit
$g_{\text{fs}}^{(1)}$	Forward transconductance	$V_{\text{DS}} = 15 \text{ V}, I_{\text{D}} = 11 \text{ A}$	-	22	-	S
C_{iss} C_{oss} C_{rss}	Input capacitance Output capacitance Reverse transfer capacitance	$V_{\text{DS}} = 100 \text{ V}, f = 1 \text{ MHz},$ $V_{\text{GS}} = 0$	-	3680 246 2	-	pF pF pF
$C_{\text{o}(\text{tr})}^{(2)}$	Equivalent capacitance time related	$V_{\text{DS}} = 0 \text{ to } 760 \text{ V}, V_{\text{GS}} = 0$	-	198	-	pF
$C_{\text{o}(\text{er})}^{(3)}$	Equivalent capacitance energy related	$V_{\text{DS}} = 0 \text{ to } 760 \text{ V}, V_{\text{GS}} = 0$	-	278	-	pF
R_{g}	Gate input resistance	$f = 1 \text{ MHz}$ open drain	-	3	-	Ω
Q_{g} Q_{gs} Q_{gd}	Total gate charge Gate-source charge Gate-drain charge	$V_{\text{DD}} = 760 \text{ V}, I_{\text{D}} = 22 \text{ A},$ $V_{\text{GS}} = 10 \text{ V}$ (see Figure 16)	-	105 23 57	-	nC nC nC

1. Pulsed: Pulse duration = 300 μs , duty cycle 1.5%
2. $C_{\text{oss eq}}$ time related is defined as a constant equivalent capacitance giving the same charging time as C_{oss} when V_{DS} increases from 0 to 80% V_{DSS}
3. $C_{\text{oss eq}}$ energy related is defined as a constant equivalent capacitance giving the same stored energy as C_{oss} when V_{DS} increases from 0 to 80% V_{DSS}

Table 6. Switching times

Symbol	Parameter	Test conditions	Min.	Typ.	Max	Unit
$t_{d(on)}$	Turn-on delay time	$V_{DD} = 475 \text{ V}$, $I_D = 11 \text{ A}$, $R_G = 4.7 \Omega$, $V_{GS} = 10 \text{ V}$ (see Figure 15)	-	39	-	ns
t_r	Rise time			29		ns
$t_{d(off)}$	Turn-off-delay time			97		ns
t_f	Fall time			59		ns

Table 7. Source drain diode

Symbol	Parameter	Test conditions	Min.	Typ.	Max	Unit
I_{SD}	Source-drain current		-		22	A
$I_{SDM}^{(1)}$	Source-drain current (pulsed)				88	A
$V_{SD}^{(2)}$	Forward on voltage	$I_{SD} = 22 \text{ A}$, $V_{GS} = 0$	-		1.6	V
t_{rr}	Reverse recovery time	$I_{SD} = 22 \text{ A}$, $di/dt = 100 \text{ A}/\mu\text{s}$ $V_{DD} = 60 \text{ V}$, $T_J = 25 \text{ }^\circ\text{C}$ (see Figure 17)	-	671		ns
Q_{rr}	Reverse recovery charge			17	μC	
I_{RRM}	Reverse recovery current			50	A	
t_{rr}	Reverse recovery time	$I_{SD} = 22 \text{ A}$, $di/dt = 100 \text{ A}/\mu\text{s}$ $V_{DD} = 60 \text{ V}$, $T_J = 150 \text{ }^\circ\text{C}$ (see Figure 17)	-	803		ns
Q_{rr}	Reverse recovery charge			21	μC	
I_{RRM}	Reverse recovery current			52	A	

1. Pulse width limited by safe operating area.

2. Pulsed: pulse duration = 300 μs , duty cycle 1.5%

Table 8. Gate-source Zener diode

Symbol	Parameter	Test conditions	Min.	Typ.	Max.	Unit
BV_{GSO}	Gate-source breakdown voltage	$I_{gs} = \pm 1 \text{ mA}$ (open drain)	30	-	-	V

The built-in back-to-back Zener diodes have specifically been designed to enhance not only the device's ESD capability, but also to make them safely absorb possible voltage transients that may occasionally be applied from gate to source. In this respect the Zener voltage is appropriate to achieve an efficient and cost-effective intervention to protect the device's integrity. These integrated Zener diodes thus avoid the usage of external components.

2.1 Electrical characteristics (curves)

Figure 2. Safe operating area

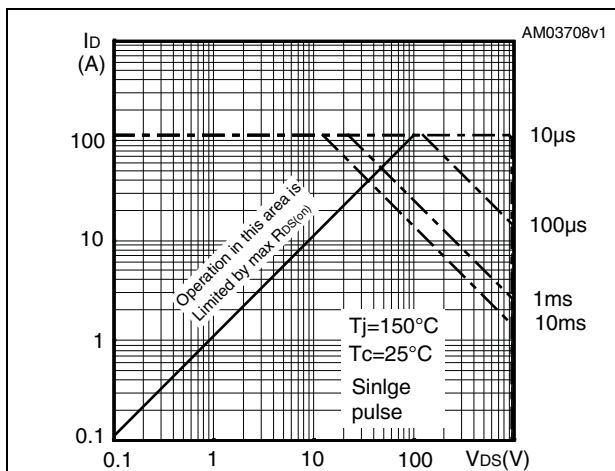

Figure 3. Thermal impedance

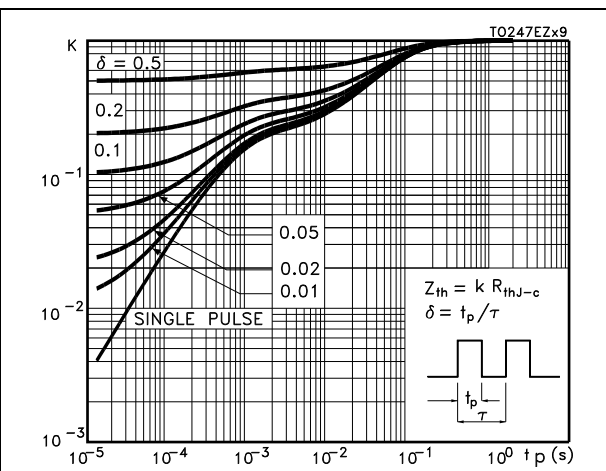

Figure 4. Output characteristics

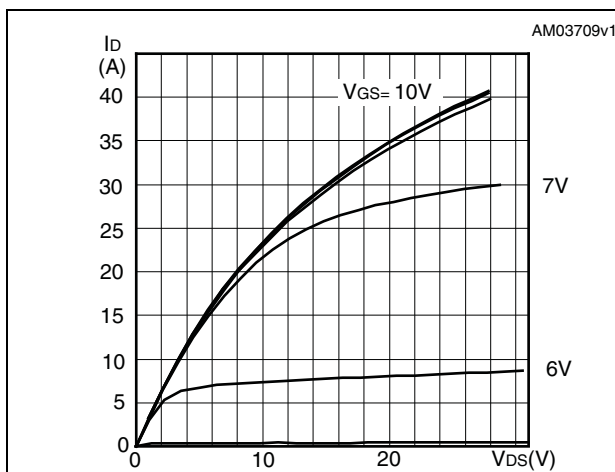

Figure 5. Transfer characteristics

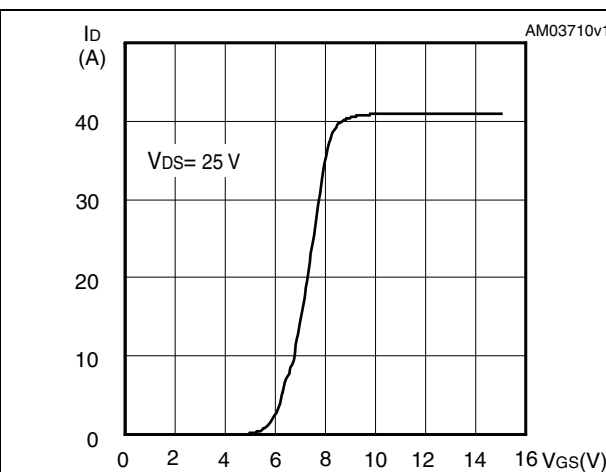

Figure 6. Normalized BV_{DSS} vs temperature

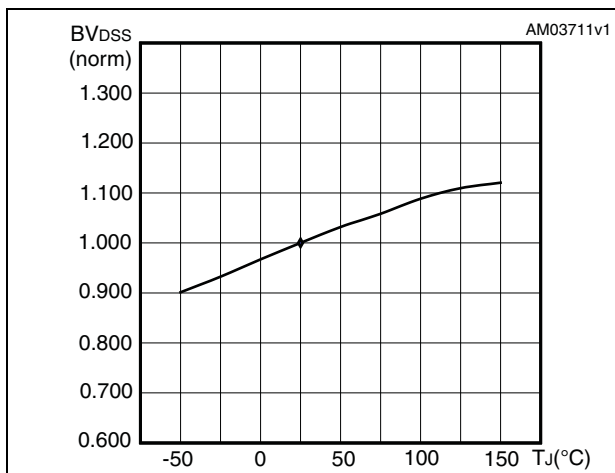

Figure 7. Static drain-source on resistance

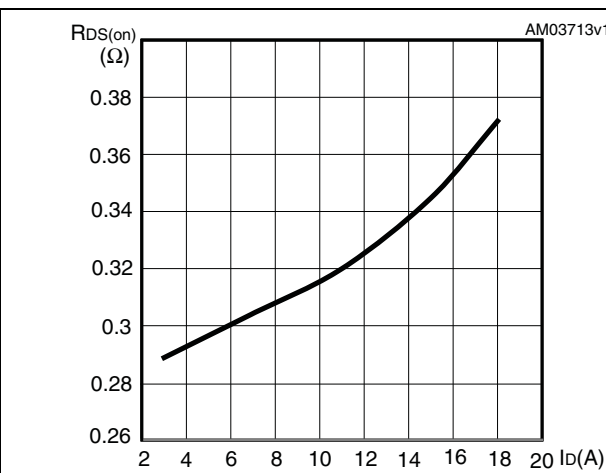

Figure 8. Output capacitance stored energy Figure 9. Capacitance variations

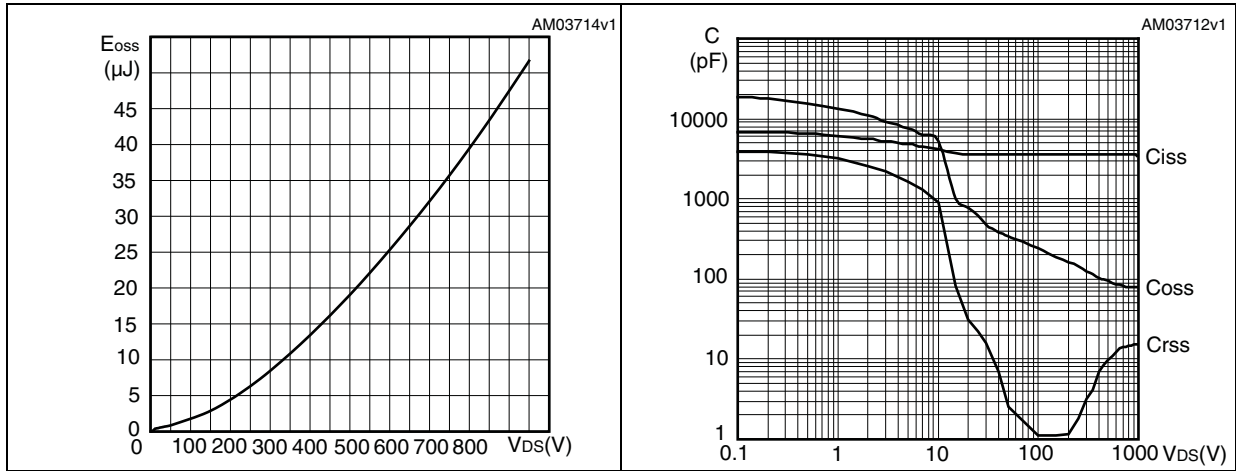

Figure 10. Gate charge vs gate-source voltage Figure 11. Normalized on resistance vs temperature

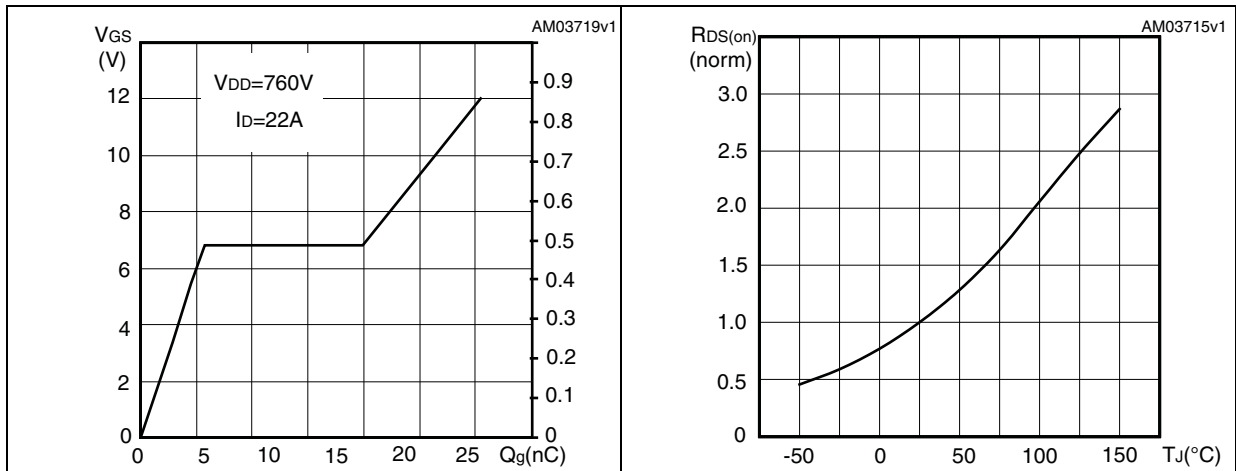

Figure 12. Normalized gate threshold voltage vs temperature Figure 13. Maximum avalanche energy vs temperature

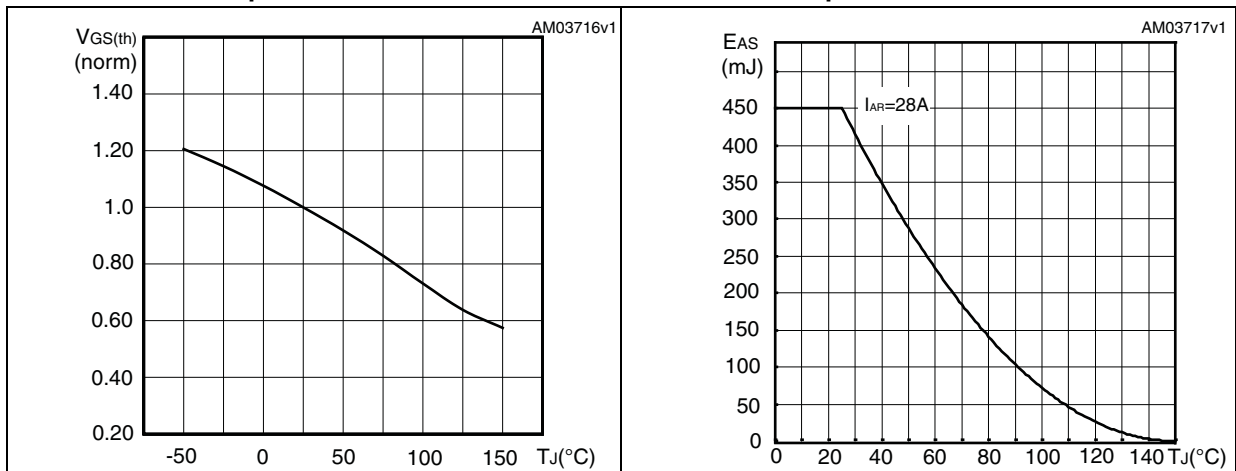
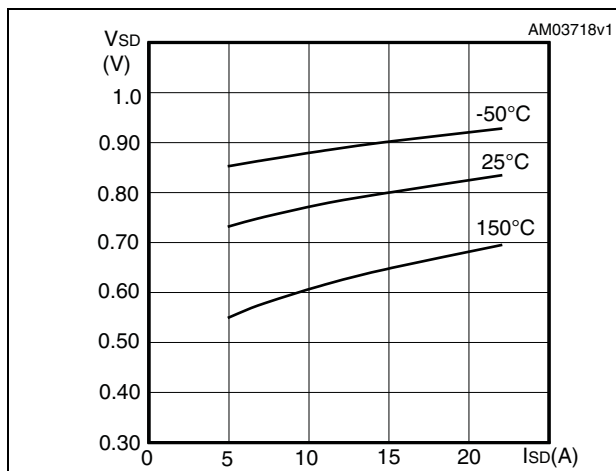

Figure 14. Source-drain diode forward characteristics



3 Test circuits

Figure 15. Switching times test circuit for resistive load



Figure 16. Gate charge test circuit



Figure 17. Test circuit for inductive load switching and diode recovery times

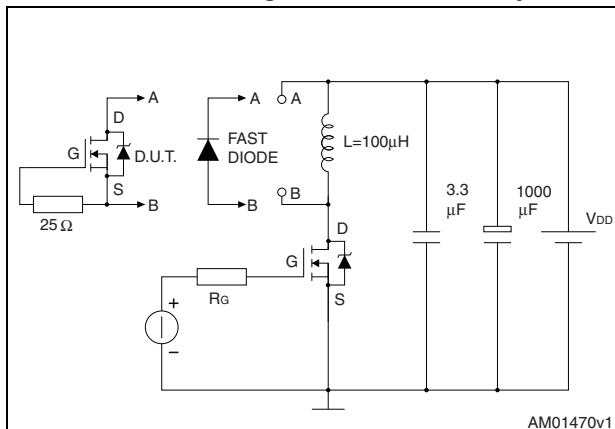

Figure 18. Unclamped inductive load test circuit



Figure 19. Unclamped inductive waveform

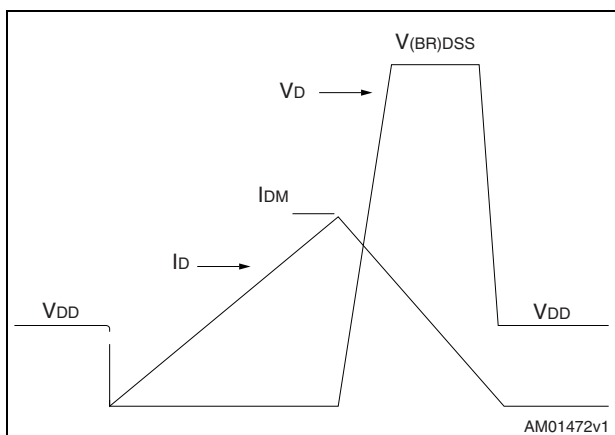
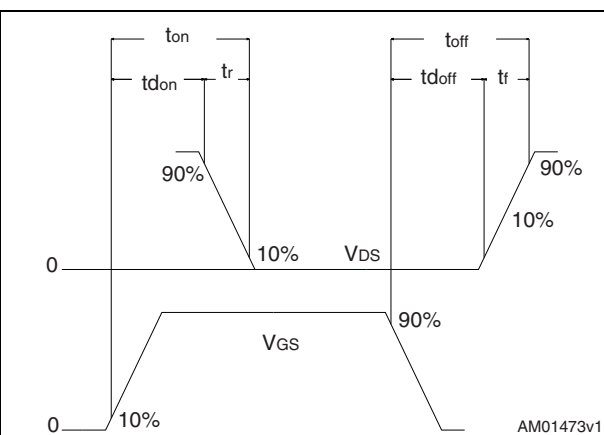

Figure 20. Switching time waveform



4 Package mechanical data

In order to meet environmental requirements, ST offers these devices in different grades of ECOPACK® packages, depending on their level of environmental compliance. ECOPACK® specifications, grade definitions and product status are available at: www.st.com. ECOPACK is an ST trademark.

Table 9. TO-247 mechanical data

Dim.	mm.		
	Min.	Typ.	Max.
A	4.85		5.15
A1	2.20		2.60
b	1.0		1.40
b1	2.0		2.40
b2	3.0		3.40
c	0.40		0.80
D	19.85		20.15
E	15.45		15.75
e	5.30	5.45	5.60
L	14.20		14.80
L1	3.70		4.30
L2		18.50	
ØP	3.55		3.65
ØR	4.50		5.50
S	5.30	5.50	5.70

Figure 21. TO-247 drawing

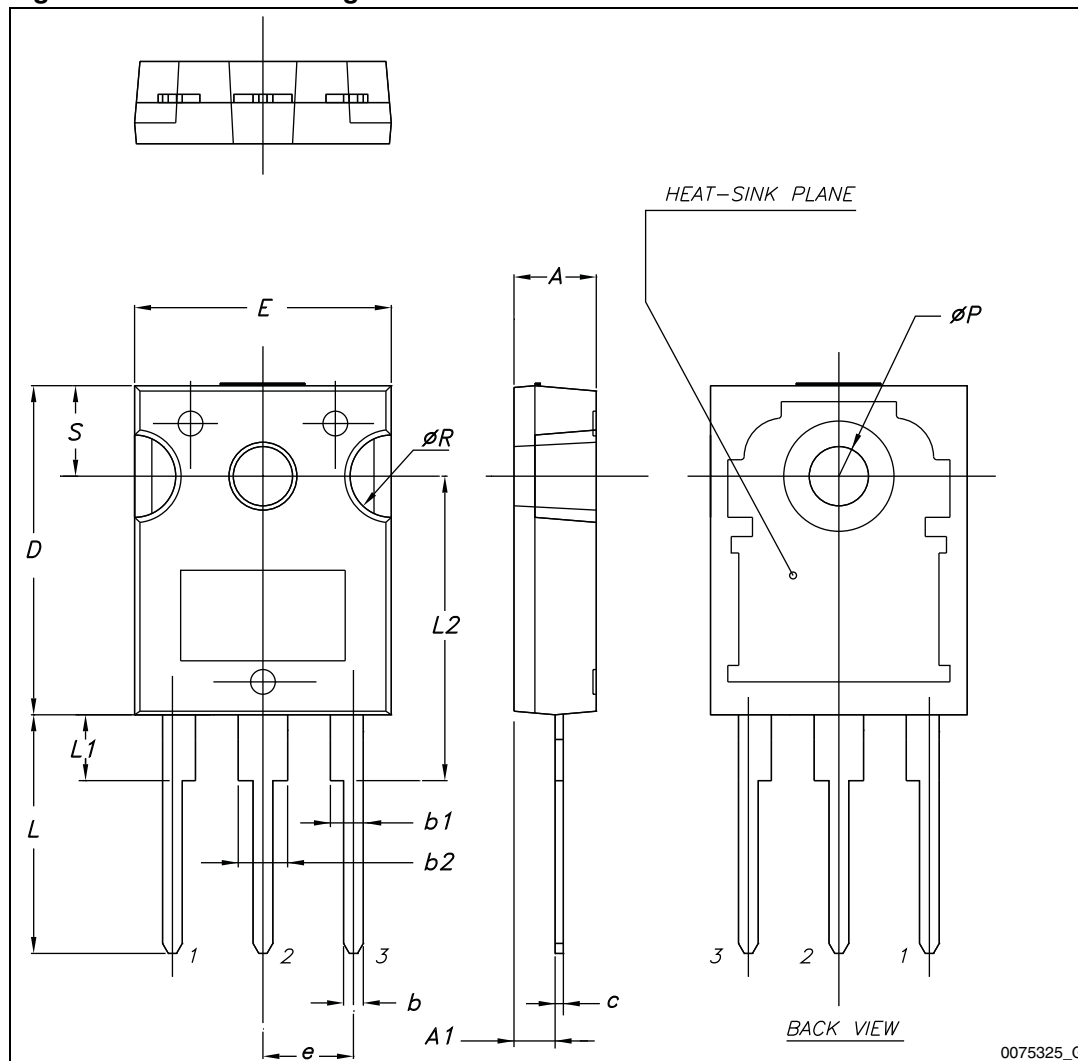

5 Revision history

Table 10. Document revision history

Date	Revision	Changes
27-Apr-2009	1	First release.
09-Jan-2012	2	Document status promoted from preliminary data to datasheet. Updated Section 4: Package mechanical data .

Please Read Carefully:

Information in this document is provided solely in connection with ST products. STMicroelectronics NV and its subsidiaries ("ST") reserve the right to make changes, corrections, modifications or improvements, to this document, and the products and services described herein at any time, without notice.

All ST products are sold pursuant to ST's terms and conditions of sale.

Purchasers are solely responsible for the choice, selection and use of the ST products and services described herein, and ST assumes no liability whatsoever relating to the choice, selection or use of the ST products and services described herein.

No license, express or implied, by estoppel or otherwise, to any intellectual property rights is granted under this document. If any part of this document refers to any third party products or services it shall not be deemed a license grant by ST for the use of such third party products or services, or any intellectual property contained therein or considered as a warranty covering the use in any manner whatsoever of such third party products or services or any intellectual property contained therein.

UNLESS OTHERWISE SET FORTH IN ST'S TERMS AND CONDITIONS OF SALE ST DISCLAIMS ANY EXPRESS OR IMPLIED WARRANTY WITH RESPECT TO THE USE AND/OR SALE OF ST PRODUCTS INCLUDING WITHOUT LIMITATION IMPLIED WARRANTIES OF MERCHANTABILITY, FITNESS FOR A PARTICULAR PURPOSE (AND THEIR EQUIVALENTS UNDER THE LAWS OF ANY JURISDICTION), OR INFRINGEMENT OF ANY PATENT, COPYRIGHT OR OTHER INTELLECTUAL PROPERTY RIGHT.

UNLESS EXPRESSLY APPROVED IN WRITING BY TWO AUTHORIZED ST REPRESENTATIVES, ST PRODUCTS ARE NOT RECOMMENDED, AUTHORIZED OR WARRANTED FOR USE IN MILITARY, AIR CRAFT, SPACE, LIFE SAVING, OR LIFE SUSTAINING APPLICATIONS, NOR IN PRODUCTS OR SYSTEMS WHERE FAILURE OR MALFUNCTION MAY RESULT IN PERSONAL INJURY, DEATH, OR SEVERE PROPERTY OR ENVIRONMENTAL DAMAGE. ST PRODUCTS WHICH ARE NOT SPECIFIED AS "AUTOMOTIVE GRADE" MAY ONLY BE USED IN AUTOMOTIVE APPLICATIONS AT USER'S OWN RISK.

Resale of ST products with provisions different from the statements and/or technical features set forth in this document shall immediately void any warranty granted by ST for the ST product or service described herein and shall not create or extend in any manner whatsoever, any liability of ST.

ST and the ST logo are trademarks or registered trademarks of ST in various countries.

Information in this document supersedes and replaces all information previously supplied.

The ST logo is a registered trademark of STMicroelectronics. All other names are the property of their respective owners.

© 2012 STMicroelectronics - All rights reserved

STMicroelectronics group of companies

Australia - Belgium - Brazil - Canada - China - Czech Republic - Finland - France - Germany - Hong Kong - India - Israel - Italy - Japan - Malaysia - Malta - Morocco - Philippines - Singapore - Spain - Sweden - Switzerland - United Kingdom - United States of America

www.st.com

