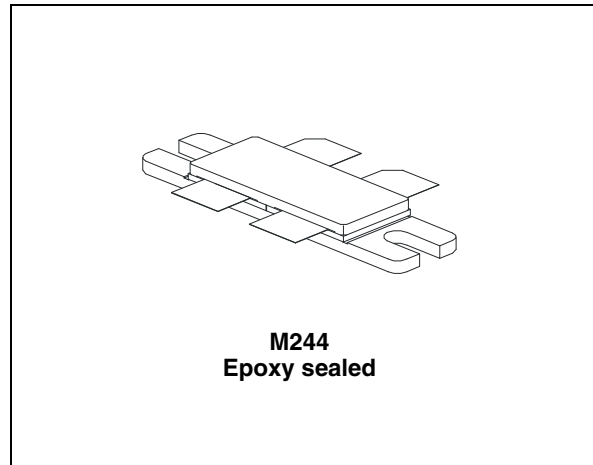
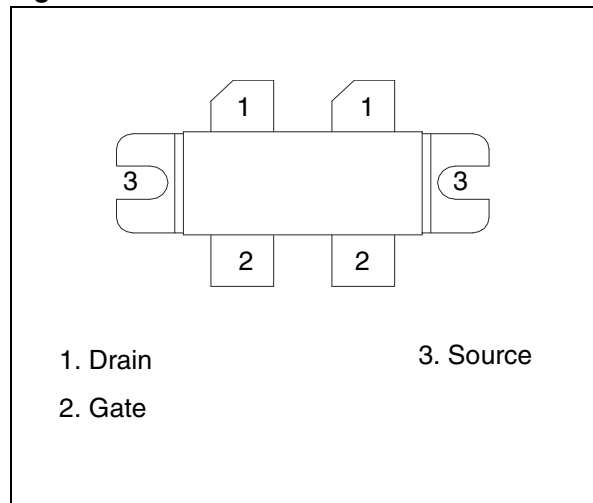

HF/VHF/UHF RF power N-channel MOSFETs
Features

- Gold metallization
- Excellent thermal stability
- Common source configuration, push-pull
- $P_{OUT} = 300 \text{ W min. with } 15 \text{ dB gain @ } 175 \text{ MHz}$

Description

The SD2932 is a gold metalized N-channel MOS field-effect RF power transistor, intended for use in 50 V dc large signal applications up to 250 MHz.

Figure 1. Pin connection

Table 1. Device summary

Order code	Marking	Base qty.	Package	Packaging
SD2932W	SD2932 ⁽¹⁾	15	M244	Tube

1. For more details please refer to [Chapter 12: Marking, packing and shipping specifications](#).

Contents

1	Electrical data	3
1.1	Maximum ratings	3
1.2	Thermal data	3
2	Electrical characteristics	4
2.1	Static	4
2.2	Dynamic	4
3	Impedance data	5
4	Typical performances	6
4.1	Typical performance (175 MHz)	8
5	Test circuit 175 MHz	10
6	Test circuit photomaster	12
7	Typical broadband data (175 - 230 MHz)	13
8	Test circuit 175 - 230 MHz	14
9	Typical broadband data (88 -108 MHz)	16
10	Test circuit 88 - 108 MHz	17
11	Package mechanical data	19
12	Marking, packing and shipping specifications	21
13	Revision history	22

1 Electrical data

1.1 Maximum ratings

Table 2. Absolute maximum ratings ($T_{CASE} = 25^{\circ}C$)

Symbol	Parameter	Value	Unit
$V_{(BR)DSS}$	Drain source voltage	125	V
V_{DGR}	Drain-gate voltage ($R_{GS} = 1M\Omega$)	125	V
V_{GS}	Gate-source voltage	± 20	V
I_D	Drain current	40	A
P_{DISS}	Power dissipation	500	W
T_j	Max. operating junction temperature	+200	$^{\circ}C$
T_{STG}	Storage temperature	-65 to +150	$^{\circ}C$

1.2 Thermal data

Table 3. Thermal data

Symbol	Parameter	Value	Unit
R_{thj-c}	Junction - case thermal resistance	0.35	$^{\circ}C/W$

2 Electrical characteristics

$$T_{CASE} = +25\text{ }^{\circ}\text{C}$$

2.1 Static

Table 4. Static (per section)

Symbol	Test conditions		Min	Typ	Max	Unit
$V_{(BR)DSS}$	$V_{GS} = 0\text{ V}$	$I_{DS} = 100\text{ mA}$	125			V
I_{DSS}	$V_{GS} = 0\text{ V}$	$V_{DS} = 50\text{ V}$			50	μA
I_{GSS}	$V_{GS} = 20\text{ V}$	$V_{DS} = 0\text{ V}$			250	nA
$V_{GS(Q)}$	$V_{DS} = 10\text{ V}$	$I_D = 250\text{ mA}$	1.5		4	V
$V_{DS(ON)}$	$V_{GS} = 10\text{ V}$	$I_D = 10\text{ A}$			3	V
G_{FS}	$V_{DS} = 10\text{ V}$	$I_D = 5\text{ A}$	5			mho
$\Delta V_{GS}^{(1)}$	$V_{DS} = 10\text{ V}$	$I_D = 250\text{ mA}$			200	mV
C_{ISS}	$V_{GS} = 0\text{ V}$	$V_{DS} = 50\text{ V}$		480		pF
C_{OSS}	$V_{GS} = 0\text{ V}$	$V_{DS} = 50\text{ V}$		190		pF
C_{RSS}	$V_{GS} = 0\text{ V}$	$V_{DS} = 50\text{ V}$		18		pF

1. Absolute V_{GS} difference between side 1 and side 2 of the device

2.2 Dynamic

Table 5. Dynamic

Symbol	Test conditions		Min	Typ	Max	Unit
P_{OUT}	$V_{DD} = 50\text{ V}$	$I_{DQ} = 500\text{ mA}$ $f = 175\text{ MHz}$	300			W
G_{PS}	$V_{DD} = 50\text{ V}, I_{DQ} = 500\text{ mA}, P_{OUT} = 300\text{ W}, f = 175\text{ MHz}$		15	16		dB
h_D	$V_{DD} = 50\text{ V}, I_{DQ} = 500\text{ mA}, P_{OUT} = 300\text{ W}, f = 175\text{ MHz}$		50	60		%
Load mismatch	$V_{DD} = 50\text{ V}, I_{DQ} = 500\text{ mA}, P_{OUT} = 300\text{ W}, f = 175\text{ MHz}$ All phase angles		5:1			VSWR

3 Impedance data

Figure 2. Impedance data

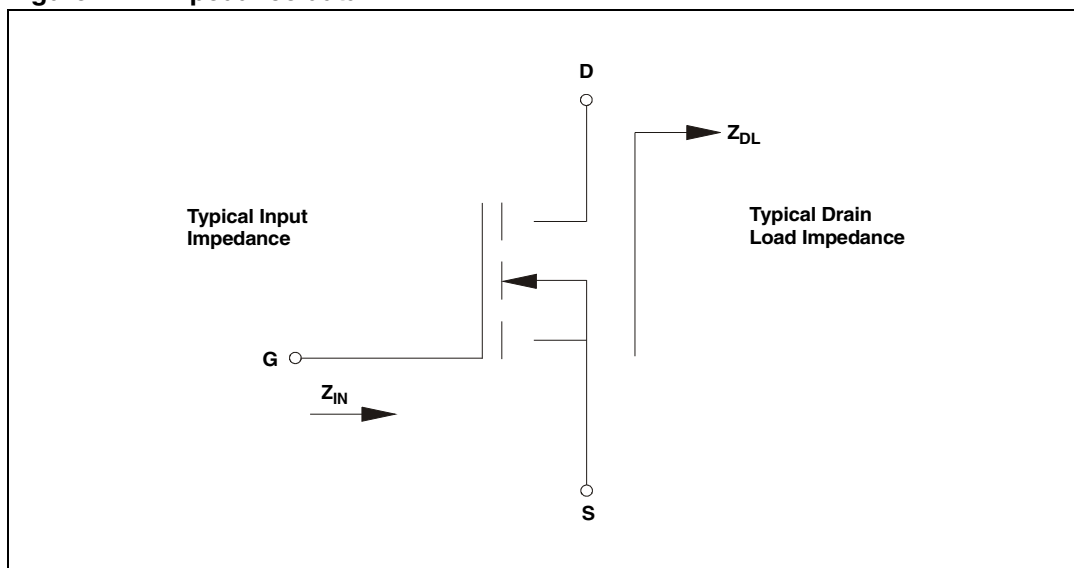

Table 6. Impedance data

Freq	Z_{IN} (Ω)	Z_{DL} (Ω)
175 MHz	$0.92 - j 0.14$	$3.17 + j 4.34$

Note: Measured Gate to Gate and Drain to Drain, respectively.

4 Typical performances

Figure 3. Maximum thermal resistance vs case temperature

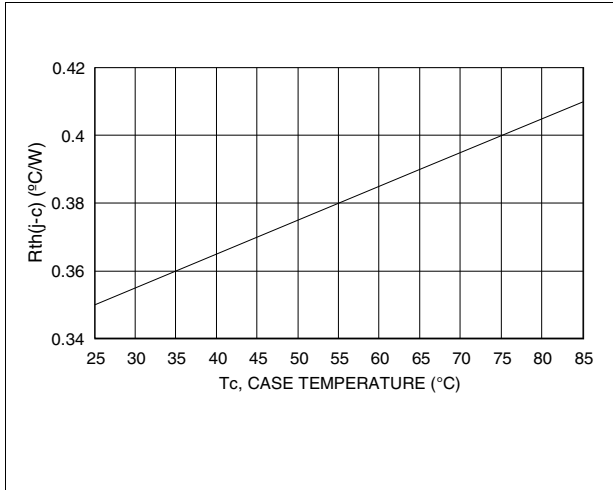

Figure 4. Gate voltage vs case temperature

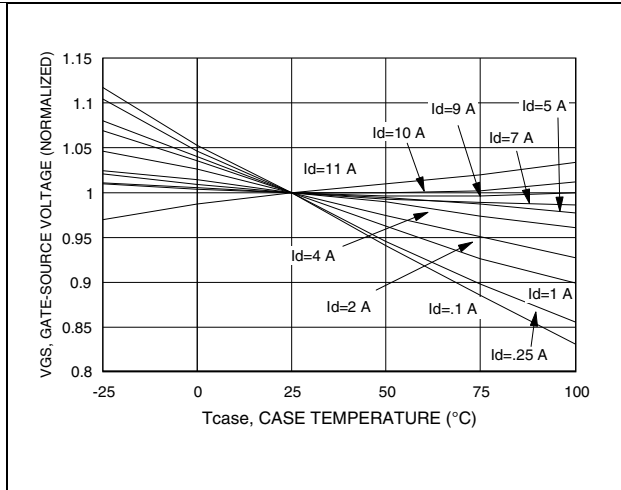

Figure 5. Capacitance vs drain-source voltage

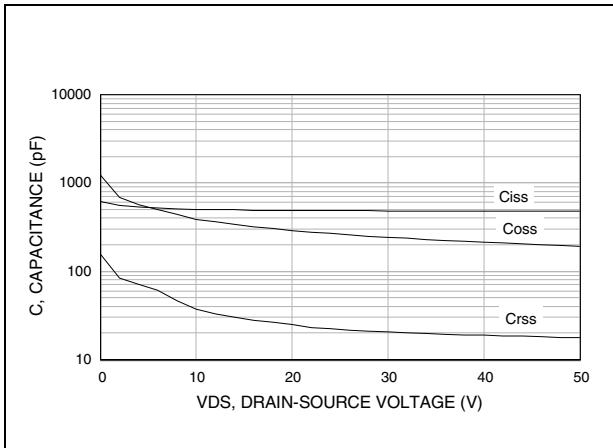

Figure 6. Drain current vs gate voltage

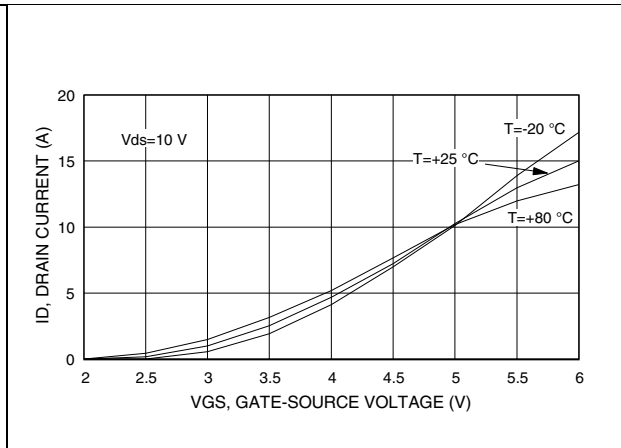

Figure 7. Maximum safe operating area

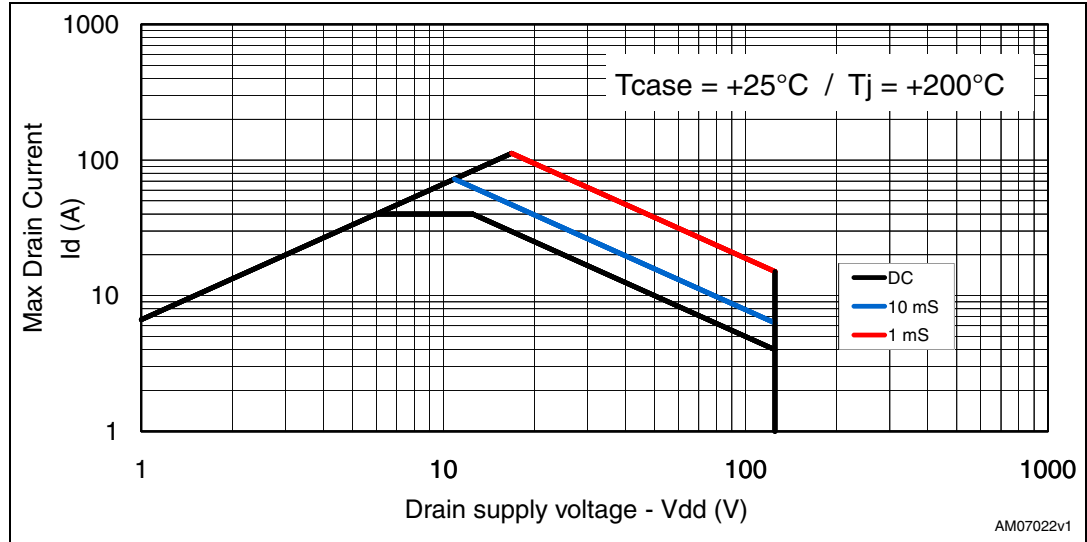

Figure 8. Transient thermal impedance

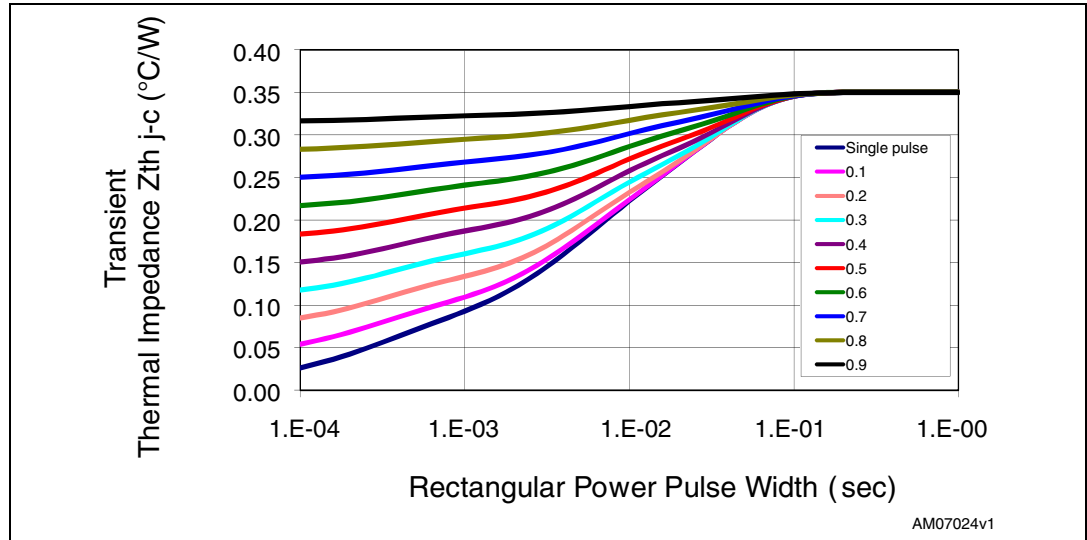
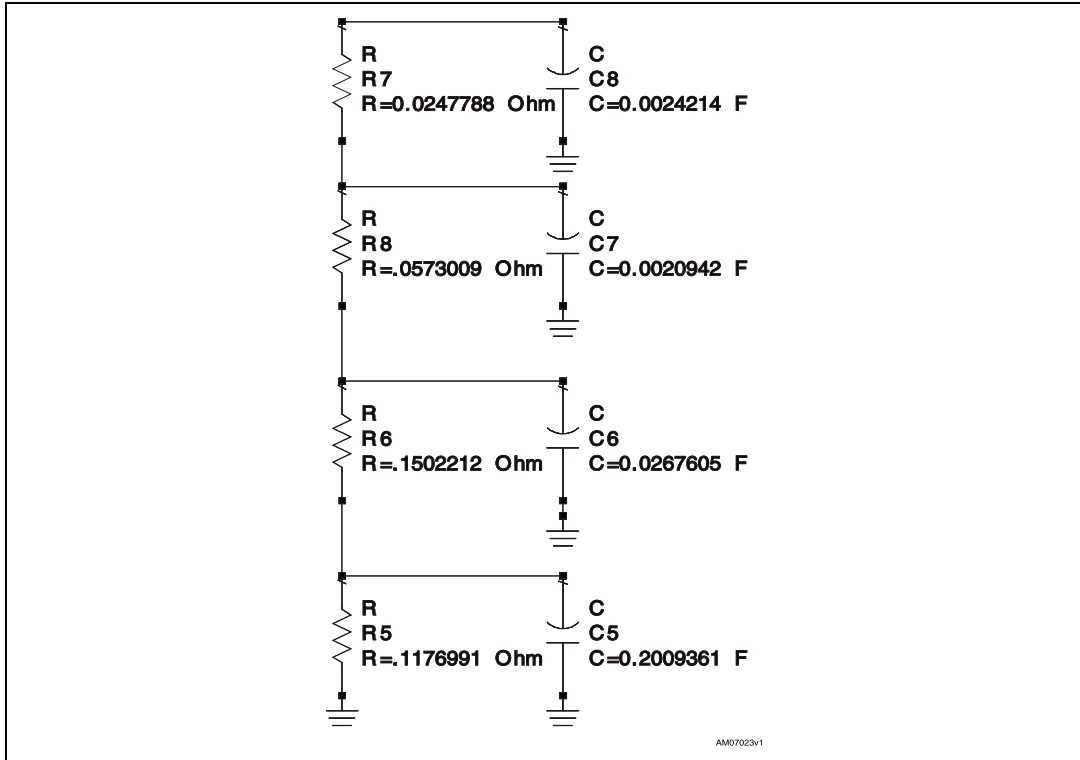

Figure 9. Transient thermal model



4.1 Typical performance (175 MHz)

Figure 10. Output power vs input power

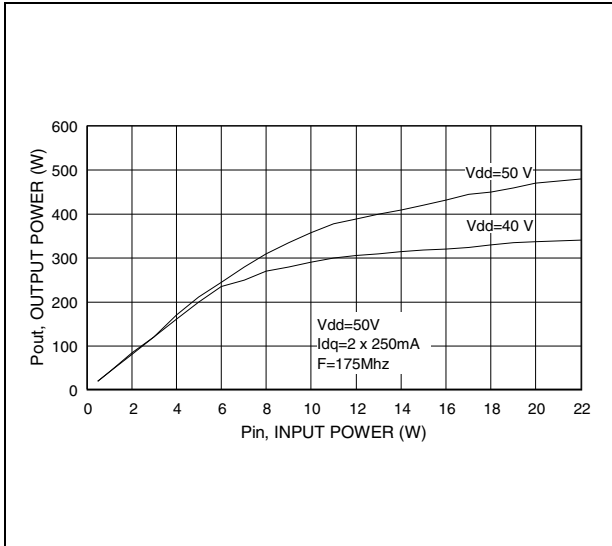

Figure 11. Output power vs input power

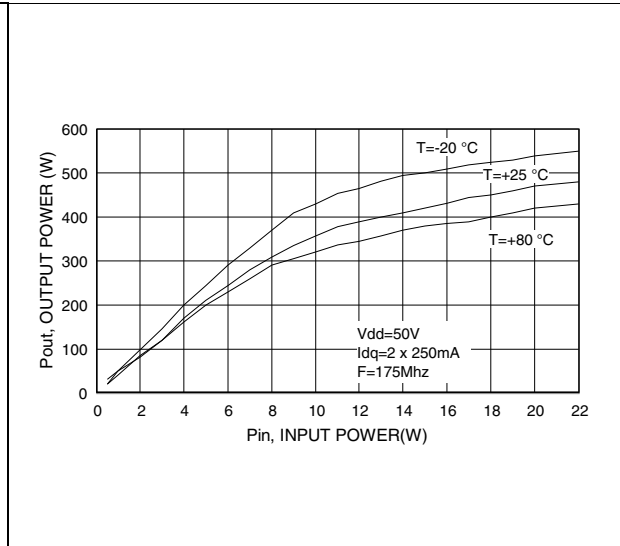

Figure 12. Power gain vs output power

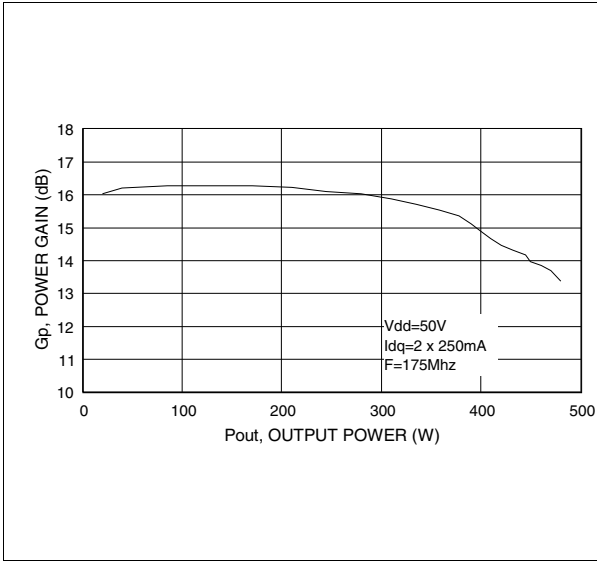

Figure 13. Efficiency vs output power

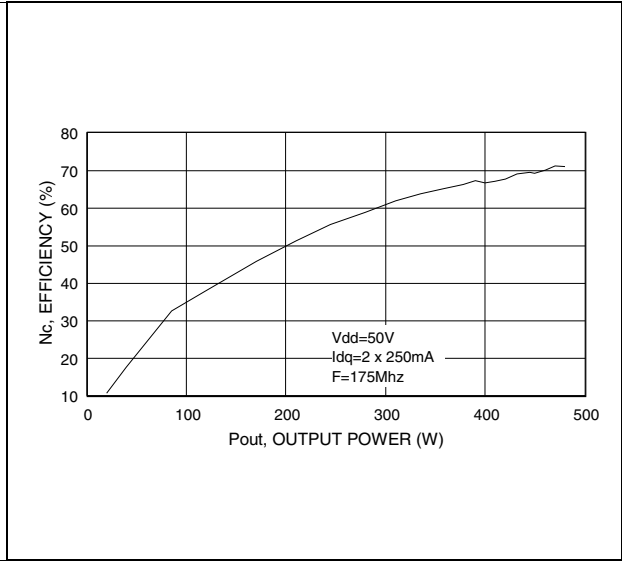

Table 7. Output power vs supply voltage

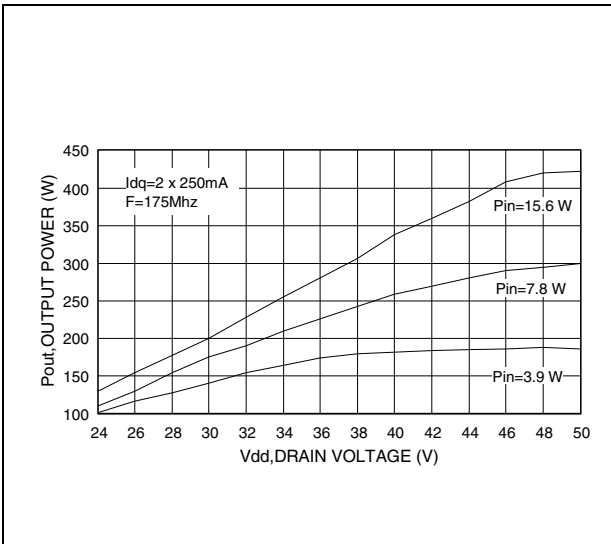
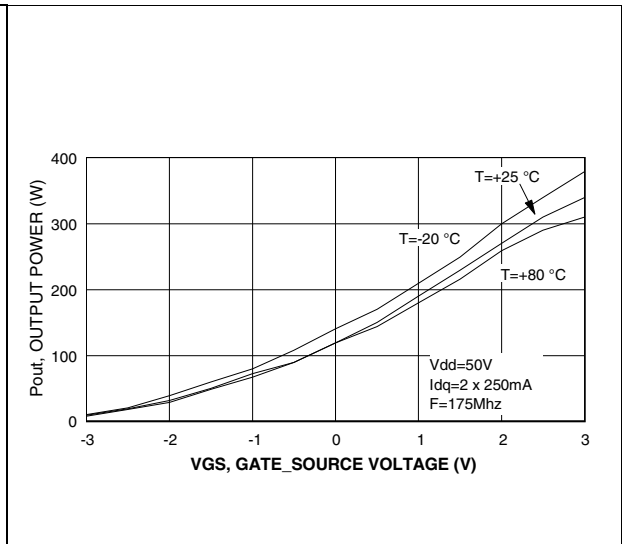

Figure 14. Output power vs gate voltage



5 Test circuit 175 MHz

Figure 15. 175 MHz test circuit schematic (production test circuit)

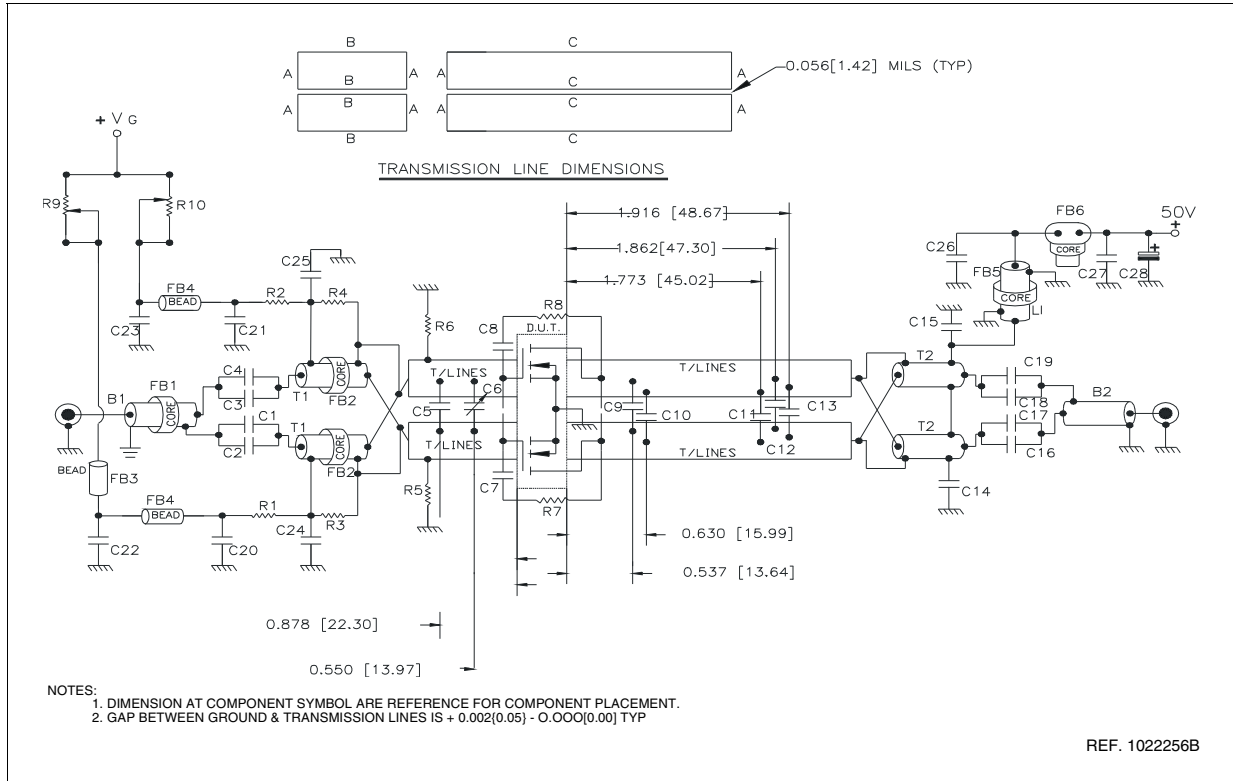

Table 8. 175 MHz test circuit part list

Component	Description
R1,R2,R5,R6	470 Ohm 1 W, surface mount chip resistor
R3,R4	360 Ohm 0.5 W, carbon comp. axial lead resistor or equivalent
R7,R8	560 Ohm 2 W, resistor two turn wire air-wound axial lead resistor
R9,R10	20 K Ohm 3.09 W, 10 turn wirewound precision potentiometer
C1,C4	680 pF ATC 130B surface mount ceramic chip capacitor
C2,C3,C7,C8,C17,C19, C20,C21	10000 pF ATC 200B surface mount ceramic chip capacitor
C5	75 pF ATC 100B surface mount ceramic chip capacitor
C6	ST40 25 pF - 115 pF miniature variable trimmer
C9,C10	47 pF ATC 100B surface mount ceramic chip capacitor
C11,C12, C13	43 pF ATC 100B surface mount ceramic chip capacitor
C14,C15,C24,C25	1200 pF ATC 700B surface mount ceramic chip capacitor
C16,C18	470 pF ATC 700B surface mount ceramic chip capacitor

Table 8. 175 MHz test circuit part list (continued)

Component	Description
C22,C23	0.1 μ F / 500 V surface mount ceramic chip capacitor
C26,C27	0.01 μ F / 500 V surface mount ceramic chip capacitor
C28	10 μ F / 63 aluminum eletrolytic axial lead capacitor
B1	50 Ohm RG316 O.D 0.076[1.93] L = 11.80[299.72] flexible coaxial cable 4 Turns thru ferrite bead
B2	50 Ohm RG-142B O.D 0.165[4.19] L = 11.80[299.72] flexible coaxial cable
T1	R.F. Transformer 4:1, 25 Ohm O.D RG316-25 O.D 0.080[2.03] L = 5.90[149.86] flexible coaxial cable 2 turns thru ferrite multi-aperture core
T2	R.F. transformer 1:4, 25 Ohm semi-rigid coaxial cable O.D. 0.141[3.58] L = 5.90[149.86]
L1	Inductor λ 1/4 wave 50 Ohm O.D 0.165[4.19] L = 11.80 [299.72] flexible coaxial cable 2 turns thru ferrite bead
FB1,FB5	Shield bead
FB2,FB6	Multi-aperture core
FB3	Multilayer ferrite chip bead (surface mount)
FB4	Surface mount EMI shield bead
PCB	Woven glass reinforced PTFE microwave laminate 0.06", 1 oz EDCu, both sides, $\epsilon_r = 2.55$

6 Test circuit photomaster

Figure 16. 175 MHz test circuit photomaster

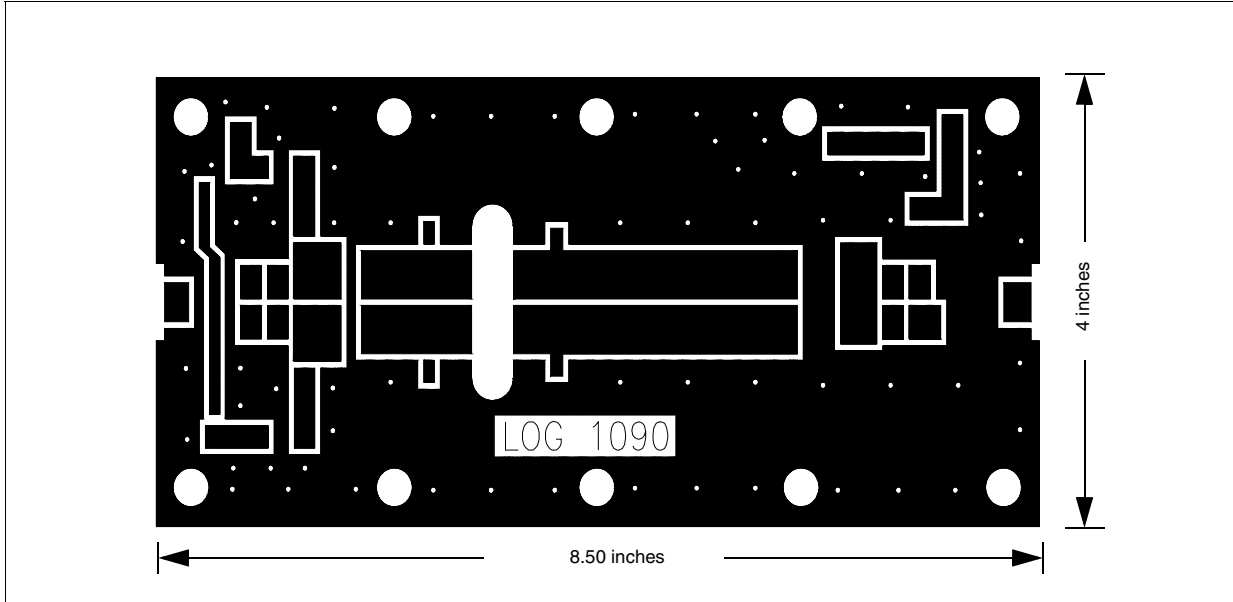
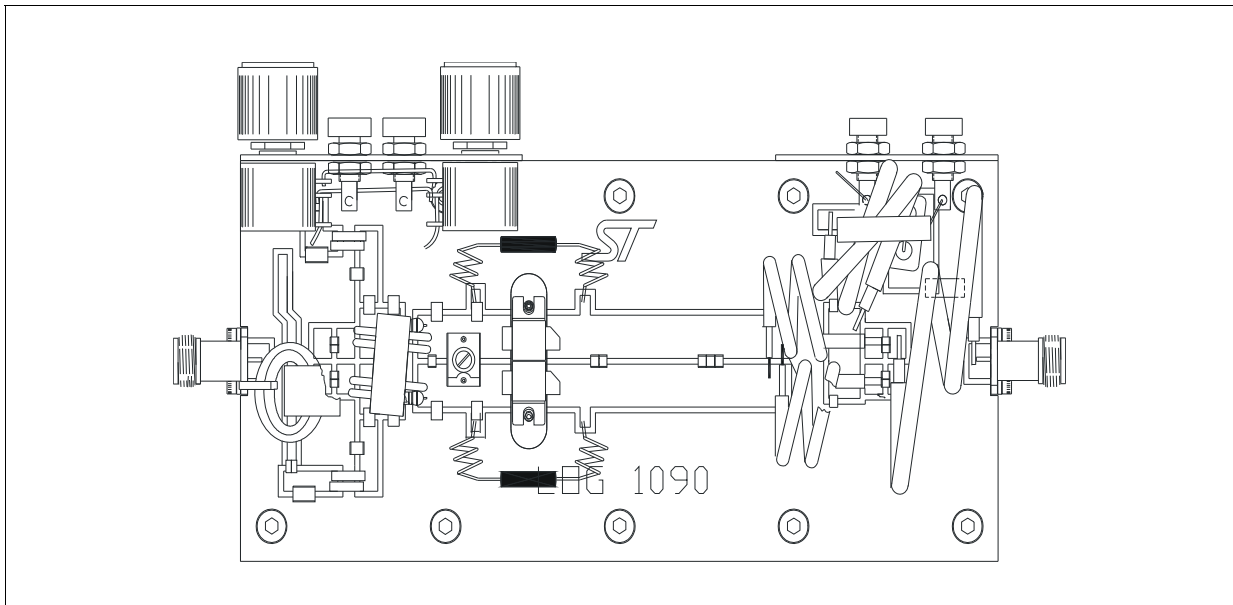

Figure 17. 175 MHz test fixture



7 Typical broadband data (175 - 230 MHz)

Figure 18. Input power vs frequency

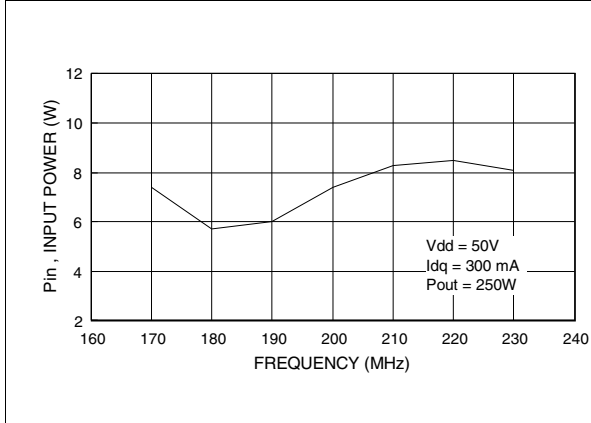

Figure 19. Power gain vs frequency

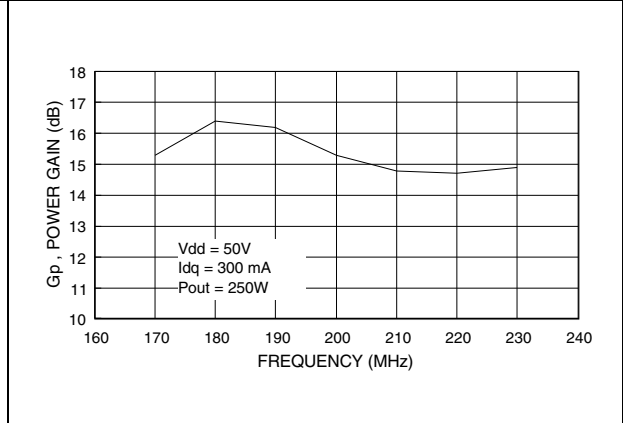

Figure 20. Efficiency vs frequency

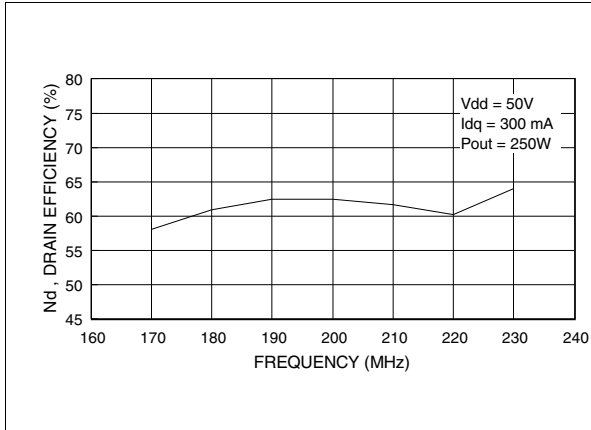

Figure 21. Return loss vs frequency

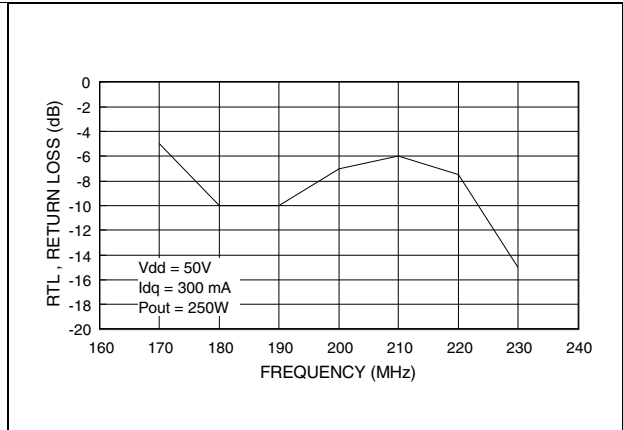
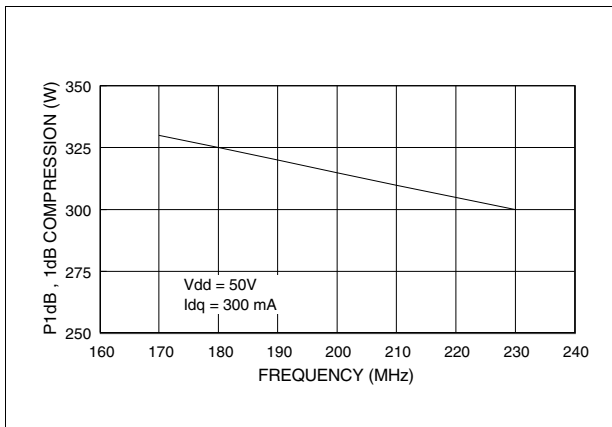

Figure 22. 1 dB compression point vs frequency



8 Test circuit 175 - 230 MHz

Figure 23. 175 - 230 MHz test circuit layout (engineering fixture)

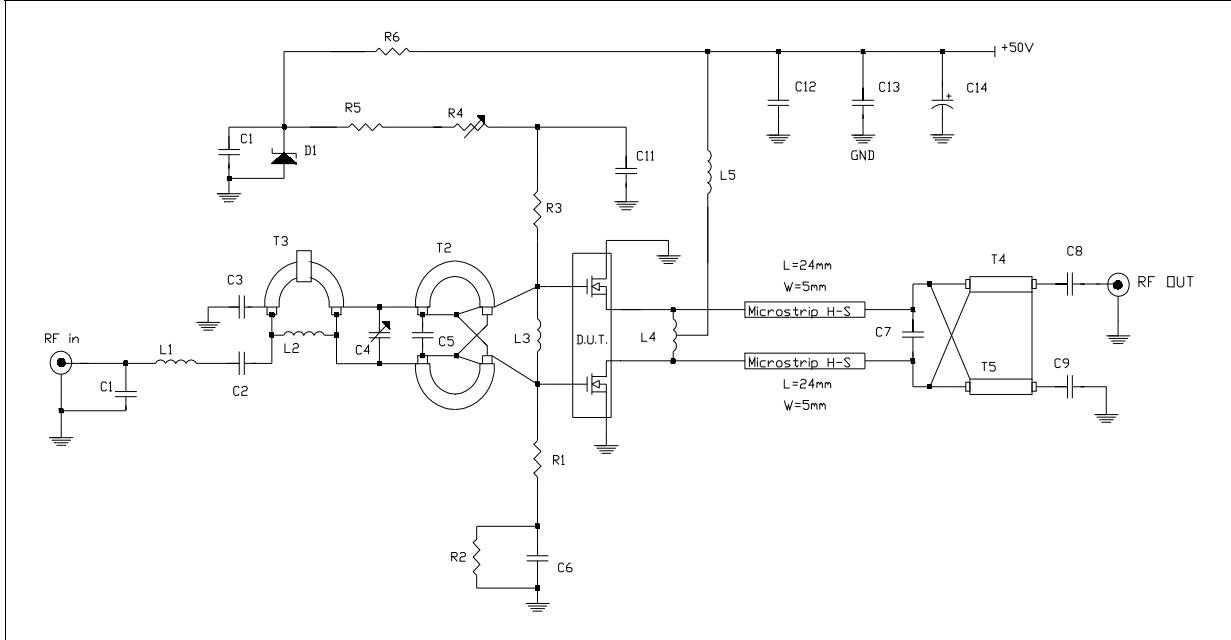

Table 9. 175 - 230 MHz circuit layout component part list

Component	Description
PCB	1/32" woven fiberglass 0.030 Cu, sides, $\epsilon_r = 4.8$
T1	50 Ohm flexible coax cable OD 0.06", 3" long. ferrite Core NEOSIDE
T2,T3	9:1 transformer, 16.5 Ohm flexible coax cable 0.1", 3" Long
T4,T5	4:1 transformer, 25 Ohm flexible coax cable OD 0.06", 5" Long
C1	8.2 pF ceramic cap
C2,C3	100 pF ceramic cap
C4	2 - 18 pF chip cap
C5	47 pF ceramic cap
C6,C11	47 nF ceramic cap
C7	56 pF ATC chip cap
C8,C9,C13	470 pF ATC chip cap
C10	100 nF ceramic cap
C12	2 x 330 nF / 50 V cap
C14	10 nF / 63 V electrolytic cap
R1,R3	47 Ohm resistor
R2	6.8 K Ohm chip resistor

Table 9. 175 - 230 MHz circuit layout component part list (continued)

Component	Description
R4	4.7 K Ohm multi turns trim resistor
R5	8.2 K Ohm / 5 W resistor
R6	3.3 K Ohm / 5 W resistor
D1	6.8 V Zener diode
L1	20 nH Inductor
L2	70 nH Inductor
L3	30 nH Inductor
L4	10 nH Inductor
L5	15 nH Inductor

9 Typical broadband data (88 -108 MHz)

Figure 24. Input power vs frequency

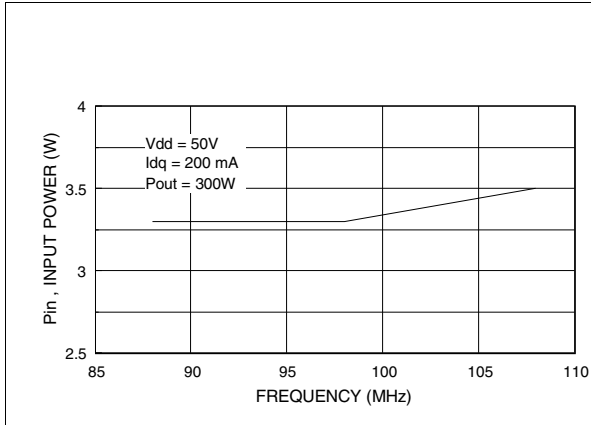

Figure 25. Power gain vs frequency

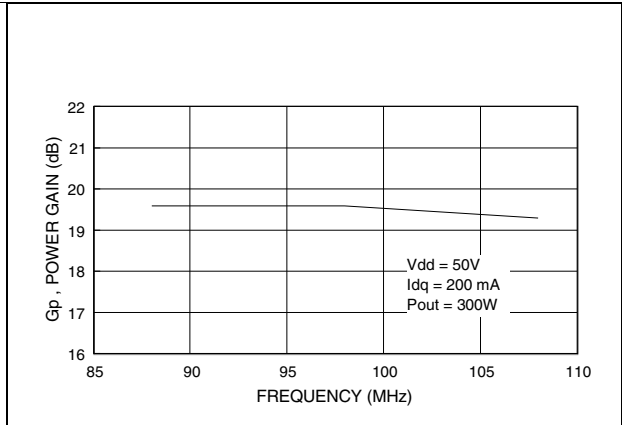

Figure 26. Efficiency vs frequency

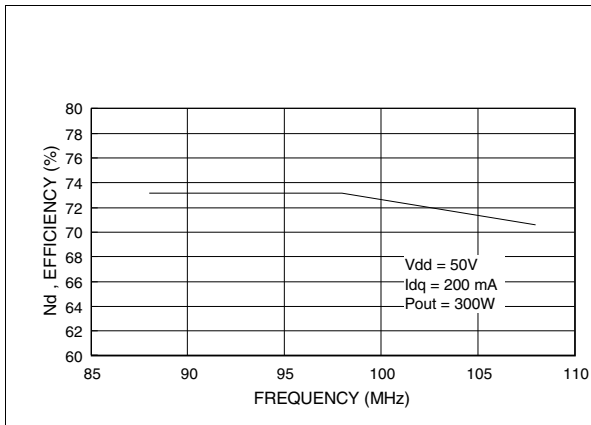

Figure 27. Return loss vs frequency

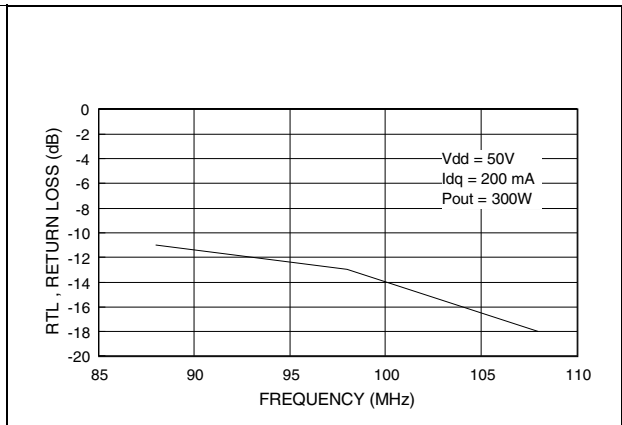

Figure 28. 2nd harmonic vs. frequency (88 - 108 MHz)

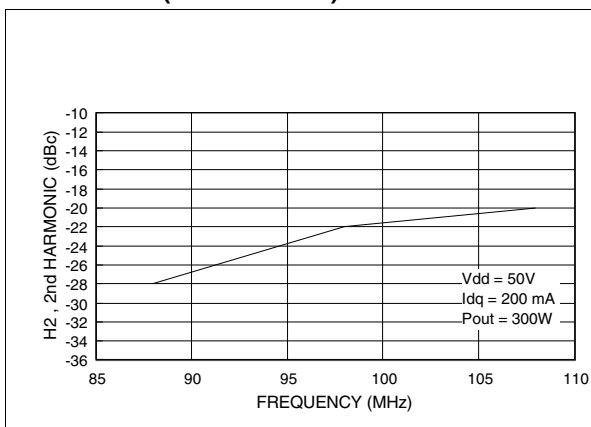
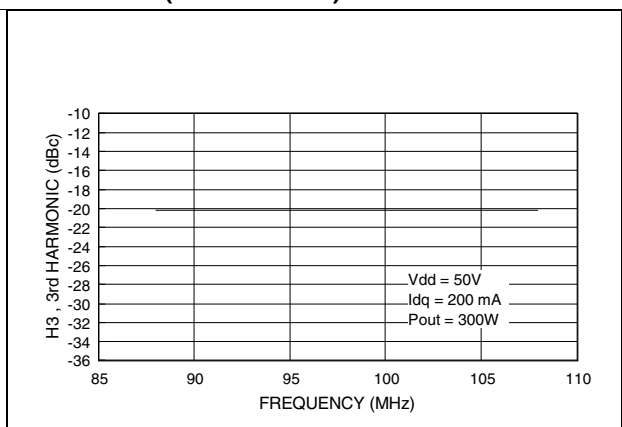

Figure 29. 3rd harmonic vs frequency (88 - 108 MHz)



10 Test circuit 88 - 108 MHz

Figure 30. 88 - 108 MHz test circuit layout (engineering fixture)

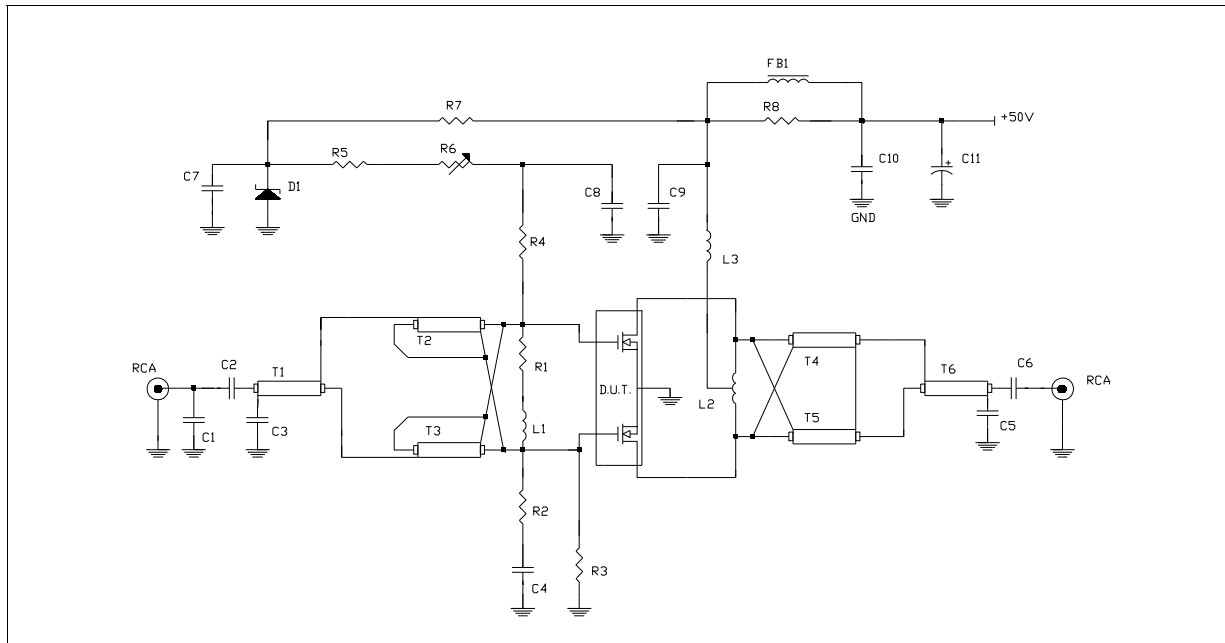

Table 10. 175 - 230 MHz circuit layout component part list

Component	Description
PCB	1/32" woven fiberglass 0.030 Cu, 2 sides, $\epsilon_r = 4.8$
T1	50 Ohm flexible coax cable OD 0.06", 5" Long
T2,T3	9:1 transformer, 25 Ohm flexible coax cable OD 0.1", 3.9". ferrite core NEOSIDE
T4,T5	4:1 transformer, 25 Ohm flexible coax cable OD 0.1", 5" Long
T6	50 Ohm flexible coax cable OD 0.1", 5" long
FB1	vk200
C1	10 pF ceramic cap
C2,C3,C4,C7,C8	1 nF chip cap
C5,C6	1 nF ATC chip cap
C9	470 pF ATC chip cap
C10	100 nF chip cap
C11	100 mF / 63 V electrolytic cap
R1	56 Ohm resistor
R2,R4	10 Ohm chip resistor
R3	10 K Ohm resistor
R5	5.6 Ohm resistor

Table 10. 175 - 230 MHz circuit layout component part list (continued)

Component	Description
R6	10 K Ohm, 10 turn trim resistor
R7	3.3 K Ohm / 5 W resistor
R8	15 Ohm / 5 W resistor
D1	6.6 V Zener diode
L1	10 nH inductor
L2	40 nH inductor
L3	70 nH inductor

11 Package mechanical data

In order to meet environmental requirements, ST offers these devices in different grades of ECOPACK[®] packages, depending on their level of environmental compliance. ECOPACK[®] specifications, grade definitions and product status are available at: www.st.com. ECOPACK is an ST trademark.

Table 11. M244 (.400 x .860 4/L BAL N/HERM W/FLG) mechanical data

Dim.	mm.			Inch		
	Min	Typ	Max	Min	Typ	Max
A	5.59		5.84	0.220		0.230
B		5.08			0.200	
C	3.02		3.28	0.119		0.129
D	9.65		9.91	0.380		0.390
E	19.81		20.82	0.780		0.820
F	10.92		11.18	0.430		0.440
G		27.94			1.100	
H	33.91		34.16	1.335		1.345
I	0.10		0.15	0.004		0.006
J	1.52		1.78	0.060		0.070
K	2.59		2.84	0.102		0.112
L	4.83		5.84	0.190		0.230
M	10.03		10.34	0.395		0.407
N	21.59		22.10	0.850		0.870

Figure 31. Package dimensions

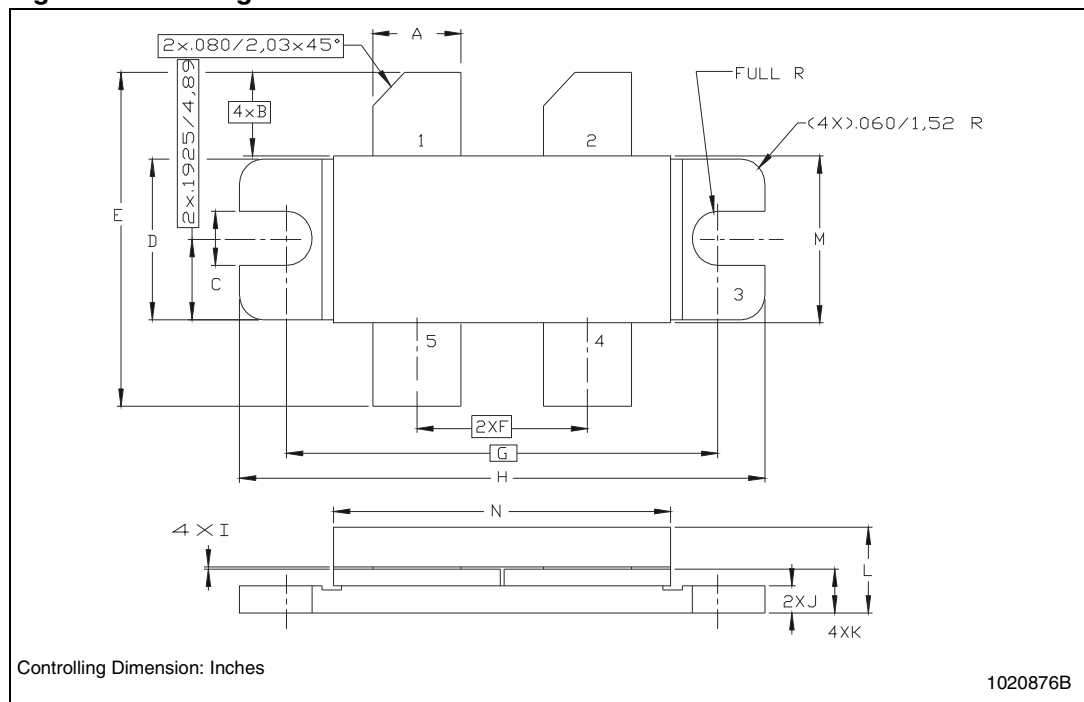

12 Marking, packing and shipping specifications

Table 12. Packing and shipping specifications

Order code	Packaging	Pcs per tray	Dry pack humidity	Lot code
SD2932W	Tube	15	< 10 %	Not mixed

Figure 32. Marking layout

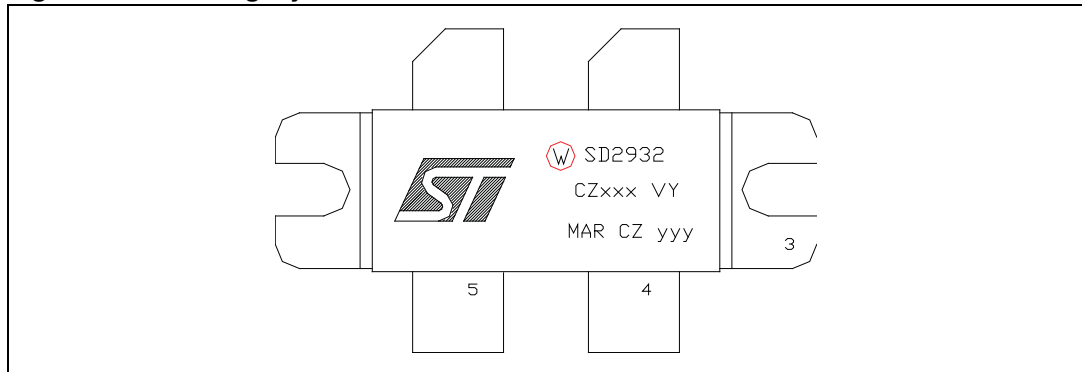

Table 13. Marking specifications

Symbol	Description
W	Wafer process code
CZ	Assy plant
xxx	Last 3 digit of diffusion lot
VY	Diffusion plant
MAR	Country of origin
CZ	Test and finishing plant
y	Assy year
yy	Assy week

13 Revision history

Table 14. Document revision history

Date	Revision	Changes
15-Jul-2004	5	
24-Jan-2006	6	Updated <i>Table 4: Static (per section)</i> .
23-Nov-2009	7	Inserted ΔV_{GS} in <i>Table 4: Static (per section)</i> .
31-Mar-2010	8	Added <i>Figure 7, Figure 8</i> and <i>Figure 9</i> .
11-Jan-2012	9	Inserted <i>Chapter 12: Marking, packing and shipping specifications</i> . Minor text changes.

Please Read Carefully:

Information in this document is provided solely in connection with ST products. STMicroelectronics NV and its subsidiaries ("ST") reserve the right to make changes, corrections, modifications or improvements, to this document, and the products and services described herein at any time, without notice.

All ST products are sold pursuant to ST's terms and conditions of sale.

Purchasers are solely responsible for the choice, selection and use of the ST products and services described herein, and ST assumes no liability whatsoever relating to the choice, selection or use of the ST products and services described herein.

No license, express or implied, by estoppel or otherwise, to any intellectual property rights is granted under this document. If any part of this document refers to any third party products or services it shall not be deemed a license grant by ST for the use of such third party products or services, or any intellectual property contained therein or considered as a warranty covering the use in any manner whatsoever of such third party products or services or any intellectual property contained therein.

UNLESS OTHERWISE SET FORTH IN ST'S TERMS AND CONDITIONS OF SALE ST DISCLAIMS ANY EXPRESS OR IMPLIED WARRANTY WITH RESPECT TO THE USE AND/OR SALE OF ST PRODUCTS INCLUDING WITHOUT LIMITATION IMPLIED WARRANTIES OF MERCHANTABILITY, FITNESS FOR A PARTICULAR PURPOSE (AND THEIR EQUIVALENTS UNDER THE LAWS OF ANY JURISDICTION), OR INFRINGEMENT OF ANY PATENT, COPYRIGHT OR OTHER INTELLECTUAL PROPERTY RIGHT.

UNLESS EXPRESSLY APPROVED IN WRITING BY TWO AUTHORIZED ST REPRESENTATIVES, ST PRODUCTS ARE NOT RECOMMENDED, AUTHORIZED OR WARRANTED FOR USE IN MILITARY, AIR CRAFT, SPACE, LIFE SAVING, OR LIFE SUSTAINING APPLICATIONS, NOR IN PRODUCTS OR SYSTEMS WHERE FAILURE OR MALFUNCTION MAY RESULT IN PERSONAL INJURY, DEATH, OR SEVERE PROPERTY OR ENVIRONMENTAL DAMAGE. ST PRODUCTS WHICH ARE NOT SPECIFIED AS "AUTOMOTIVE GRADE" MAY ONLY BE USED IN AUTOMOTIVE APPLICATIONS AT USER'S OWN RISK.

Resale of ST products with provisions different from the statements and/or technical features set forth in this document shall immediately void any warranty granted by ST for the ST product or service described herein and shall not create or extend in any manner whatsoever, any liability of ST.

ST and the ST logo are trademarks or registered trademarks of ST in various countries.

Information in this document supersedes and replaces all information previously supplied.

The ST logo is a registered trademark of STMicroelectronics. All other names are the property of their respective owners.

© 2012 STMicroelectronics - All rights reserved

STMicroelectronics group of companies

Australia - Belgium - Brazil - Canada - China - Czech Republic - Finland - France - Germany - Hong Kong - India - Israel - Italy - Japan - Malaysia - Malta - Morocco - Philippines - Singapore - Spain - Sweden - Switzerland - United Kingdom - United States of America

www.st.com

