



# STGW50HF60SD

60 A, 600 V, very low drop IGBT with soft and fast recovery diode

## Features

- Very low on-state voltage drop
- Low switching off
- High current capability
- Very soft ultra fast recovery antiparallel diode

## Application

- PV inverter
- UPS

## Description

STGW50HF60SD is a very low drop IGBT based on new advanced planar technology, showing extremely low on-state voltage and limited turn-off losses. The overall performance makes this IGBT ideal in low frequency switches of mixed frequency topologies for  $PF \leq 1$ .

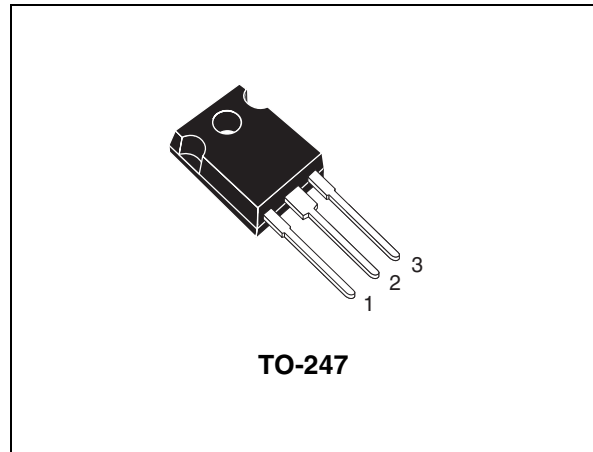

Figure 1. Internal schematic diagram

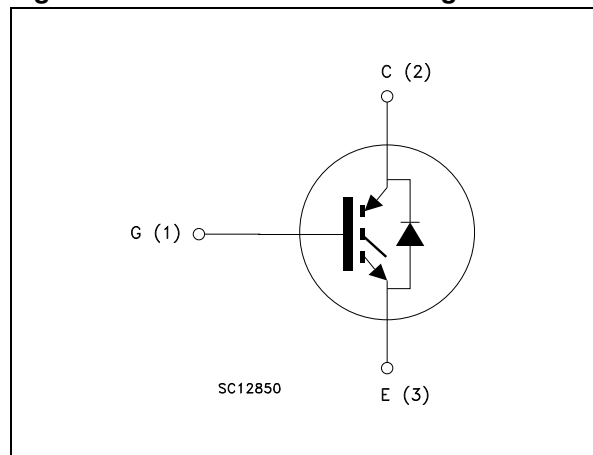

Table 1. Device summary

Order code	Marking	Package	Packaging
STGW50HF60SD	GW50HF60SD	TO-247	Tube

# 1 Electrical ratings

**Table 2. Absolute maximum ratings**

Symbol	Parameter	Value	Unit
$V_{CES}$	Collector-emitter voltage ( $V_{GE} = 0$ )	600	V
$I_C^{(1)}$	Continuous collector current at $T_C = 25\text{ °C}$	110	A
$I_C^{(1)}$	Continuous collector current at $T_C = 100\text{ °C}$	60	A
$I_{CL}^{(2)}$	Turn-off latching current	60	A
$I_{CP}^{(3)}$	Pulsed collector current	130	A
$V_{GE}$	Gate-emitter voltage	$\pm 20$	V
$P_{TOT}$	Total dissipation at $T_C = 25\text{ °C}$	284	W
$I_F$	Diode RMS forward current at $T_C = 25\text{ °C}$	30	A
$I_{FSM}$	Surge non repetitive forward current $t_p = 10\text{ ms}$ sinusoidal	120	A
$T_j$	Operating junction temperature	- 55 to 150	°C

1. Calculated according to the iterative formula:

$$I_C(T_C) = \frac{T_{j(max)} - T_C}{R_{thj-c} \times V_{CE(sat)(max)}(T_{j(max)}, I_C(T_C))}$$

2.  $V_{clamp} = 80\%$  of  $V_{CES}$ ,  $T_j = 150\text{ °C}$ ,  $R_G = 10\ \Omega$ ,  $V_{GE} = 15\text{ V}$   
 3. Pulse width limited by maximum junction temperature and turn-off within RBSOA

**Table 3. Thermal data**

Symbol	Parameter	Value	Unit
$R_{thj-case}$	Thermal resistance junction-case IGBT	0.44	°C/W
$R_{thj-case}$	Thermal resistance junction-case diode	1.25	°C/W
$R_{thj-amb}$	Thermal resistance junction-ambient	50	°C/W

## 2 Electrical characteristics

( $T_J=25^\circ\text{C}$  unless otherwise specified)

**Table 4. Static**

Symbol	Parameter	Test conditions	Min.	Typ.	Max.	Unit
$V_{(BR)CES}$	Collector-emitter breakdown voltage ( $V_{GE} = 0$ )	$I_C = 1 \text{ mA}$	600			V
$V_{CE(sat)}$	Collector-emitter saturation voltage	$V_{GE} = 15 \text{ V}, I_C = 30 \text{ A}$		1.15	1.45	V
		$V_{GE} = 15 \text{ V}, I_C = 30 \text{ A}, T_J = 125^\circ\text{C}$		1.05		V
$V_{GE(th)}$	Gate threshold voltage	$V_{CE} = V_{GE}, I_C = 250 \mu\text{A}$	3.5		5.7	V
$I_{CES}$	Collector cut-off current ( $V_{GE} = 0$ )	$V_{CE} = 600 \text{ V}$			50	$\mu\text{A}$
		$V_{CE} = 600 \text{ V}, T_J = 125^\circ\text{C}$			500	$\mu\text{A}$
$I_{GES}$	Gate-emitter leakage current ( $V_{CE} = 0$ )	$V_{GE} = \pm 20 \text{ V}$			$\pm 100$	nA
$g_{fs}$	Forward transconductance	$V_{CE} = 15 \text{ V}, I_C = 30 \text{ A}$		25		S

**Table 5. Dynamic**

Symbol	Parameter	Test conditions	Min.	Typ.	Max.	Unit
$C_{ies}$ $C_{oes}$ $C_{res}$	Input capacitance	$V_{CE} = 25 \text{ V}, f = 1 \text{ MHz}, V_{GE} = 0$		4300		pF
	Output capacitance		-	400	-	pF
	Reverse transfer capacitance			100		pF
$Q_g$ $Q_{ge}$ $Q_{gc}$	Total gate charge	$V_{CE} = 480 \text{ V}, I_C = 30 \text{ A}, V_{GE} = 15 \text{ V}$		200		nC
	Gate-emitter charge		-	27	-	nC
	Gate-collector charge			90		nC

**Table 6. Switching on/off (inductive load)**

Symbol	Parameter	Test conditions	Min.	Typ.	Max.	Unit
$t_{d(on)}$ $t_r$ $(di/dt)_{on}$	Turn-on delay time Current rise time Turn-on current slope	$V_{CC} = 400\text{ V}$ , $I_C = 30\text{ A}$ $R_G = 10\ \Omega$ , $V_{GE} = 15\text{ V}$ , (see Figure 15)	-	50 20 1280	-	ns ns A/ $\mu$ s
$t_{d(on)}$ $t_r$ $(di/dt)_{on}$	Turn-on delay time Current rise time Turn-on current slope	$V_{CC} = 400\text{ V}$ , $I_C = 30\text{ A}$ $R_G = 10\ \Omega$ , $V_{GE} = 15\text{ V}$ , $T_J = 125\text{ }^\circ\text{C}$ (see Figure 15)	-	47 22 1100	-	ns ns A/ $\mu$ s
$t_r(V_{off})$ $t_{d(off)}$ $t_f$	Off voltage rise time Turn-off delay time Current fall time	$V_{CC} = 400\text{ V}$ , $I_C = 30\text{ A}$ $R_G = 10\ \Omega$ , $V_{GE} = 15\text{ V}$ , (see Figure 15)	-	370 220 465	-	ns ns ns
$t_r(V_{off})$ $t_{d(off)}$ $t_f$	Off voltage rise time Turn-off delay time Current fall time	$V_{CC} = 400\text{ V}$ , $I_C = 30\text{ A}$ $R_G = 10\ \Omega$ , $V_{GE} = 15\text{ V}$ , $T_J = 125\text{ }^\circ\text{C}$ (see Figure 15)	-	700 250 800	-	ns ns ns

**Table 7. Switching energy (inductive load)**

Symbol	Parameter	Test conditions	Min.	Typ.	Max.	Unit
$E_{on}^{(1)}$ $E_{off}^{(2)}$ $E_{ts}$	Turn-on switching losses Turn-off switching losses Total switching losses	$V_{CC} = 400\text{ V}$ , $I_C = 30\text{ A}$ $R_G = 10\ \Omega$ , $V_{GE} = 15\text{ V}$ , (see Figure 15)	-	0.25 4.2 4.45	-	mJ mJ mJ
$E_{on}^{(1)}$ $E_{off}^{(2)}$ $E_{ts}$	Turn-on switching losses Turn-off switching losses Total switching losses	$V_{CC} = 400\text{ V}$ , $I_C = 30\text{ A}$ $R_G = 10\ \Omega$ , $V_{GE} = 15\text{ V}$ , $T_J = 125\text{ }^\circ\text{C}$ (see Figure 15)	-	0.45 7.8 8.25	-	mJ mJ mJ

1.  $E_{on}$  is the turn-on losses when a typical diode is used in the test circuit in Figure 15. If the IGBT is offered in a package with a co-pack diode, the co-pack diode is used as external diode. IGBTs and diode are at the same temperature (25°C and 125°C).
2. Turn-off losses include also the tail of the collector current.

**Table 8. Collector-emitter diode**

Symbol	Parameter	Test conditions	Min.	Typ.	Max.	Unit
$V_F$	Forward on-voltage	$I_F = 30\text{ A}$ $I_F = 30\text{ A}$ , $T_J = 125\text{ }^\circ\text{C}$	-	2.8 1.8	-	V V
$t_{rr}$ $Q_{rr}$ $I_{rrm}$	Reverse recovery time Reverse recovery charge Reverse recovery current	$I_F = 30\text{ A}$ , $V_R = 50\text{ V}$ , $di/dt = 100\text{ A}/\mu\text{s}$ (see Figure 18)	-	67 140 4	-	ns nC A
$t_{rr}$ $Q_{rr}$ $I_{rrm}$	Reverse recovery time Reverse recovery charge Reverse recovery current	$I_F = 30\text{ A}$ , $V_R = 50\text{ V}$ , $T_J = 125\text{ }^\circ\text{C}$ , $di/dt = 100\text{ A}/\mu\text{s}$ (see Figure 18)	-	103 390 7	-	ns nC A

## 2.1 Electrical characteristics (curves)

Figure 2. Output characteristics

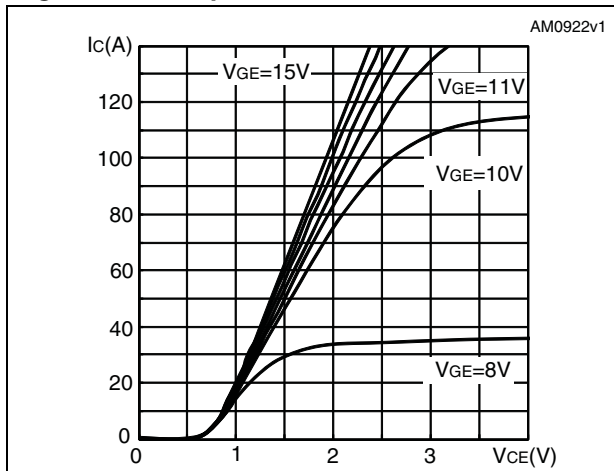

Figure 3. Transfer characteristics

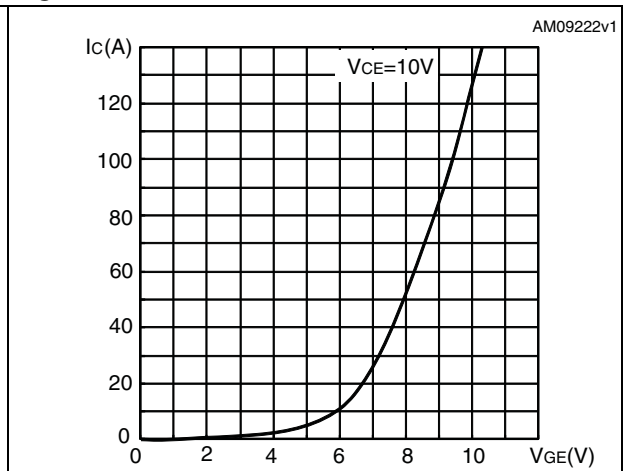

Figure 4. Collector-emitter on voltage vs temperature

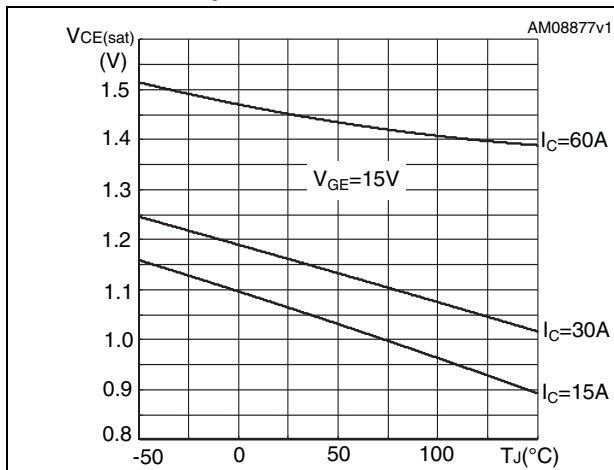

Figure 5. Collector-emitter on voltage vs collector current

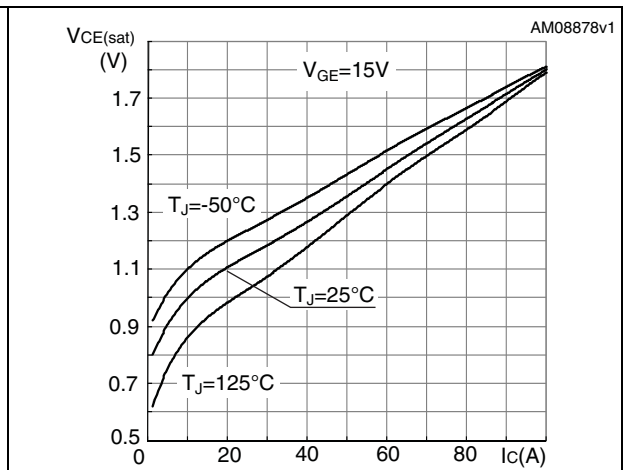

Figure 6. Breakdown voltage vs temperature

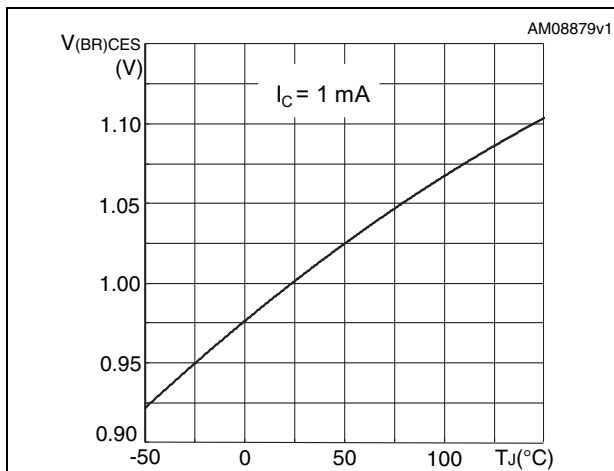

Figure 7. Gate threshold voltage vs temperature

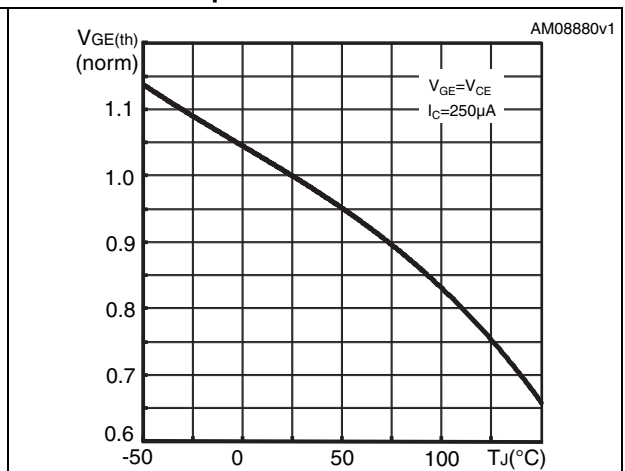

Figure 8. Gate charge vs gate-emitter voltage Figure 9. Capacitance variations

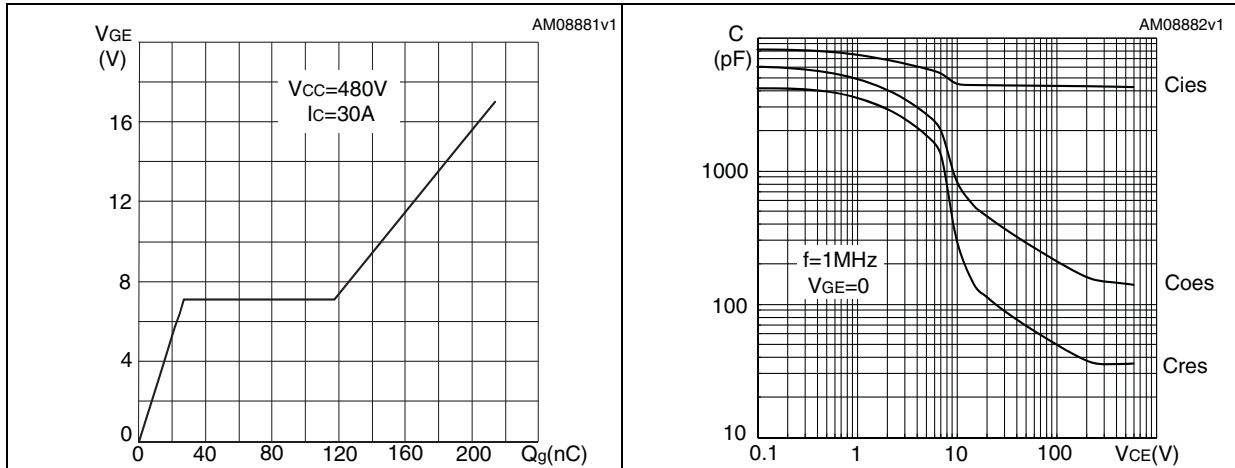

Figure 10. Switching losses vs collector current

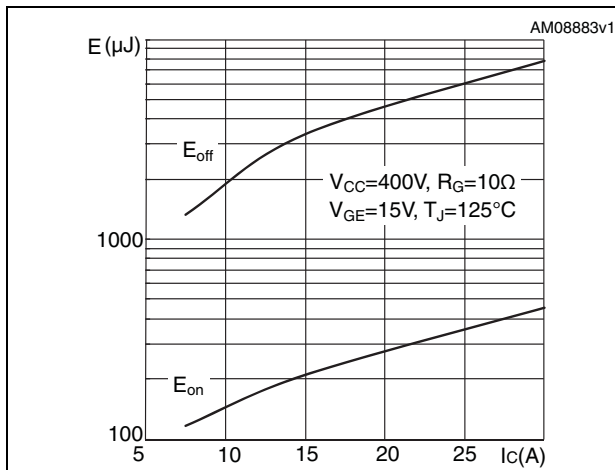

Figure 11. Switching losses vs gate resistance

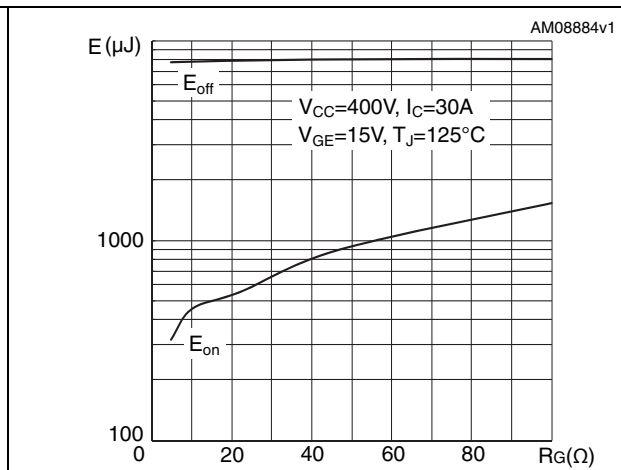

Figure 12. Switching losses vs temperature

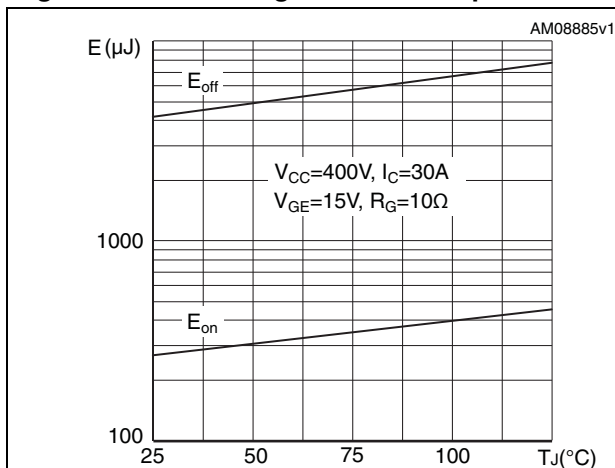
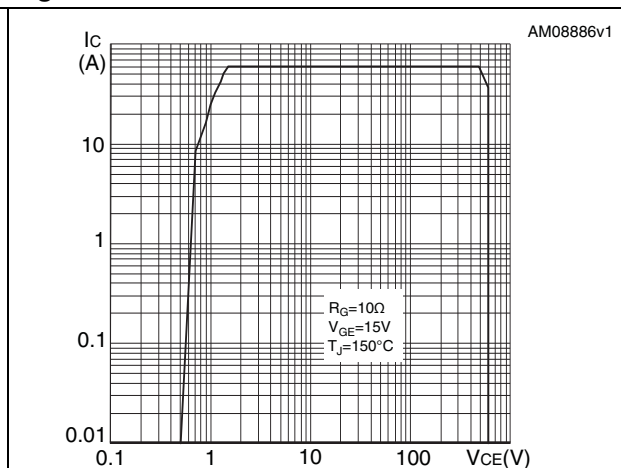
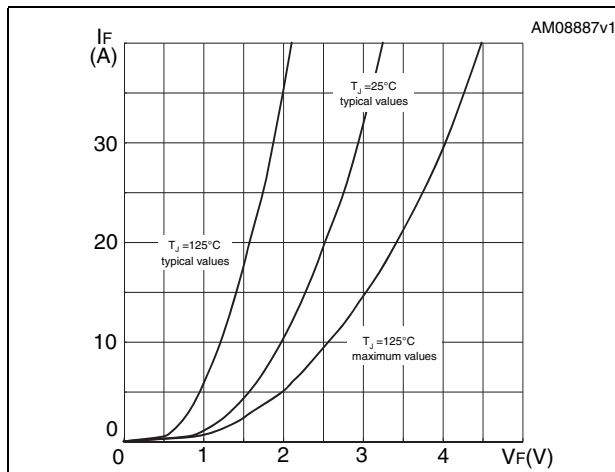

Figure 13. Turn-off SOA



**Figure 14. Emitter-collector diode characteristics**





## 4 Package mechanical data

In order to meet environmental requirements, ST offers these devices in different grades of ECOPACK<sup>®</sup> packages, depending on their level of environmental compliance. ECOPACK<sup>®</sup> specifications, grade definitions and product status are available at: [www.st.com](http://www.st.com). ECOPACK is an ST trademark.

Table 9. TO-247 mechanical data

Dim.	mm		
	Min.	Typ.	Max.
A	4.85		5.15
A1	2.20		2.60
b	1.0		1.40
b1	2.0		2.40
b2	3.0		3.40
c	0.40		0.80
D	19.85		20.15
E	15.45		15.75
e		5.45	
L	14.20		14.80
L1	3.70		4.30
L2		18.50	
ØP	3.55		3.65
ØR	4.50		5.50
S		5.50	

Figure 19. TO-247 drawing

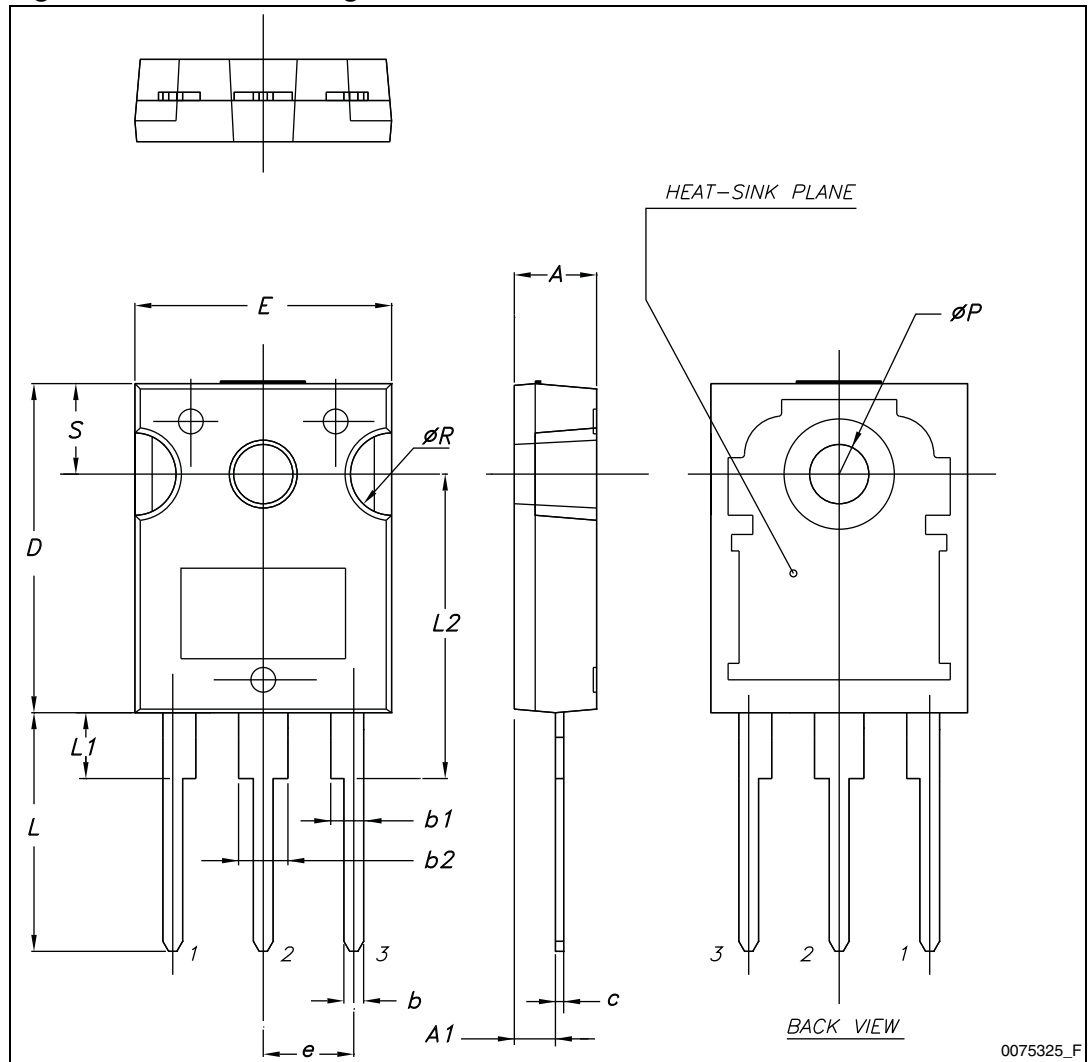

0075325\_F

## 5 Revision history

**Table 10. Document revision history**

Date	Revision	Changes
15-Jan-2010	1	Initial release.
21-Dec-2010	2	Document status promoted to datasheet.

**Please Read Carefully:**

Information in this document is provided solely in connection with ST products. STMicroelectronics NV and its subsidiaries ("ST") reserve the right to make changes, corrections, modifications or improvements, to this document, and the products and services described herein at any time, without notice.

All ST products are sold pursuant to ST's terms and conditions of sale.

Purchasers are solely responsible for the choice, selection and use of the ST products and services described herein, and ST assumes no liability whatsoever relating to the choice, selection or use of the ST products and services described herein.

No license, express or implied, by estoppel or otherwise, to any intellectual property rights is granted under this document. If any part of this document refers to any third party products or services it shall not be deemed a license grant by ST for the use of such third party products or services, or any intellectual property contained therein or considered as a warranty covering the use in any manner whatsoever of such third party products or services or any intellectual property contained therein.

**UNLESS OTHERWISE SET FORTH IN ST'S TERMS AND CONDITIONS OF SALE ST DISCLAIMS ANY EXPRESS OR IMPLIED WARRANTY WITH RESPECT TO THE USE AND/OR SALE OF ST PRODUCTS INCLUDING WITHOUT LIMITATION IMPLIED WARRANTIES OF MERCHANTABILITY, FITNESS FOR A PARTICULAR PURPOSE (AND THEIR EQUIVALENTS UNDER THE LAWS OF ANY JURISDICTION), OR INFRINGEMENT OF ANY PATENT, COPYRIGHT OR OTHER INTELLECTUAL PROPERTY RIGHT.**

**UNLESS EXPRESSLY APPROVED IN WRITING BY AN AUTHORIZED ST REPRESENTATIVE, ST PRODUCTS ARE NOT RECOMMENDED, AUTHORIZED OR WARRANTED FOR USE IN MILITARY, AIR CRAFT, SPACE, LIFE SAVING, OR LIFE SUSTAINING APPLICATIONS, NOR IN PRODUCTS OR SYSTEMS WHERE FAILURE OR MALFUNCTION MAY RESULT IN PERSONAL INJURY, DEATH, OR SEVERE PROPERTY OR ENVIRONMENTAL DAMAGE. ST PRODUCTS WHICH ARE NOT SPECIFIED AS "AUTOMOTIVE GRADE" MAY ONLY BE USED IN AUTOMOTIVE APPLICATIONS AT USER'S OWN RISK.**

Resale of ST products with provisions different from the statements and/or technical features set forth in this document shall immediately void any warranty granted by ST for the ST product or service described herein and shall not create or extend in any manner whatsoever, any liability of ST.

ST and the ST logo are trademarks or registered trademarks of ST in various countries.

Information in this document supersedes and replaces all information previously supplied.

The ST logo is a registered trademark of STMicroelectronics. All other names are the property of their respective owners.

© 2010 STMicroelectronics - All rights reserved

STMicroelectronics group of companies

Australia - Belgium - Brazil - Canada - China - Czech Republic - Finland - France - Germany - Hong Kong - India - Israel - Italy - Japan - Malaysia - Malta - Morocco - Philippines - Singapore - Spain - Sweden - Switzerland - United Kingdom - United States of America

[www.st.com](http://www.st.com)