

## Filter-free stereo 2x2.8 W class D audio power amplifier

Datasheet - production data

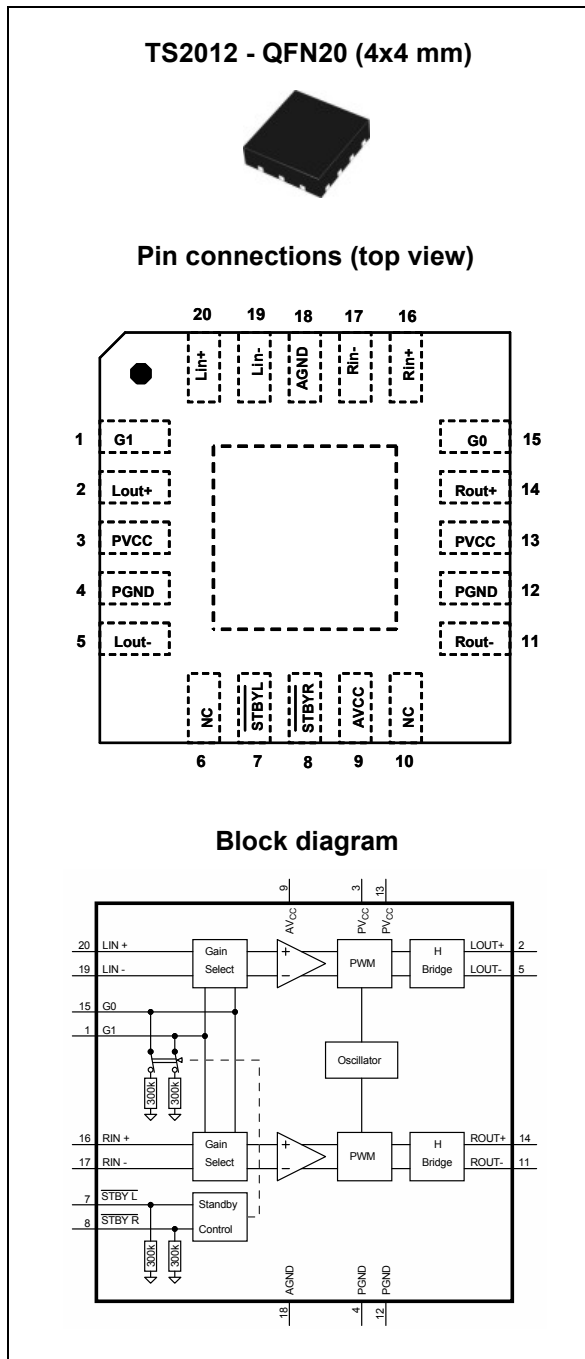

### Features

- Operating range from  $V_{CC} = 2.5\text{ V}$  to  $5.5\text{ V}$
- Standby mode active low
- Output power per channel:  $1.35\text{ W @ }5\text{ V}$  or  $0.68\text{ W @ }3.6\text{ V}$  into  $8\ \Omega$  with 1 % THD+N max
- Output power per channel:  $2.2\text{ W @ }5\text{ V}$  into  $4\ \Omega$  with 1 % THD+N max
- Four gains can be selected: 6, 12, 18, 24 dB
- Low current consumption
- PSRR: 70 dB typ @ 217 Hz with 6 dB gain
- Fast startup phase: 1 ms
- Thermal shutdown protection
- QFN20 4x4 mm lead-free package

### Applications

- Cellular phone
- PDA
- Flat panel TV

### Description

The TS2012 is a fully differential, class D, power amplifier stereo. It is able to drive up to  $1.35\text{ W}$  into an  $8\ \Omega$  load at  $5\text{ V}$  per channel. It achieves outstanding efficiency compared to typical class AB audio amps.

The device has four different gain settings utilizing two discrete pins: G0 and G1.

Pop and click reduction circuitry provides low on/off switch noise while allowing the device to start within 1 ms.

Two standby pins (active low) allow each channel to be switched off independently.

The TS2012 is available in a QFN20 4x4 mm package.

# Contents

- 1 Absolute maximum ratings and operating conditions ..... 3**
- 2 Typical application ..... 5**
- 3 Electrical characteristics ..... 7**
  - 3.1 Electrical characteristic tables ..... 7
  - 3.2 Electrical characteristic curves ..... 12
- 4 Application information ..... 21**
  - 4.1 Differential configuration principle ..... 21
  - 4.2 Gain settings ..... 21
  - 4.3 Common mode feedback loop limitations ..... 21
  - 4.4 Low frequency response ..... 22
  - 4.5 Decoupling of the circuit ..... 22
  - 4.6 Wakeup time ( $t_{wu}$ ) ..... 23
  - 4.7 Shutdown time ..... 23
  - 4.8 Consumption in shutdown mode ..... 23
  - 4.9 Single-ended input configuration ..... 24
  - 4.10 Output filter considerations ..... 24
- 5 Package information ..... 26**
  - 5.1 QFN20 package information ..... 26
- 6 Ordering information ..... 28**
- 7 Revision history ..... 28**

# 1 Absolute maximum ratings and operating conditions

**Table 1. Absolute maximum ratings**

Symbol	Parameter	Value	Unit
$V_{CC}$	Supply voltage <sup>(1)</sup>	6	V
$V_i$	Input voltage <sup>(2)</sup>	GND to $V_{CC}$	
$T_{oper}$	Operating free air temperature range	-40 to + 85	°C
$T_{stg}$	Storage temperature	-65 to +150	
$T_j$	Maximum junction temperature	150	
$R_{thja}$	Thermal resistance junction to ambient <sup>(3)</sup>	100	°C/W
$P_d$	Power dissipation	Internally limited <sup>(4)</sup>	
ESD	HBM: human body model <sup>(5)</sup>	2	kV
	MM: machine model <sup>(6)</sup>	200	V
Latch-up	Latch-up immunity	200	mA
$V_{STBY}$	Standby pin voltage maximum voltage	GND to $V_{CC}$	V
	Lead temperature (soldering, 10 s)	260	°C

1. All voltage values are measured with respect to the ground pin.
2. The magnitude of the input signal must never exceed  $V_{CC} + 0.3\text{ V}$  / GND - 0.3 V.
3. The device is protected in case of over temperature by a thermal shutdown active @ 150 °C.
4. Exceeding the power derating curves over a long period causes abnormal operation.
5. Human body model: 100 pF discharged through a 1.5 k $\Omega$  resistor between two pins of the device, done for all couples of pin combinations with other pins floating.
6. Machine model: a 200 pF cap is charged to the specified voltage, then discharged directly between two pins of the device with no external series resistor (internal resistor < 5  $\Omega$ ), done for all couples of pin combinations with other pins floating.

Table 2. Operating conditions

Symbol	Parameter	Value	Unit
V <sub>CC</sub>	Supply voltage	2.5 to 5.5	V
V <sub>I</sub>	Input voltage range	GND to V <sub>CC</sub>	
V <sub>ic</sub>	Input common mode voltage <sup>(1)</sup>	GND+0.5V to V <sub>CC</sub> -0.9V	
V <sub>STBY</sub>	Standby voltage input <sup>(2)</sup> Device ON Device in STANDBY <sup>(3)</sup>	1.4 ≤ V <sub>STBY</sub> ≤ V <sub>CC</sub> GND ≤ V <sub>STBY</sub> ≤ 0.4	
R <sub>L</sub>	Load resistor	≥ 4	Ω
V <sub>IH</sub>	G0, G1 - high level input voltage <sup>(4)</sup>	1.4 ≤ V <sub>IH</sub> ≤ V <sub>CC</sub>	V
V <sub>IL</sub>	G0, G1 - low level input voltage	GND ≤ V <sub>IL</sub> ≤ 0.4	
R <sub>thja</sub>	Thermal resistance junction to ambient <sup>(5)</sup>	40	°C/W

1. |V<sub>oo</sub>| ≤ 40 mV max with all differential gains except 24 dB. For 24 dB gain, input decoupling caps are mandatory.
2. Without any signal on V<sub>STBY</sub>, the device is in standby (internal 300 kΩ ± 20 % pull-down resistor).
3. Minimum current consumption is obtained when V<sub>STBY</sub> = GND.
4. Between G0, G1 pins and GND, there is an internal 300kΩ (±20 %) pull-down resistor. When pins are floating, the gain is 6 dB. In full standby (left and right channels OFF), these resistors are disconnected (HiZ input).
5. With 4-layer PCB.

## 2 Typical application

Figure 1. Typical application schematics

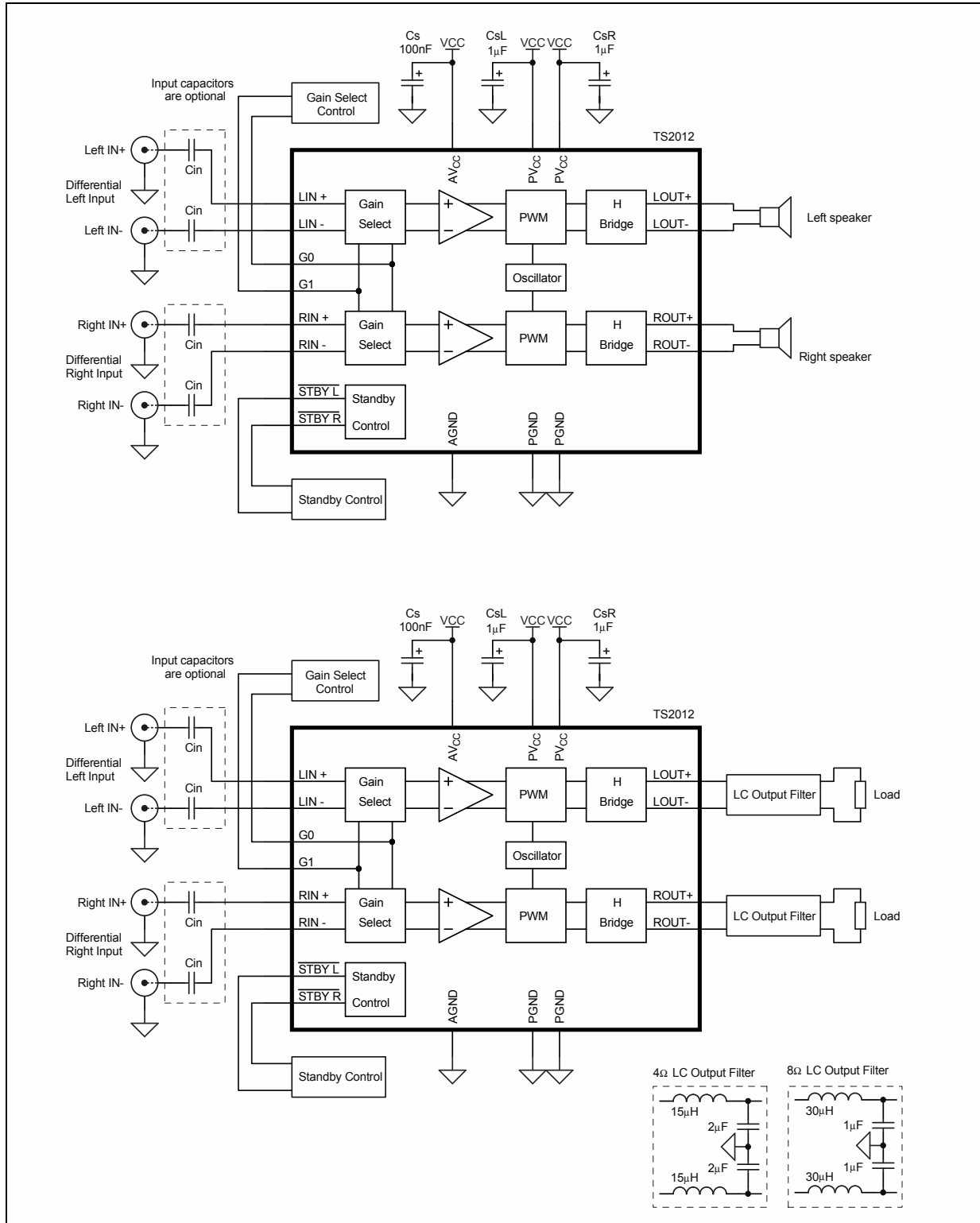

**Table 3. External component descriptions**

Components	Functional description
C <sub>S</sub> , C <sub>SL</sub> , C <sub>SR</sub>	Supply capacitor that provides power supply filtering.
C <sub>in</sub>	Input coupling capacitors (optional) that block the DC voltage at the amplifier input terminal. The capacitors also form a high pass filter with Z <sub>in</sub> ( $F_{cl} = 1 / (2 \times \pi \times Z_{in} \times C_{in})$ ).

**Table 4. Pin descriptions**

Pin number	Pin name	Pin description
1	G1	Gain select pin (MSB)
2	Lout+	Left channel positive output
3	PVCC	Power supply
4	PGND	Power ground
5	Lout-	Left channel negative output
6	NC	No internal connection
7	STBYL	Standby pin (active low) for left channel output
8	STBYR	Standby pin (active low) for right channel output
9	AVCC	Analog supply
10	NC	No internal connection
11	Rout-	Right channel negative output
12	PGND	Power ground
13	PVCC	Power supply
14	Rout+	Right channel positive output
15	G0	Gain select pin (LSB)
16	Rin+	Right channel positive differential input
17	Rin-	Right channel negative differential input
18	AGND	Analog ground
19	Lin-	Left channel negative differential input
20	Lin+	Left channel positive differential input
	Thermal pad	Connect the thermal pad of the QFN package to PCB ground

### 3 Electrical characteristics

#### 3.1 Electrical characteristic tables

Table 5.  $V_{CC} = +5\text{ V}$ ,  $GND = 0\text{ V}$ ,  $V_{IC} = 2.5\text{ V}$ ,  $T_{amb} = 25\text{ }^{\circ}\text{C}$   
(unless otherwise specified)

Symbol	Parameters and test conditions	Min.	Typ.	Max.	Unit
$I_{CC}$	Supply current No input signal, no load, both channels		5	8	mA
$I_{STBY}$	Standby current No input signal, $V_{STBY} = GND$		0.2	2	$\mu\text{A}$
$V_{oo}$	Output offset voltage Floating inputs, $G = 6\text{ dB}$ , $R_L = 8\ \Omega$			25	mV
$P_o$	Output power THD + N = 1 % max, $f = 1\text{ kHz}$ , $R_L = 4\ \Omega$ THD + N = 1 % max, $f = 1\text{ kHz}$ , $R_L = 8\ \Omega$ THD + N = 10 % max, $f = 1\text{ kHz}$ , $R_L = 4\ \Omega$ THD + N = 10 % max, $f = 1\text{ kHz}$ , $R_L = 8\ \Omega$		2.2 1.35 2.8 1.65		W
THD + N	Total harmonic distortion + noise $P_o = 0.8\text{ W}$ , $G = 6\text{ dB}$ , $f = 1\text{ kHz}$ , $R_L = 8\ \Omega$		0.07		%
Efficiency	Efficiency per channel $P_o = 2.2\text{ W}$ , $R_L = 4\ \Omega + 15\ \mu\text{H}$ $P_o = 1.25\text{ W}$ , $R_L = 8\ \Omega + 15\ \mu\text{H}$		81 89		
PSRR	Power supply rejection ratio with inputs grounded $C_{in} = 1\ \mu\text{F}$ <sup>(1)</sup> , $f = 217\text{ Hz}$ , $R_L = 8\ \Omega$ , Gain = 6 dB, $V_{ripple} = 200\text{ mV}_{pp}$		70		dB
Crosstalk	Channel separation $P_o = 0.9\text{ W}$ , $G = 6\text{ dB}$ , $f = 1\text{ kHz}$ , $R_L = 8\ \Omega$		90		
CMRR	Common mode rejection ratio $C_{in} = 1\ \mu\text{F}$ , $f = 217\text{ Hz}$ , $R_L = 8\ \Omega$ , Gain = 6 dB, $\Delta V_{ICM} = 200\text{ mV}_{pp}$		70		
Gain	Gain value $G1 = G0 = V_{IL}$ $G1 = V_{IL}$ & $G0 = V_{IH}$ $G1 = V_{IH}$ & $G0 = V_{IL}$ $G1 = G0 = V_{IH}$	5.5 11.5 17.5 23.5	6 12 18 24	6.5 12.5 18.5 24.5	
$Z_{in}$	Single ended input impedance All gains, referred to ground	24	30	36	k $\Omega$
$F_{PWM}$	Pulse width modulator base frequency	190	280	370	kHz
SNR	Signal to noise ratio (A-weighting) $P_o = 1.3\text{ W}$ , $G = 6\text{ dB}$ , $R_L = 8\ \Omega$		99		dB
$t_{WU}$	Wakeup time		1	3	ms
$t_{STBY}$	Standby time		1		

**Table 5.  $V_{CC} = +5\text{ V}$ ,  $GND = 0\text{ V}$ ,  $V_{ic} = 2.5\text{ V}$ ,  $T_{amb} = 25\text{ °C}$   
(unless otherwise specified) (continued)**

Symbol	Parameters and test conditions	Min.	Typ.	Max.	Unit
$V_N$	Output voltage noise $f = 20\text{ Hz to } 20\text{ kHz}$ , $R_L = 8\ \Omega$				$\mu\text{V}_{RMS}$
	Unweighted (filterless, $G = 6\text{ dB}$ )		63		
	A-weighted (filterless, $G = 6\text{ dB}$ )		35		
	Unweighted (with LC output filter, $G = 6\text{ dB}$ )		60		
	A-weighted (with LC output filter, $G = 6\text{ dB}$ )		35		
	Unweighted (filterless, $G = 24\text{ dB}$ )		115		
	A-weighted (filterless, $G = 24\text{ dB}$ )		72		
	Unweighted (with LC output filter, $G = 24\text{ dB}$ )		109		
A-weighted (with LC output filter, $G = 24\text{ dB}$ )		71			

1. Dynamic measurements -  $20 \cdot \log(\text{rms}(V_{out})/\text{rms}(V_{ripple}))$ .  $V_{ripple}$  is the superimposed sinus signal to  $V_{CC}$  @  $f = 217\text{ Hz}$ .



**Table 6.  $V_{CC} = +3.6\text{ V}$ ,  $GND = 0\text{ V}$ ,  $V_{IC} = 1.8\text{ V}$ ,  $T_{amb} = 25\text{ °C}$   
(unless otherwise specified)**

Symbol	Parameter	Min.	Typ.	Max.	Unit
$I_{CC}$	Supply current No input signal, no load, both channels		3.3	6.5	mA
$I_{STBY}$	Standby current No input signal, $V_{STBY} = GND$		0.2	2	$\mu\text{A}$
$V_{oo}$	Output offset voltage Floating inputs, $G = 6\text{ dB}$ , $R_L = 8\ \Omega$			25	mV
$P_o$	Output power THD + N = 1 % max, $f = 1\text{ kHz}$ , $R_L = 4\ \Omega$ THD + N = 1 % max, $f = 1\text{ kHz}$ , $R_L = 8\ \Omega$ THD + N = 10 % max, $f = 1\text{ kHz}$ , $R_L = 4\ \Omega$ THD + N = 10 % max, $f = 1\text{ kHz}$ , $R_L = 8\ \Omega$		1.15 0.68 1.3 0.9		W
THD + N	Total harmonic distortion + noise $P_o = 0.4\text{ W}$ , $G = 6\text{ dB}$ , $f = 1\text{ kHz}$ , $R_L = 8\ \Omega$		0.05		%
Efficiency	Efficiency per channel $P_o = 1.15\text{ W}$ , $R_L = 4\ \Omega + 15\ \mu\text{H}$ $P_o = 0.68\text{ W}$ , $R_L = 8\ \Omega + 15\ \mu\text{H}$		80 88		
PSRR	Power supply rejection ratio with inputs grounded $C_{in} = 1\ \mu\text{F}$ <sup>(1)</sup> , $f = 217\text{ Hz}$ , $R_L = 8\ \Omega$ , Gain = 6 dB, $V_{ripple} = 200\text{ mV}_{pp}$		70		dB
Crosstalk	Channel separation $P_o = 0.5\text{ W}$ , $G = 6\text{ dB}$ , $f = 1\text{ kHz}$ , $R_L = 8\ \Omega$		90		
CMRR	Common mode rejection ratio $C_{in} = 1\ \mu\text{F}$ , $f = 217\text{ Hz}$ , $R_L = 8\ \Omega$ , Gain = 6 dB, $\Delta V_{ICM} = 200\text{ mV}_{pp}$		70		
Gain	Gain value $G1 = G0 = V_{IL}$ $G1 = V_{IL}$ & $G0 = V_{IH}$ $G1 = V_{IH}$ & $G0 = V_{IL}$ $G1 = G0 = V_{IH}$	5.5 11.5 17.5 23.5	6 12 18 24	6.5 12.5 18.5 24.5	
$Z_{in}$	Single ended input impedance All gains, referred to ground	24	30	36	k $\Omega$
$F_{PWM}$	Pulse width modulator base frequency	190	280	370	kHz
SNR	Signal to noise ratio (A-weighting) $P_o = 0.65\text{ W}$ , $G = 6\text{ dB}$ , $R_L = 8\ \Omega$		96		dB
$t_{WU}$	Wakeup time		1	3	ms
$t_{STBY}$	Standby time		1		

**Table 6.  $V_{CC} = +3.6\text{ V}$ ,  $GND = 0\text{ V}$ ,  $V_{ic} = 1.8\text{ V}$ ,  $T_{amb} = 25\text{ }^\circ\text{C}$   
(unless otherwise specified) (continued)**

Symbol	Parameter	Min.	Typ.	Max.	Unit
$V_N$	Output voltage noise $f = 20\text{ Hz to } 20\text{ kHz}$ , $R_L = 4\ \Omega$				$\mu\text{V}_{RMS}$
	Unweighted (filterless, $G = 6\text{ dB}$ )		58		
	A-weighted (filterless, $G = 6\text{ dB}$ )		34		
	Unweighted (with LC output filter, $G = 6\text{ dB}$ )		55		
	A-weighted (with LC output filter, $G = 6\text{ dB}$ )		34		
	Unweighted (filterless, $G = 24\text{ dB}$ )		111		
	A-weighted (filterless, $G = 24\text{ dB}$ )		70		
	Unweighted (with LC output filter, $G = 24\text{ dB}$ )		105		
A-weighted (with LC output filter, $G = 24\text{ dB}$ )		69			

1. Dynamic measurements -  $20 \cdot \log(\text{rms}(V_{out})/\text{rms}(V_{ripple}))$ .  $V_{ripple}$  is the superimposed sinus signal to  $V_{CC}$  @  $f = 217\text{ Hz}$ .

**Table 7.  $V_{CC} = +2.5V$ ,  $GND = 0V$ ,  $V_{ic}=1.25V$ ,  $T_{amb} = 25^{\circ}C$   
(unless otherwise specified)**

Symbol	Parameter	Min.	Typ.	Max.	Unit
$I_{CC}$	Supply current No input signal, no load, both channels		2.8	4	mA
$I_{STBY}$	Standby current No input signal, $V_{STBY} = GND$		0.2	2	$\mu A$
$V_{oo}$	Output offset voltage Floating inputs, $G = 6dB$ , $R_L = 8\Omega$			25	mV
$P_o$	Output power THD + N = 1 % max, $f = 1$ kHz, $R_L = 4 \Omega$ THD + N = 1 % max, $f = 1$ kHz, $R_L = 8 \Omega$ THD + N = 10 % max, $f = 1$ kHz, $R_L = 4 \Omega$ THD + N = 10 % max, $f = 1$ kHz, $R_L = 8 \Omega$		0.53 0.32 0.75 0.45		W
THD + N	Total harmonic distortion + noise $P_o = 0.2$ W, $G = 6$ dB, $f = 1$ kHz, $R_L = 8 \Omega$		0.04		%
Efficiency	Efficiency per channel $P_o = 0.53$ W, $R_L = 4 \Omega + 15 \mu H$ $P_o = 0.32$ W, $R_L = 8 \Omega + 15 \mu H$		80 88		
PSRR	Power supply rejection ratio with inputs grounded $C_{in} = 1 \mu F$ <sup>(1)</sup> , $f = 217$ Hz, $R_L = 8 \Omega$ , Gain = 6 dB, $V_{ripple} = 200$ mV <sub>pp</sub>		70		dB
Crosstalk	Channel separation $P_o = 0.2$ W, $G = 6$ dB, $f = 1$ kHz, $R_L = 8 \Omega$		90		
CMRR	Common mode rejection ratio $C_{in} = 1 \mu F$ , $f = 217$ Hz, $R_L = 8 \Omega$ , Gain = 6 dB, $\Delta V_{ICM} = 200$ mV <sub>pp</sub>		70		
Gain	Gain value $G1 = G0 = V_{IL}$ $G1 = V_{IL} \ \& \ G0 = V_{IH}$ $G1 = V_{IH} \ \& \ G0 = V_{IL}$ $G1 = G0 = V_{IH}$	5.5 11.5 17.5 23.5	6 12 18 24	6.5 12.5 18.5 24.5	
$Z_{in}$	Single ended input impedance All gains, referred to ground	24	30	36	k $\Omega$
$F_{PWM}$	Pulse width modulator base frequency	190	280	370	kHz
SNR	Signal to noise ratio (A-weighting) $P_o = 0.3$ W, $G = 6$ dB, $R_L = 8 \Omega$		93		dB
$t_{WU}$	Wakeup time		1	3	ms
$t_{STBY}$	Standby time		1		

Table 7.  $V_{CC} = +2.5V$ ,  $GND = 0V$ ,  $V_{ic}=1.25V$ ,  $T_{amb} = 25^{\circ}C$   
(unless otherwise specified) (continued)

Symbol	Parameter	Min.	Typ.	Max.	Unit
$V_N$	Output voltage noise $f = 20\text{ Hz to } 20\text{ kHz}$ , $R_L = 8\ \Omega$				
	Unweighted (filterless, $G = 6\text{ dB}$ )		57		$\mu V_{RMS}$
	A-weighted (filterless, $G = 6\text{ dB}$ )		34		
	Unweighted (with LC output filter, $G = 6\text{ dB}$ )		54		
	A-weighted (with LC output filter, $G = 6\text{ dB}$ )		33		
	Unweighted (filterless, $G = 24\text{ dB}$ )		110		
	A-weighted (filterless, $G = 24\text{ dB}$ )		71		
	Unweighted (with LC output filter, $G = 24\text{ dB}$ )		104		
A-weighted (with LC output filter, $G = 24\text{ dB}$ )		69			

1. Dynamic measurements -  $20 \cdot \log(\text{rms}(V_{out})/\text{rms}(V_{ripple}))$ .  $V_{ripple}$  is the superimposed sinus signal to  $V_{CC}$  @  $f = 217\text{ Hz}$ .

### 3.2 Electrical characteristic curves

The graphs shown in this section use the following abbreviations:

- $R_L + 15\ \mu H$  or  $30\ \mu H$  = pure resistor + very low series resistance inductor
- Filter = LC output filter ( $1\ \mu F + 30\ \mu H$  for  $4\ \Omega$  and  $0.5\ \mu F + 60\ \mu H$  for  $8\ \Omega$ )

All measurements are made with  $C_{SL} = C_{SR} = 1\ \mu F$  and  $C_S = 100\text{ nF}$  (see [Figure 2](#)), except for the PSRR where  $C_{SL,R}$  is removed (see [Figure 3](#)).

Figure 2. Test diagram for measurements

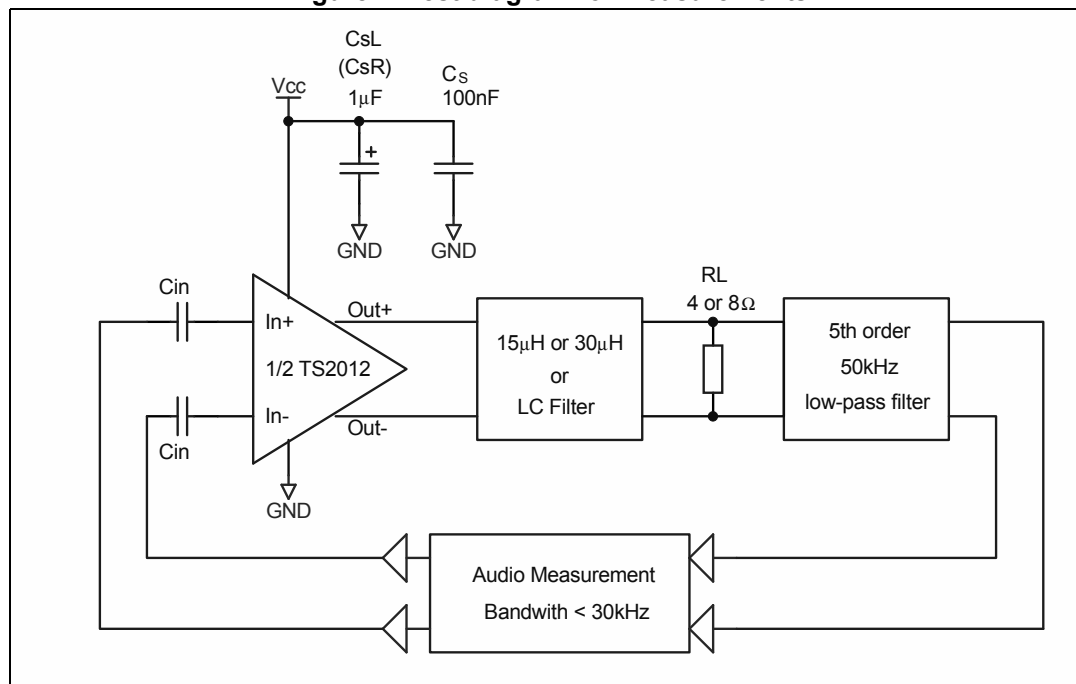

Figure 3. Test diagram for PSRR measurements

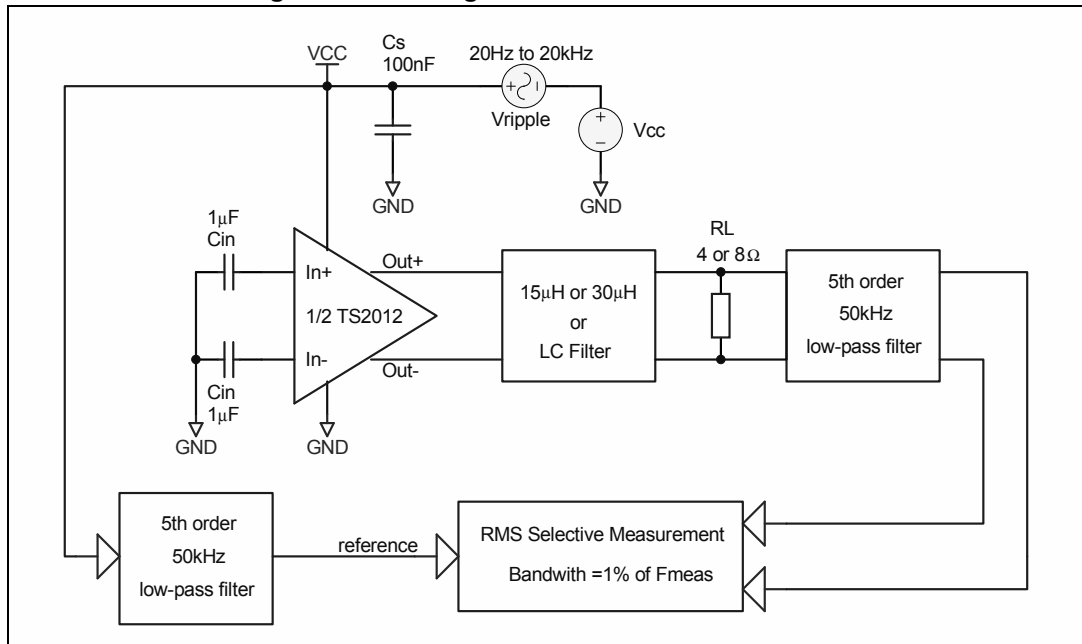

Table 8. Index of graphics

Description	Figure
Current consumption vs. power supply voltage	<a href="#">Figure 4</a>
Current consumption vs. standby voltage	<a href="#">Figure 5</a>
Efficiency vs. output power	<a href="#">Figure 6 - Figure 9</a>
Output power vs. power supply voltage	<a href="#">Figure 10, Figure 11</a>
PSRR vs. common mode input voltage	<a href="#">Figure 12</a>
PSRR vs. frequency	<a href="#">Figure 13</a>
CMRR vs. common mode input voltage	<a href="#">Figure 14</a>
CMRR vs. frequency	<a href="#">Figure 15</a>
Gain vs. frequency	<a href="#">Figure 16, Figure 17</a>
THD+N vs. output power	<a href="#">Figure 18 - Figure 25</a>
THD+N vs. frequency	<a href="#">Figure 26 - Figure 37</a>
Crosstalk vs. frequency	<a href="#">Figure 38 - Figure 41</a>
Power derating curves	<a href="#">Figure 42</a>
Startup and shutdown time	<a href="#">Figure 43, Figure 44</a>

Figure 4. Current consumption vs. power supply voltage

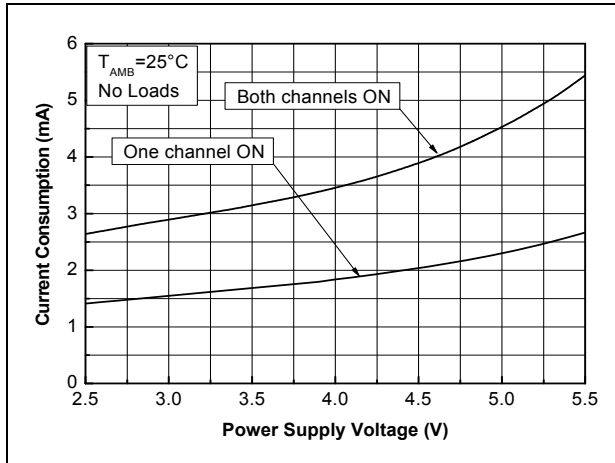

Figure 5. Current consumption vs. standby voltage (one channel)

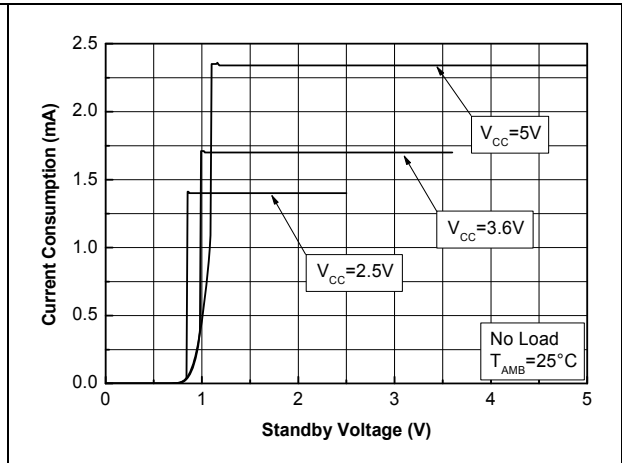

Figure 6. Efficiency vs. output power (i)

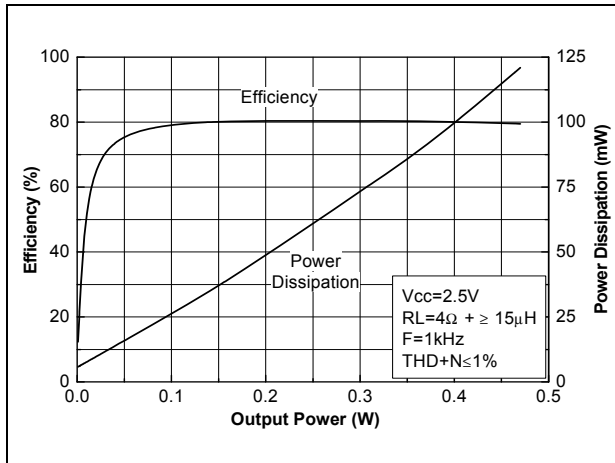

Figure 7. Efficiency vs. output power (ii)

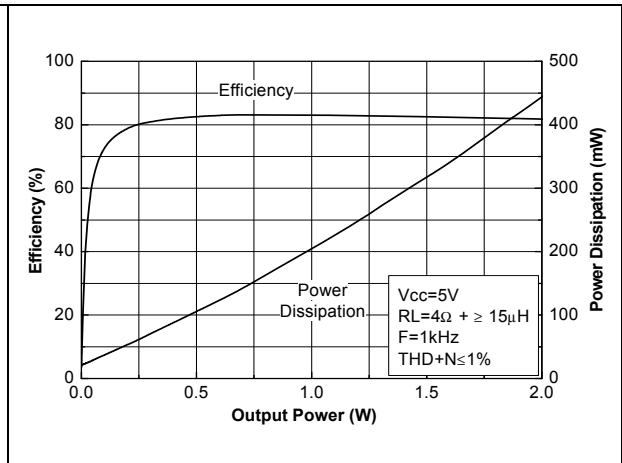

Figure 8. Efficiency vs. output power (iii)

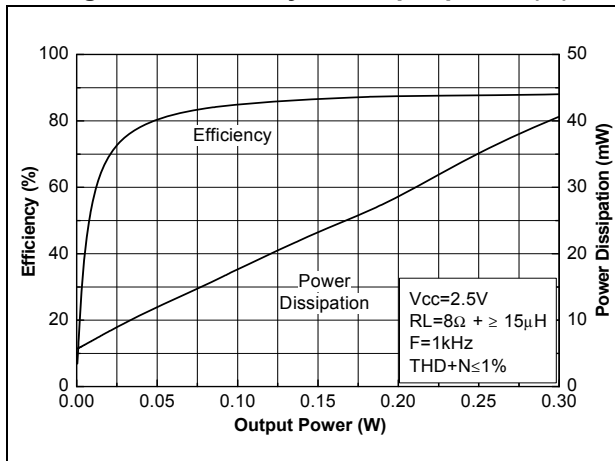

Figure 9. Efficiency vs. output power (iv)

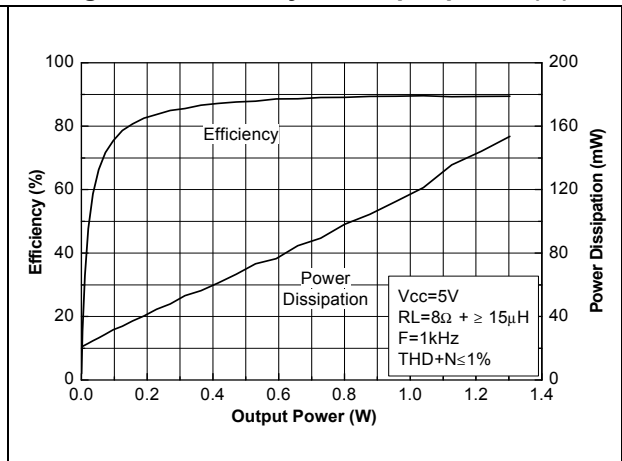

Figure 10. Output power vs. power supply voltage (i)

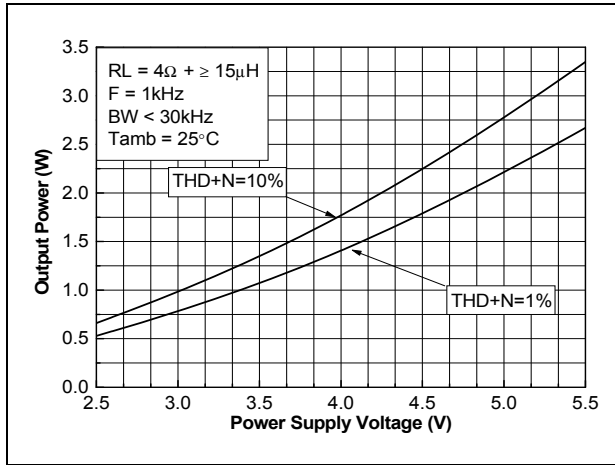

Figure 11. Output power vs. power supply voltage (ii)

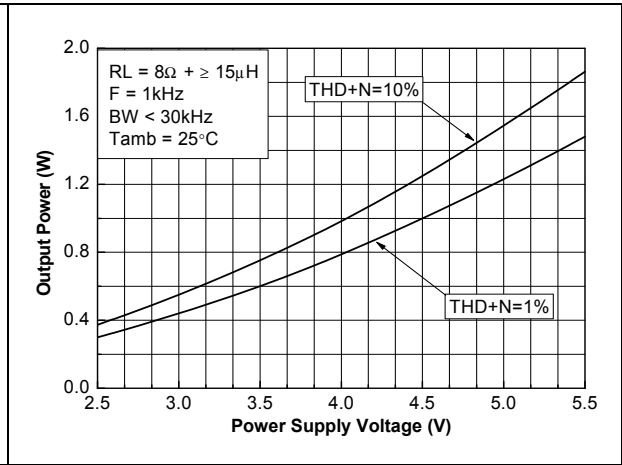

Figure 12. PSRR vs. common mode input voltage

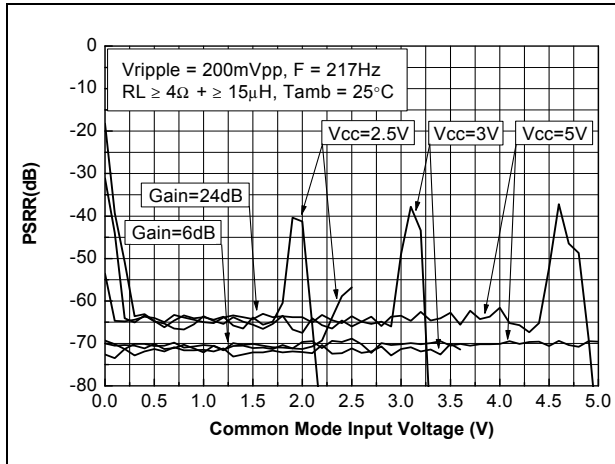

Figure 13. PSRR vs. frequency

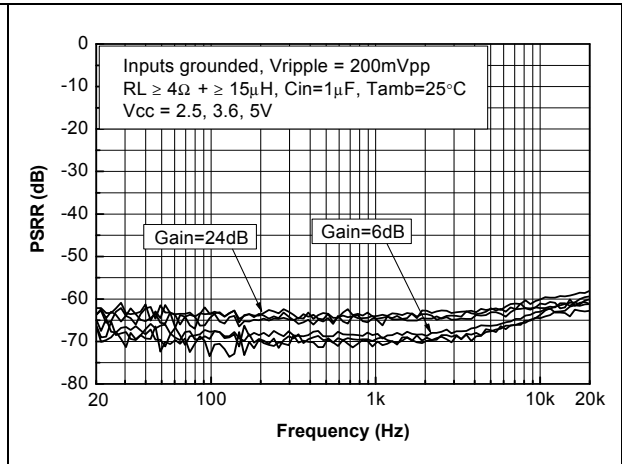

Figure 14. CMRR vs. common mode input voltage

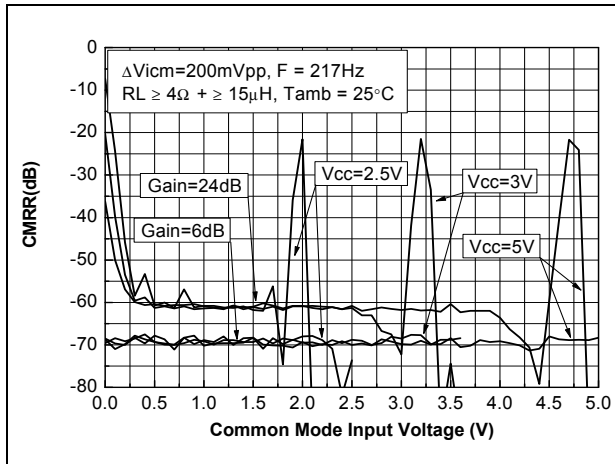

Figure 15. CMRR vs. frequency

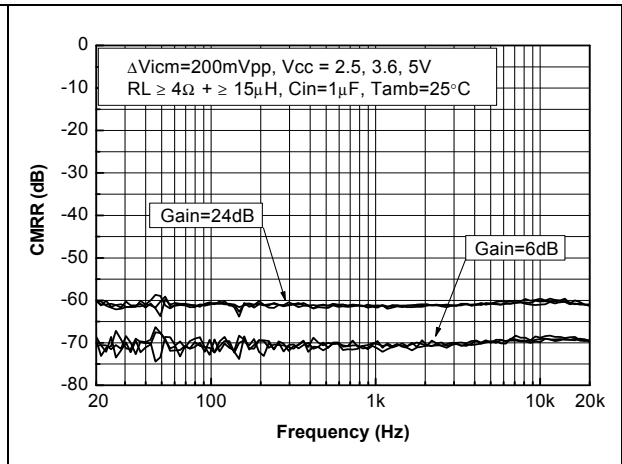

Figure 16. Gain vs. frequency (i)

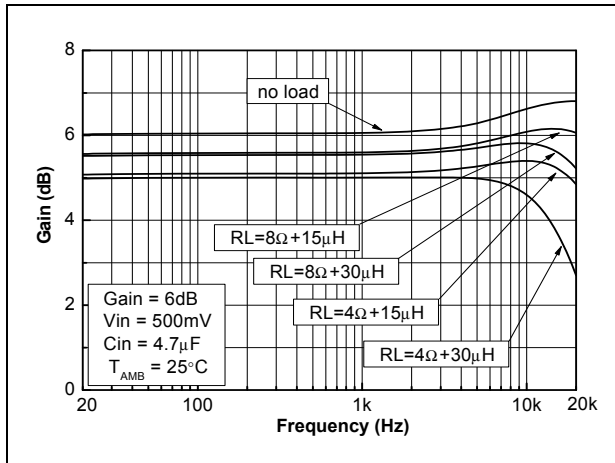

Figure 17. Gain vs. frequency (ii)

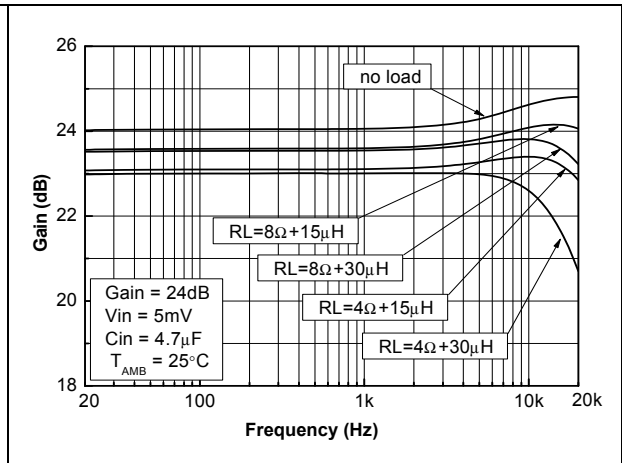

Figure 18. THD+N vs. output power (i)

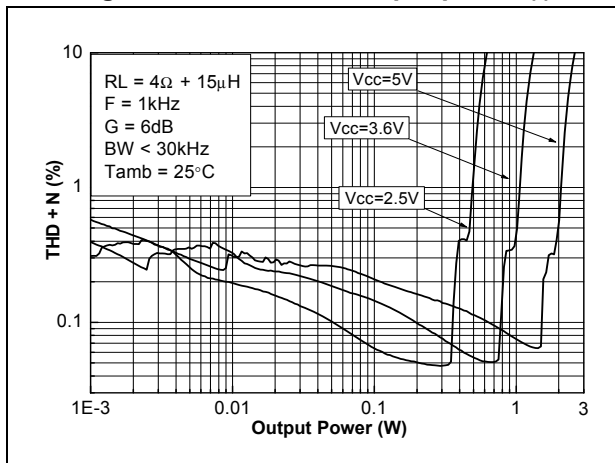

Figure 19. THD+N vs. output power (ii)

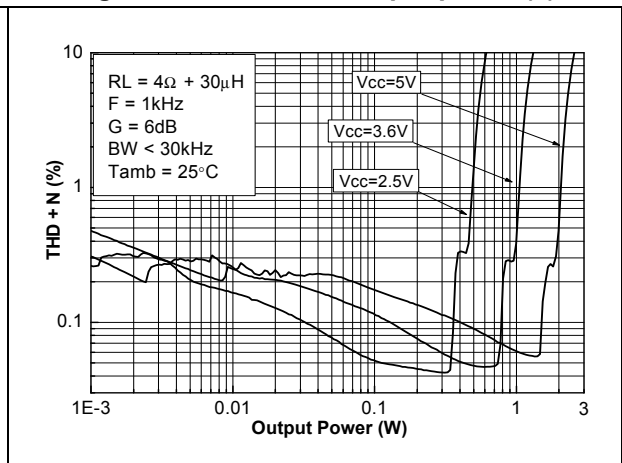

Figure 20. THD+N vs. output power (iii)

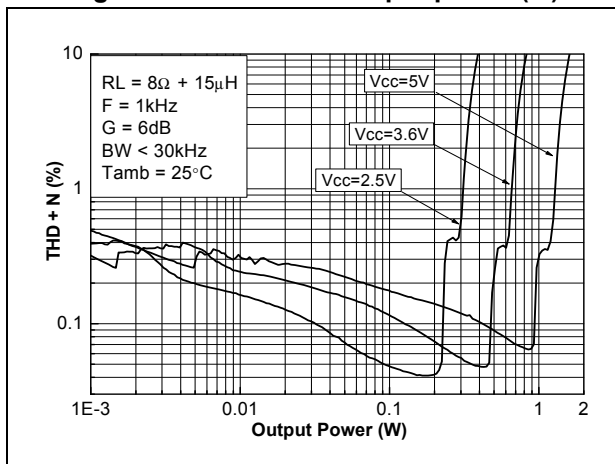

Figure 21. THD+N vs. output power (iv)

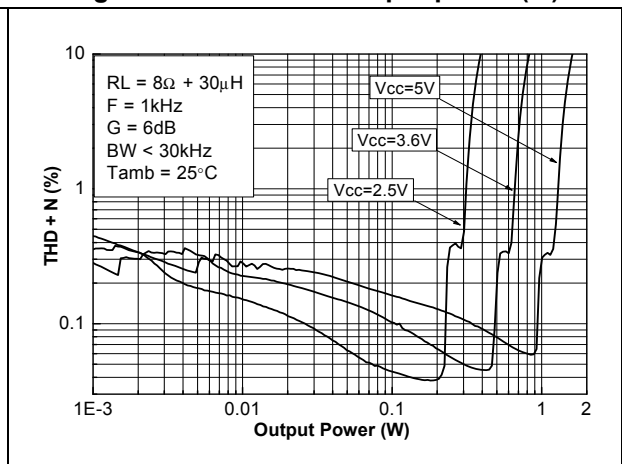



Figure 22. THD+N vs. output power (v)

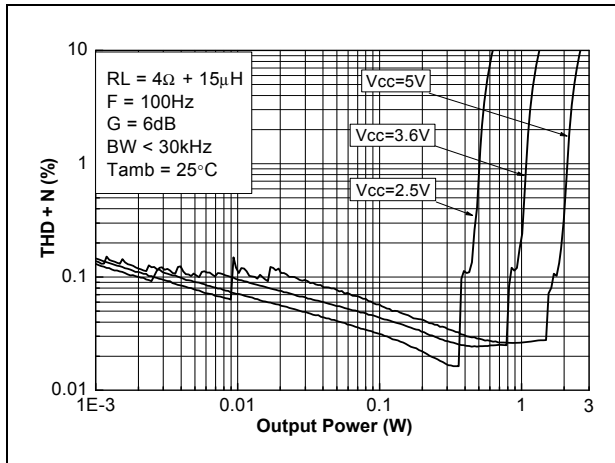

Figure 23. THD+N vs. output power (vi)

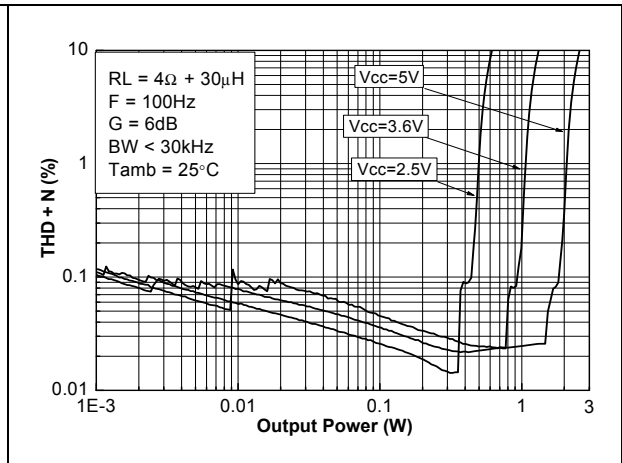

Figure 24. THD+N vs. output power (vii)

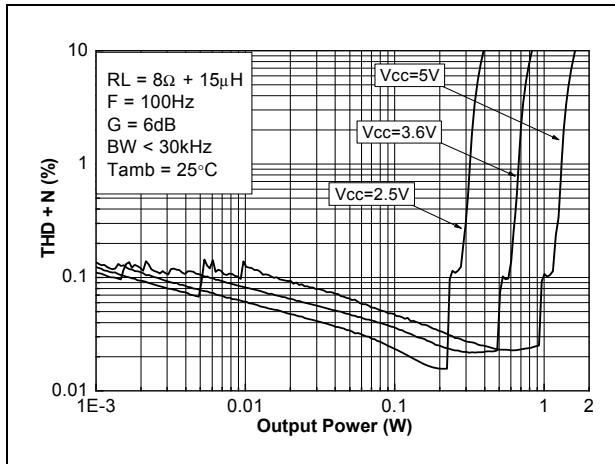

Figure 25. THD+N vs. output power (viii)

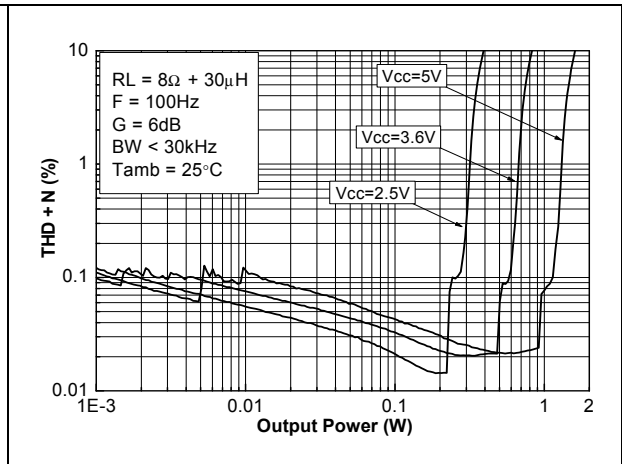

Figure 26. THD+N vs. frequency (i)

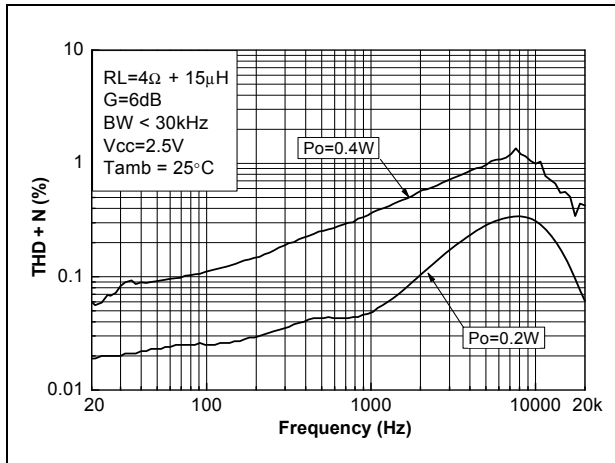

Figure 27. THD+N vs. frequency (ii)

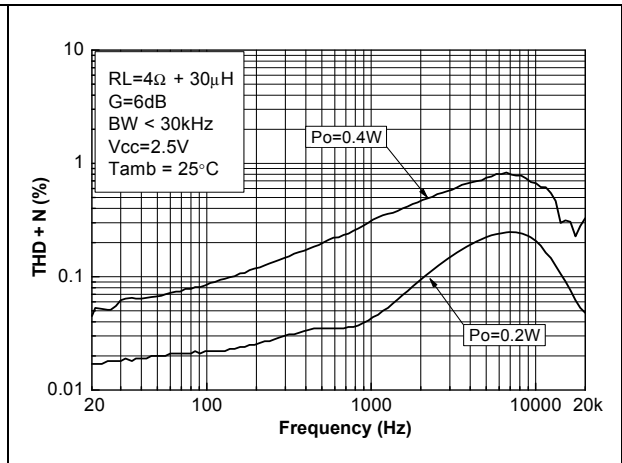

Figure 28. THD+N vs. frequency (iii)

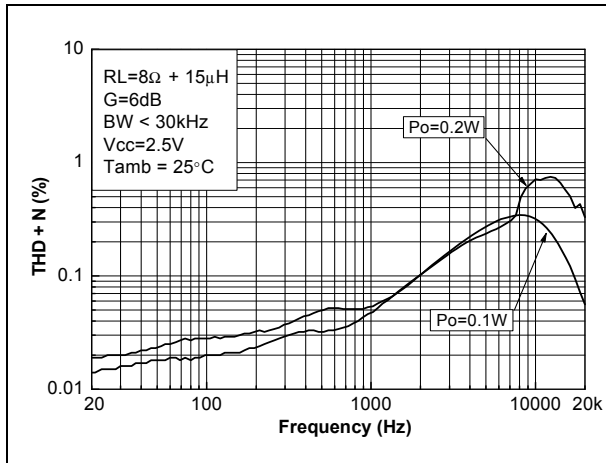

Figure 29. THD+N vs. frequency (iv)

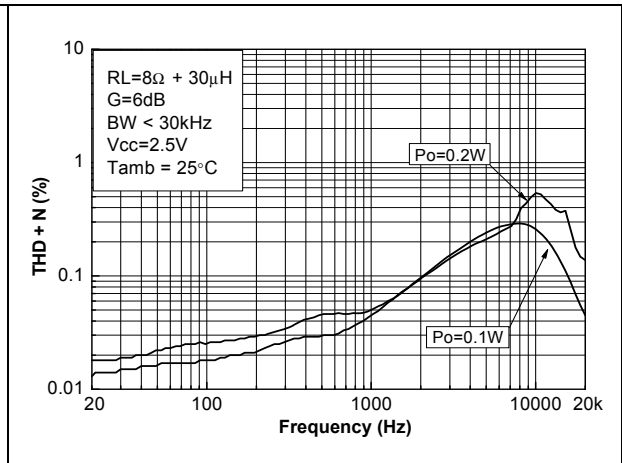

Figure 30. THD+N vs. frequency (v)

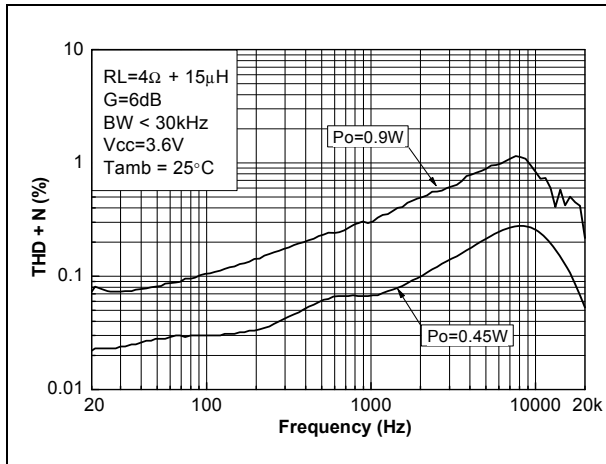

Figure 31. THD+N vs. frequency (vi)

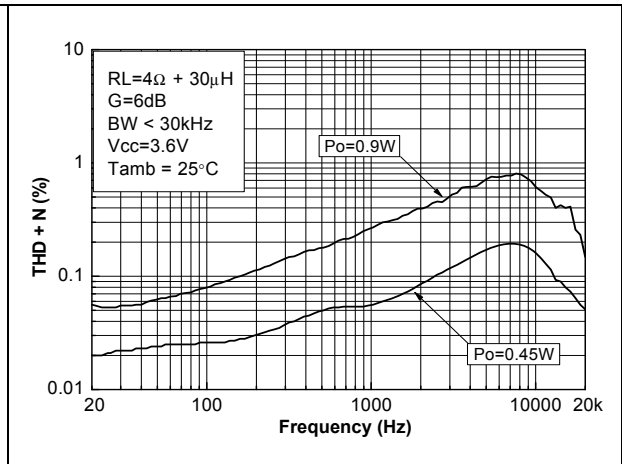

Figure 32. THD+N vs. frequency (vii)

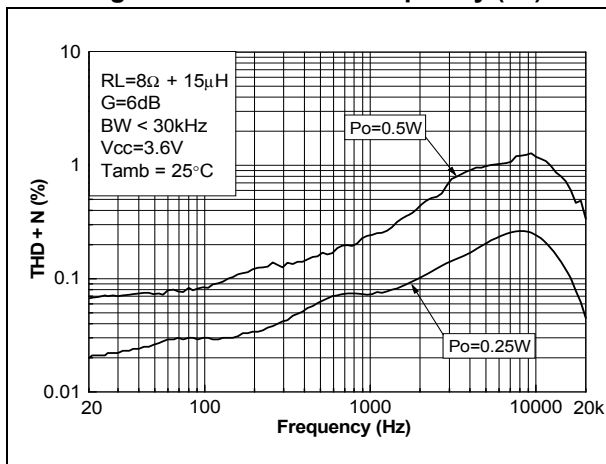

Figure 33. THD+N vs. frequency (viii)

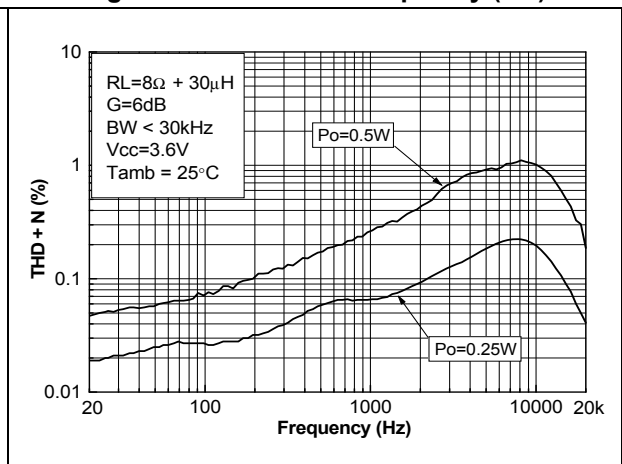

Figure 34. THD+N vs. frequency (ix)

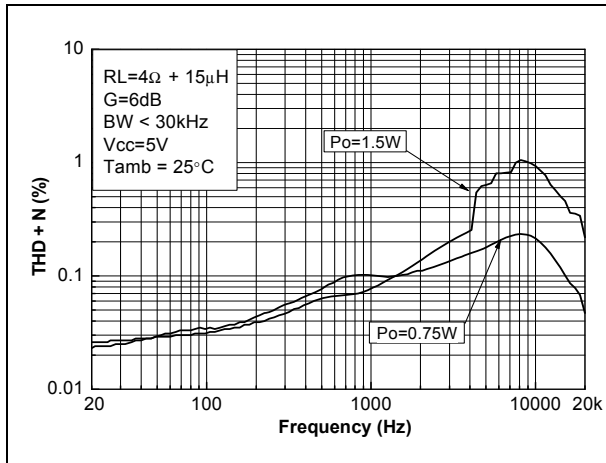

Figure 35. THD+N vs. frequency (x)

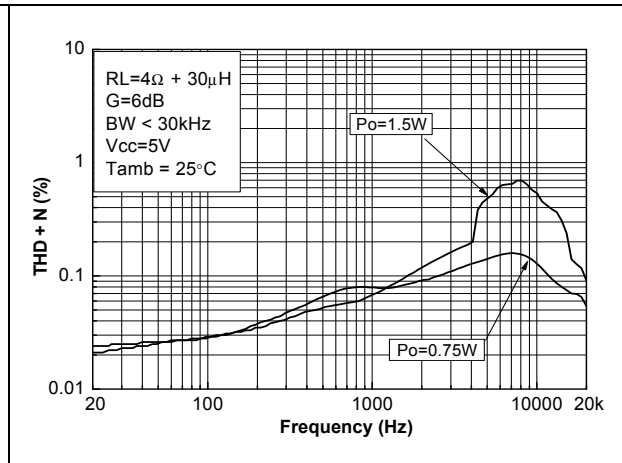

Figure 36. THD+N vs. frequency (xi)

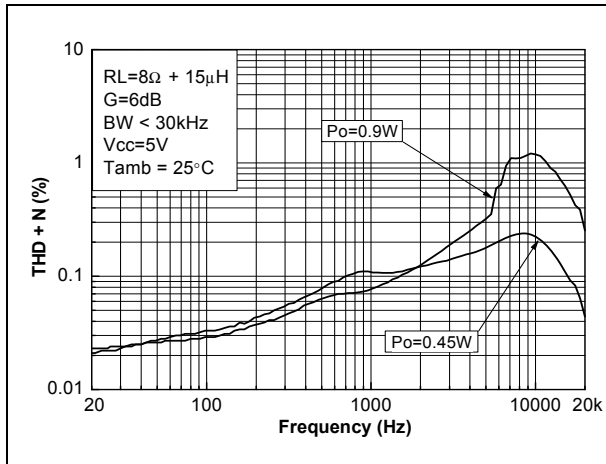

Figure 37. THD+N vs. frequency (xii)

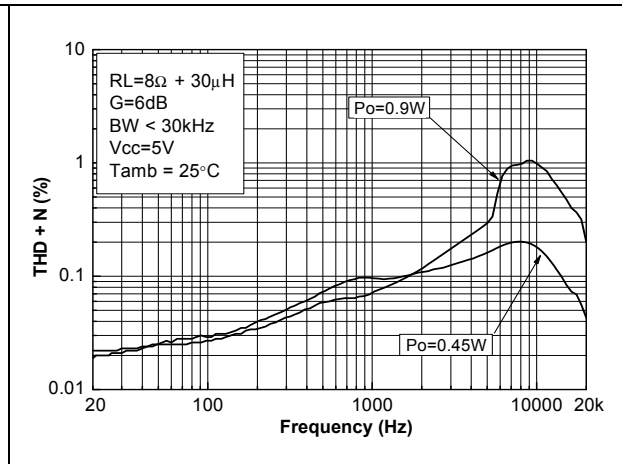

Figure 38. Crosstalk vs. frequency (i)

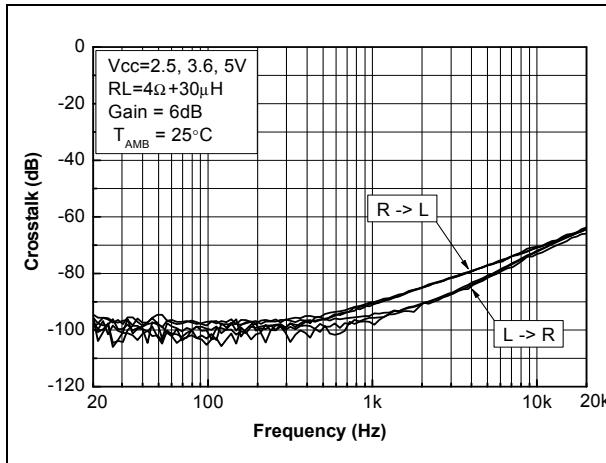

Figure 39. Crosstalk vs. frequency (ii)

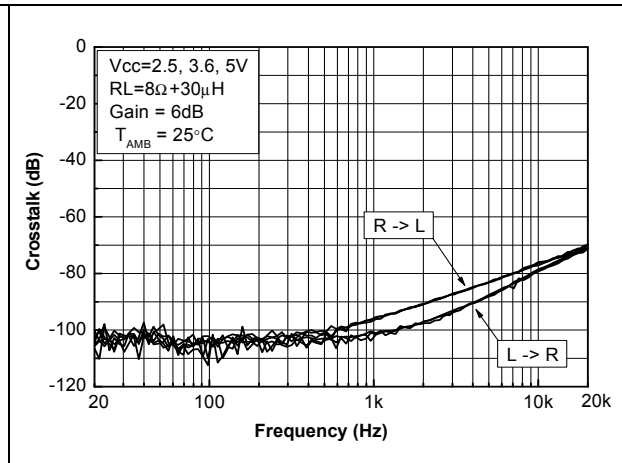

Figure 40. Crosstalk vs. frequency (iii)

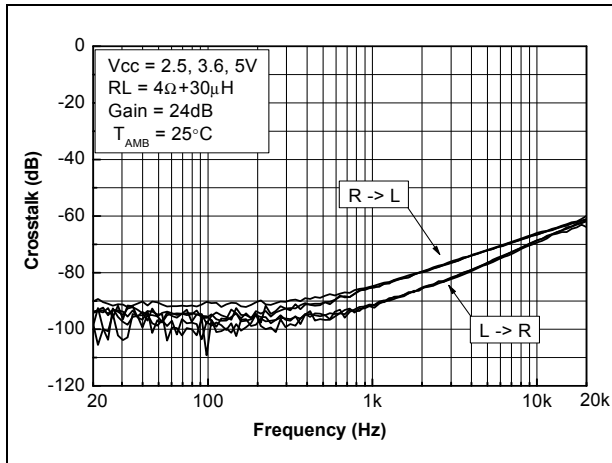

Figure 41. Crosstalk vs. frequency (iv)

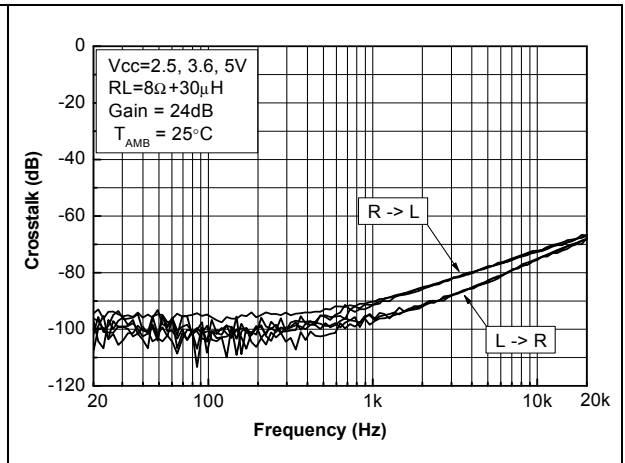

Figure 42. Power derating curves

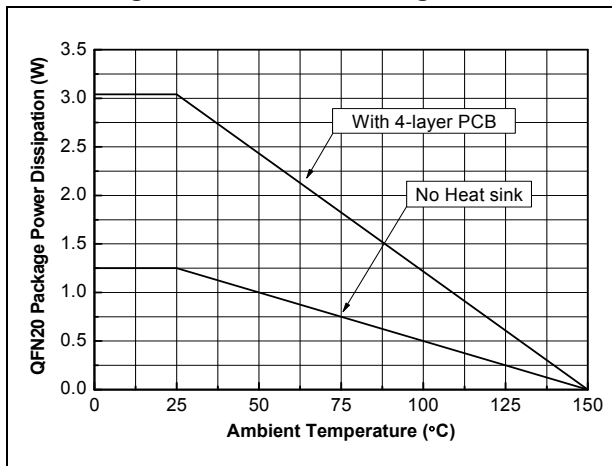

Figure 43. Startup and shutdown phase (i)

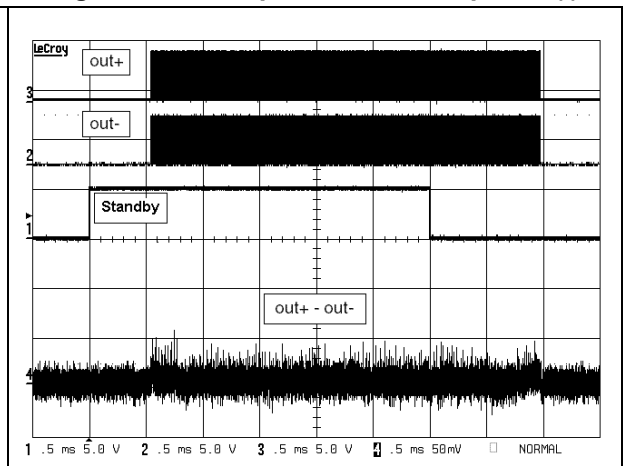
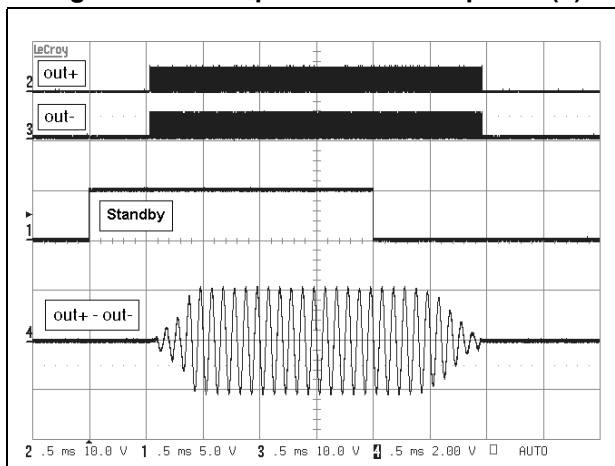

Figure 44. Startup and shutdown phase (ii)



## 4 Application information

### 4.1 Differential configuration principle

The TS2012 is a monolithic fully-differential input/output class D power amplifier. The TS2012 also includes a common-mode feedback loop that controls the output bias value to average it at  $V_{CC}/2$  for any DC common mode input voltage. This allows the device to always have a maximum output voltage swing, and by consequence, maximize the output power. Moreover, as the load is connected differentially compared with a single-ended topology, the output is four times higher for the same power supply voltage.

The **advantages** of a full-differential amplifier are:

- High PSRR (power supply rejection ratio)
- High common mode noise rejection
- Virtually zero pop without additional circuitry, giving a faster startup time compared with conventional single-ended input amplifiers
- Easier interfacing with differential output audio DAC
- No input coupling capacitors required thanks to common mode feedback loop

### 4.2 Gain settings

In the flat region of the frequency-response curve (no input coupling capacitor or internal feedback loop + load effect), the differential gain can be set to 6, 12, 18, or 24 dB depending on the logic level of the G0 and G1 pins, as shown in [Table 9](#).

**Table 9. Gain settings with G0 and G1 pins**

G1	G0	Gain (dB)	Gain (V/V)
0	0	6	2
0	1	12	4
1	0	18	8
1	1	24	16

*Note:* Between pins G0, G1 and GND there is an internal  $300\text{ k}\Omega(\pm 20\%)$  resistor. When the pins are floating, the gain is 6 dB. In full standby (left and right channels OFF), these resistors are disconnected (HiZ input).

### 4.3 Common mode feedback loop limitations

The common mode feedback loop allows the output DC bias voltage to be averaged at  $V_{CC}/2$  for any DC common mode bias input voltage.

Due to the  $V_{ic}$  limitation of the input stage (see [Table 2: Operating conditions](#)), the common mode feedback loop can fulfill its role only within the defined range.

## 4.4 Low frequency response

If a low frequency bandwidth limitation is required, it is possible to use input coupling capacitors. In the low frequency region, the input coupling capacitor,  $C_{in}$ , starts to have an effect.  $C_{in}$ , with the input impedance  $Z_{in}$ , forms a first order, high-pass filter with a -3 dB cut-off frequency (see [Table 5](#) to [Table 7](#)) as shown in [Equation 1](#):

### Equation 1

$$F_{CL} = \frac{1}{2 \cdot \pi \cdot Z_{in} \cdot C_{in}}$$

So, for a desired cut-off frequency,  $F_{CL}$ ,  $C_{in}$  is calculated as shown in [Equation 2](#):

### Equation 2

$$C_{in} = \frac{1}{2 \cdot \pi \cdot Z_{in} \cdot F_{CL}}$$

with  $F_{CL}$  in Hz,  $Z_{in}$  in  $\Omega$  and  $C_{in}$  in F.

The input impedance  $Z_{in}$  is typically 30 k $\Omega$  for the whole power supply voltage range. There is also a tolerance around the typical value (see [Table 5](#) to [Table 7](#)). The maximum and minimum tolerance of the  $F_{CL}$  can be calculated using [Equation 3](#) and [Equation 4](#) respectively.

### Equation 3

$$F_{CLmax} = 1.103 \cdot F_{CL}$$

### Equation 4

$$F_{CLmin} = 0.915 \cdot F_{CL}$$

## 4.5 Decoupling of the circuit

Power supply capacitors, referred to as  $C_S$ ,  $C_{SL}$ , and  $C_{SR}$  are needed to correctly bypass the TS2012.

The TS2012 has a typical switching frequency of 280 kHz and an output fall and rise time of about 5 ns. Due to these very fast transients, careful decoupling is mandatory.

A 1  $\mu$ F ceramic capacitor between each PVCC and PGND and also between AVCC and AGND is enough, but they must be located very close to the TS2012 in order to avoid any extra parasitic inductance created by a long track wire. Parasitic loop inductance, in relation to  $di/dt$ , introduces overvoltage that decreases the global efficiency of the device and may also cause a TS2012 breakdown if the parasitic inductance is too high.

In addition, even if a ceramic capacitor has an adequate high frequency ESR value, its current capability is also important. A 0603 size is a good compromise, particularly when a 4  $\Omega$  load is used.

Another important parameter is the rated voltage of the capacitor. A 1  $\mu\text{F}/6.3\text{ V}$  capacitor used at 5 V, loses about 50 % of its value. With a power supply voltage of 5 V, the decoupling value, instead of 1  $\mu\text{F}$ , could be reduced to 0.5  $\mu\text{F}$ . As  $C_S$  has particular influence on the THD+N in the medium to high frequency region, this capacitor variation becomes decisive. In addition, less decoupling means higher overshoots which can be problematic if they reach the power supply AMR value (6 V).

#### 4.6 Wakeup time ( $t_{wu}$ )

When standby is released to set the device ON, there is typically a delay of 1 ms. The TS2012 has an internal digital delay that mutes the outputs and releases them after this delay time to avoid any pop noise.

*Note:* The gain increases smoothly (see [Figure 44](#)) from the mute to the gain selected by the G1 and G0 pin ([Section 4.2](#)).

#### 4.7 Shutdown time

When the standby command is set, the time required to set the output stage to high impedance and to put the internal circuitry in shutdown mode, is typically 1 ms. This time is used to decrease the gain and avoid any pop noise during shutdown.

*Note:* The gain decreases smoothly until the outputs are muted (see [Figure 44](#)).

#### 4.8 Consumption in shutdown mode

Between the shutdown pin and GND there is an internal 300  $\text{k}\Omega$  ( $\pm 20\%$ ) resistor. This resistor forces the TS2012 to be in shutdown when the shutdown input is left floating.

However, this resistor also introduces additional shutdown power consumption if the shutdown pin voltage is not 0 V.

For example, with a 0.4 V shutdown voltage pin, the following typical and maximum values respectively for each shutdown pin must be added to the standby current specified in [Table 5](#) to [Table 7](#):  $0.4\text{ V}/300\text{ k}\Omega = 1.3\text{ }\mu\text{A}$  and  $0.4\text{ V}/240\text{ k}\Omega = 1.66\text{ }\mu\text{A}$ . This current is provided by the external control device for standby pins.

### 4.9 Single-ended input configuration

It is possible to use the TS2012 in a single-ended input configuration. However, input coupling capacitors are mandatory in this configuration. The schematic diagram in [Figure 45](#) shows a typical single-ended input application.

**Figure 45. Typical application for single-ended input configuration**

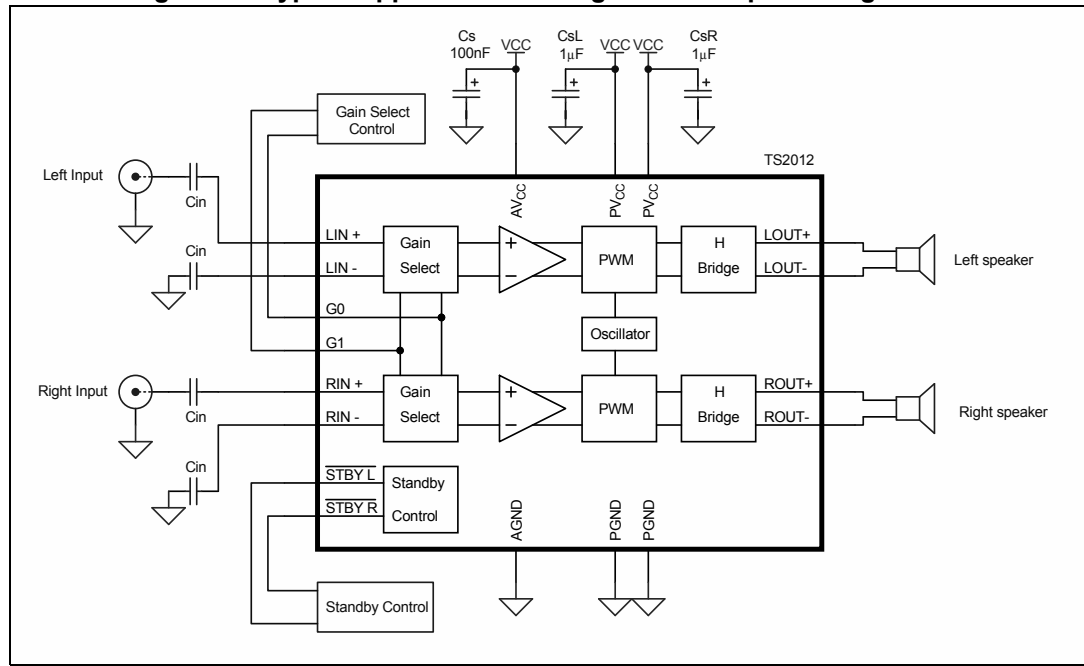

### 4.10 Output filter considerations

The TS2012 is designed to operate without an output filter. However, due to very sharp transients on the TS2012 output, EMI radiated emissions may cause some standard compliance issues.

These EMI standard compliance issues can appear if the distance between the TS2012 outputs and the loudspeaker terminal are long (typically more than 50 mm or 100 mm, in both directions, to the speaker terminals). As the PCB layout and internal equipment device are different for each configuration, it is difficult to provide a one-size-fits-all solution.

However, to decrease the probability of EMI issues, the following simple rules should be followed:

- Reduce as much as possible the distance between the TS2012 output pins and the speaker terminals.
- Use a ground plane for “shielding” sensitive wires.
- Place, as close as possible to the TS2012 and in series with each output, a ferrite bead with a minimum rated current of 2.5 A and an impedance greater than 50 Ω at frequencies above 30 MHz. If, after testing, these ferrite beads are not necessary, replace them by a short-circuit.
- Allow extra footprint to place, if necessary, a capacitor to short perturbations to ground (see [Figure 46](#)).

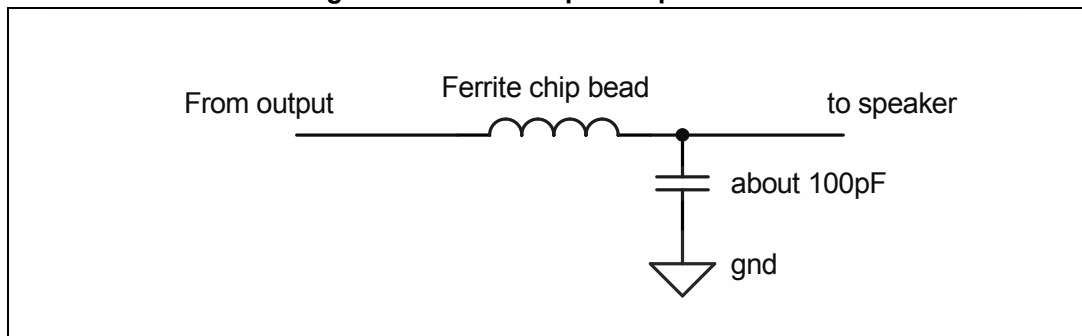

**Figure 46. Ferrite chip bead placement**

If the distance between the TS2012 output and the speaker terminals is too long, it is possible to have low frequency EMI issues due to the fact that the typical operating frequency is 280 kHz. In this configuration, it is necessary to place the output filter shown in [Figure 1: Typical application schematics](#) as close as possible to the TS2012.

## 5 Package information

In order to meet environmental requirements, ST offers these devices in different grades of ECOPACK<sup>®</sup> packages, depending on their level of environmental compliance. ECOPACK<sup>®</sup> specifications, grade definitions and product status are available at: [www.st.com](http://www.st.com). ECOPACK<sup>®</sup> is an ST trademark.

### 5.1 QFN20 package information

The QFN20 package has an exposed pad E2 x D2. For enhanced thermal performance, the exposed pad must be soldered to a copper area on the PCB, acting as a heatsink. This copper area can be electrically connected to pin 4, 12, 18 (PGND, AGND) or left floating.

**Figure 47. QFN20 package mechanical drawing**

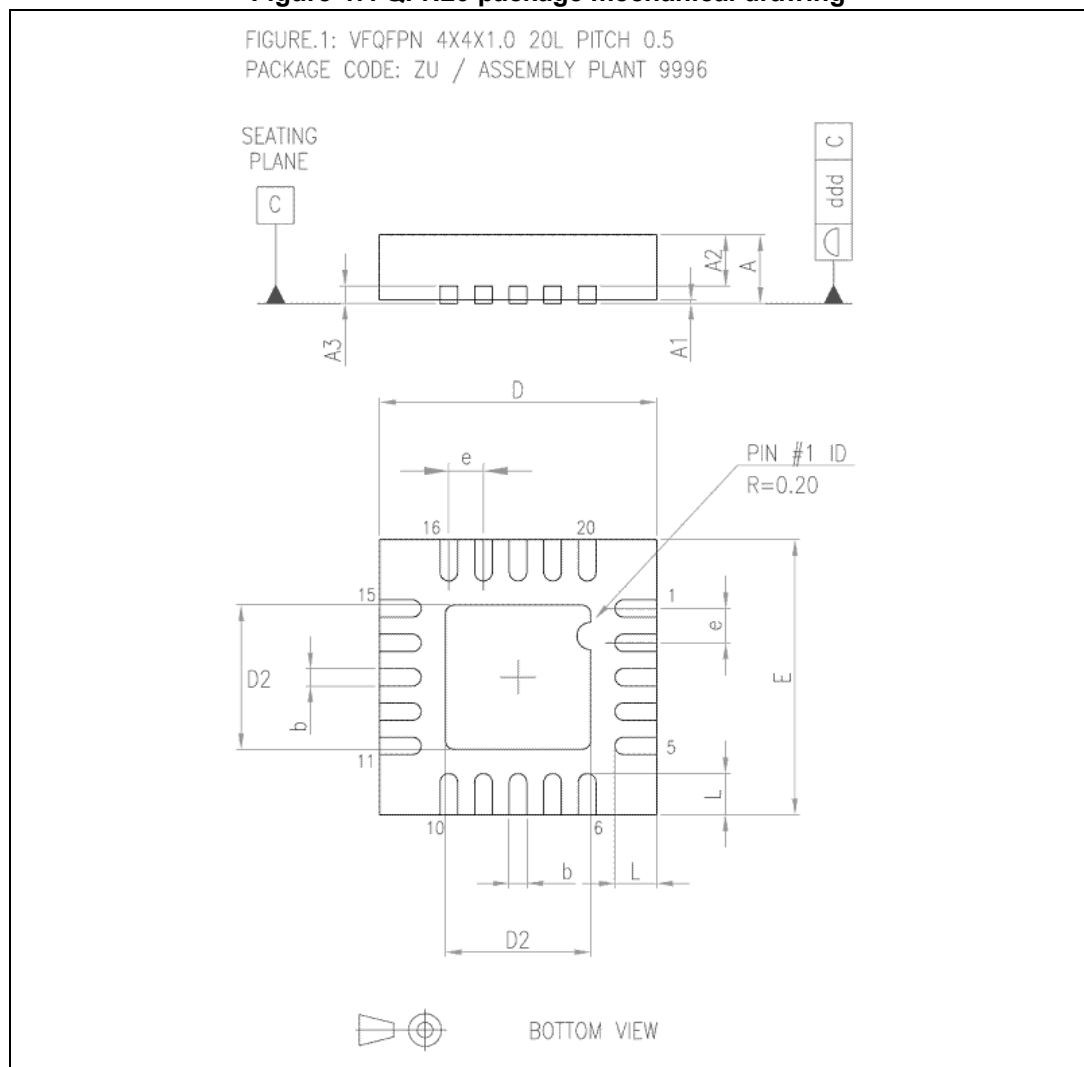

Table 10. QFN20 package mechanical data

Ref	Dimensions in mm			Dimensions in inches		
	Min	Typ	Max	Min	Typ	Max
A	0.8	0.9	1	0.031	0.035	0.039
A1		0.02	0.05		0.001	0.002
A2		0.65	1		0.026	0.039
A3		0.25			0.010	
b	0.18	0.23	0.3	0.007	0.009	0.012
D	3.85	4	4.15	0.152	0.157	0.163
D2		2.6			0.102	
E	3.85	4	4.15	0.152	0.157	0.163
E2		2.6			0.102	
e	0.45	0.5	0.55	0.018	0.020	0.022
L	0.3	0.4	0.5	0.012	0.016	0.020
ddd			0.08			0.003

Figure 48. QFN20 footprint recommendation

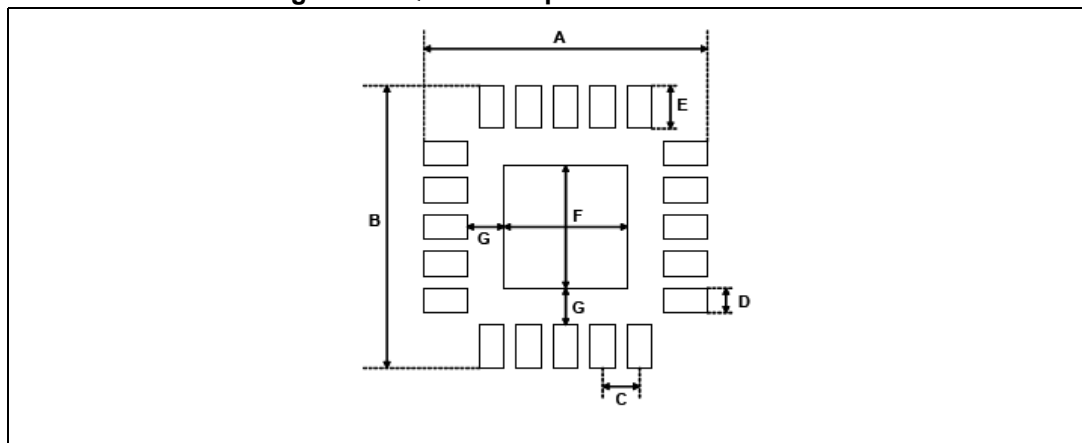

Table 11. QFN20 footprint data

Ref.	Dimensions in mm	Dimensions in inches
A	4.55	0.179
B		
C	0.50	0.020
D	0.35	0.014
E	0.65	0.026
F	2.45	0.096
G	0.40	0.016

## 6 Ordering information

Table 12. Order code

Part number	Temperature range	Package	Packaging	Marking
TS2012IQT	-40 °C to +85 °C	QFN20	Tape and reel	K012

## 7 Revision history

Table 13. Document revision history

Date	Revision	Changes
17-Dec-2007	1	First release.
17-Jul-2013	2	Small text changes throughout document. Updated titles of <a href="#">Figure 6</a> to <a href="#">Figure 11</a> and <a href="#">Figure 16</a> to <a href="#">Figure 44</a> <a href="#">Table 10: QFN20 package mechanical data</a> : added package mechanical dimensions in inches. Added <a href="#">Table 11: QFN20 footprint data</a> <a href="#">Table 12: Order code</a> ; updated "Marking"

**Please Read Carefully:**

Information in this document is provided solely in connection with ST products. STMicroelectronics NV and its subsidiaries ("ST") reserve the right to make changes, corrections, modifications or improvements, to this document, and the products and services described herein at any time, without notice.

All ST products are sold pursuant to ST's terms and conditions of sale.

Purchasers are solely responsible for the choice, selection and use of the ST products and services described herein, and ST assumes no liability whatsoever relating to the choice, selection or use of the ST products and services described herein.

No license, express or implied, by estoppel or otherwise, to any intellectual property rights is granted under this document. If any part of this document refers to any third party products or services it shall not be deemed a license grant by ST for the use of such third party products or services, or any intellectual property contained therein or considered as a warranty covering the use in any manner whatsoever of such third party products or services or any intellectual property contained therein.

**UNLESS OTHERWISE SET FORTH IN ST'S TERMS AND CONDITIONS OF SALE ST DISCLAIMS ANY EXPRESS OR IMPLIED WARRANTY WITH RESPECT TO THE USE AND/OR SALE OF ST PRODUCTS INCLUDING WITHOUT LIMITATION IMPLIED WARRANTIES OF MERCHANTABILITY, FITNESS FOR A PARTICULAR PURPOSE (AND THEIR EQUIVALENTS UNDER THE LAWS OF ANY JURISDICTION), OR INFRINGEMENT OF ANY PATENT, COPYRIGHT OR OTHER INTELLECTUAL PROPERTY RIGHT.**

**ST PRODUCTS ARE NOT AUTHORIZED FOR USE IN WEAPONS. NOR ARE ST PRODUCTS DESIGNED OR AUTHORIZED FOR USE IN: (A) SAFETY CRITICAL APPLICATIONS SUCH AS LIFE SUPPORTING, ACTIVE IMPLANTED DEVICES OR SYSTEMS WITH PRODUCT FUNCTIONAL SAFETY REQUIREMENTS; (B) AERONAUTIC APPLICATIONS; (C) AUTOMOTIVE APPLICATIONS OR ENVIRONMENTS, AND/OR (D) AEROSPACE APPLICATIONS OR ENVIRONMENTS. WHERE ST PRODUCTS ARE NOT DESIGNED FOR SUCH USE, THE PURCHASER SHALL USE PRODUCTS AT PURCHASER'S SOLE RISK, EVEN IF ST HAS BEEN INFORMED IN WRITING OF SUCH USAGE, UNLESS A PRODUCT IS EXPRESSLY DESIGNATED BY ST AS BEING INTENDED FOR "AUTOMOTIVE, AUTOMOTIVE SAFETY OR MEDICAL" INDUSTRY DOMAINS ACCORDING TO ST PRODUCT DESIGN SPECIFICATIONS. PRODUCTS FORMALLY ESCC, QML OR JAN QUALIFIED ARE DEEMED SUITABLE FOR USE IN AEROSPACE BY THE CORRESPONDING GOVERNMENTAL AGENCY.**

Resale of ST products with provisions different from the statements and/or technical features set forth in this document shall immediately void any warranty granted by ST for the ST product or service described herein and shall not create or extend in any manner whatsoever, any liability of ST.

ST and the ST logo are trademarks or registered trademarks of ST in various countries.

Information in this document supersedes and replaces all information previously supplied.

The ST logo is a registered trademark of STMicroelectronics. All other names are the property of their respective owners.

© 2013 STMicroelectronics - All rights reserved

STMicroelectronics group of companies

Australia - Belgium - Brazil - Canada - China - Czech Republic - Finland - France - Germany - Hong Kong - India - Israel - Italy - Japan - Malaysia - Malta - Morocco - Philippines - Singapore - Spain - Sweden - Switzerland - United Kingdom - United States of America

[www.st.com](http://www.st.com)

