



BD707/709/711 BD708/712

COMPLEMENTARY SILICON POWER TRANSISTORS

■ COMPLEMENTARY PNP - NPN DEVICES

APPLICATION

- LINEAR AND SWITCHING INDUSTRIAL EQUIPMENT

DESCRIPTION

The BD707, BD709 and BD711 are silicon Epitaxial-Base NPN power transistors in Jedec TO-220 plastic package. They are intended for use in power linear and switching applications.

The BD707 and BD711 complementary PNP types are BD708 and BD712 respectively.

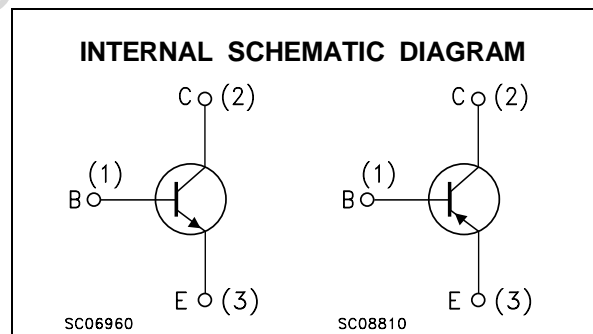
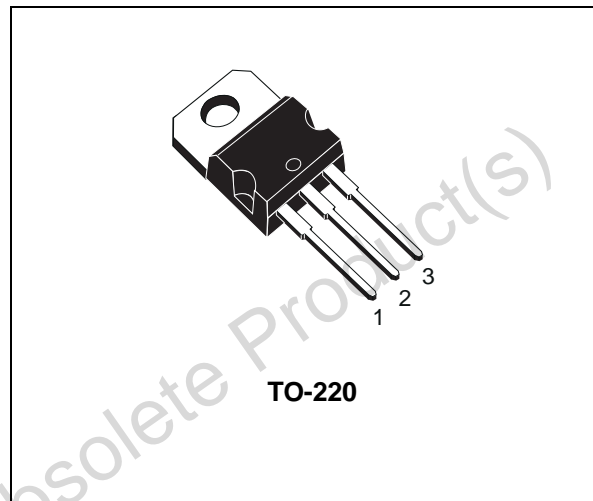

ABSOLUTE MAXIMUM RATINGS

Symbol	Parameter	Value			Unit	
		NPN	BD707	BD709		BD711
		PNP	BD708			BD712
V_{CBO}	Collector-Base Voltage ($I_E = 0$)		60	80	100	V
V_{CER}	Collector-Emitter Voltage ($V_{BE} = 0$)		60	80	100	V
V_{CEO}	Collector-Emitter Voltage ($I_B = 0$)		60	80	100	V
V_{EBO}	Emitter-Base Voltage ($I_C = 0$)		5			V
I_C	Collector Current		12			A
I_{CM}	Collector Peak Current		18			A
I_B	Base Current		5			A
P_{tot}	Total Dissipation at $T_c \leq 25^\circ\text{C}$		75			W
T_{stg}	Storage Temperature		-65 to 150			$^\circ\text{C}$
T_j	Max. Operating Junction Temperature		150			$^\circ\text{C}$

For PNP types voltage and current values are negative

BD707/708/709/711/712

THERMAL DATA

R _{thj-case}	Thermal Resistance Junction-case	Max	1.67	°C/W
R _{thj-case}	Thermal Resistance Junction-ambient	Max	70	°C/W

ELECTRICAL CHARACTERISTICS (T_{case} = 25 °C unless otherwise specified)

Symbol	Parameter	Test Conditions	Min.	Typ.	Max.	Unit
I _{CBO}	Collector Cut-off Current (I _E = 0)	for BD707/708 V _{CB} = 60 V for BD709 V _{CB} = 80 V for BD711/712 V _{CB} = 100 V T _{case} = 150 °C for BD707/708 V _{CB} = 60 V for BD709 V _{CB} = 80 V for BD711/712 V _{CB} = 100 V			100 100 100 1 1 1	μA μA μA mA mA mA
I _{CEO}	Collector Cut-off Current (I _B = 0)	for BD707/708 V _{CE} = 30 V for BD709 V _{CE} = 40 V for BD711/712 V _{CE} = 50 V			100 100 100	mA mA mA
I _{EBO}	Emitter Cut-off Current (I _C = 0)	V _{EB} = 5 V			1	mA
V _{CEO(sus)*}	Collector-Emitter Sustaining Voltage (I _B = 0)	I _C = 100 mA for BD707/708 for BD709 for BD711/712	60 80 100			V V V
V _{CE(sat)*}	Collector-Emitter Saturation Voltage	I _C = 4 A I _B = 0.4 A			1	V
V _{CEK*}	Knee Voltage	I _C = 3 A I _B = **			0.4	V
V _{BE*}	Base-Emitter Voltage	I _C = 4 A V _{CE} = 4 V			1.5	V
h _{FE*}	DC Current Gain	I _C = 0.5 A V _{CE} = 2 V I _C = 2 A V _{CE} = 2 V for BD707/708 for BD709 I _C = 4 A V _{CE} = 4 V I _C = 10 A V _{CE} = 4 V for BD707/708 for BD709 for BD711/712	40 30 30 15 5	120 10	400 150 8 8	
f _T	Transition frequency	I _C = 300 mA V _{CE} = 3 V	3			MHz

* Pulsed: Pulse duration = 300 μs, duty cycle 1.5 %

** Value for which I_C = 3.3 A at V_{CE} = 2V.

For PNP types voltage and current values are negative.

Safe Operating Areas

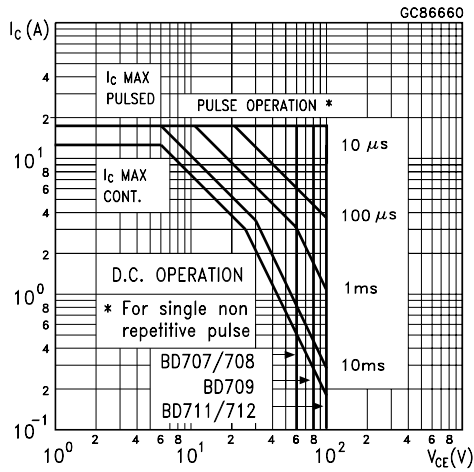

Derating Curve

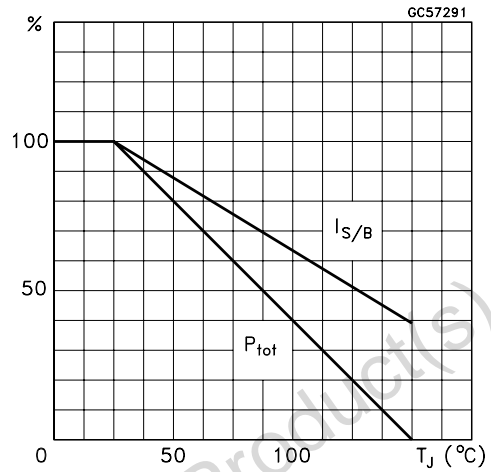

DC Current Gain(NPN type)

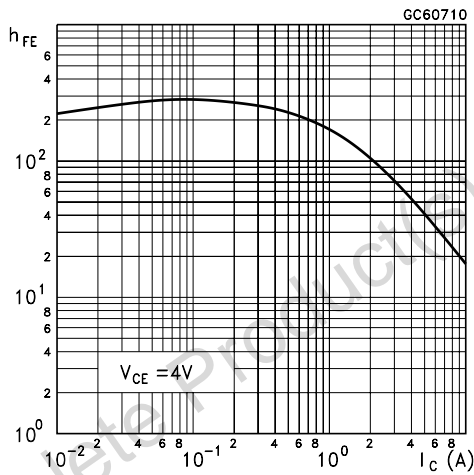

DC Current Gain(PNP type)

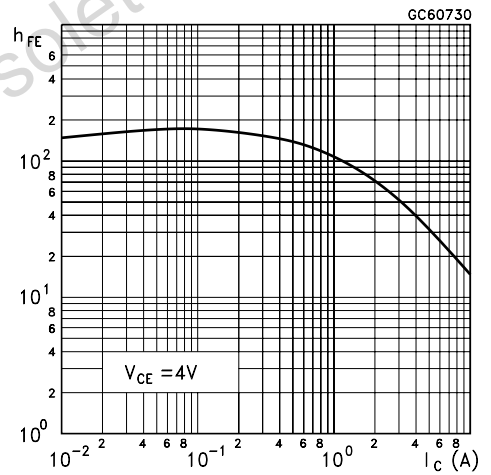

DC Transconductance(NPN type)

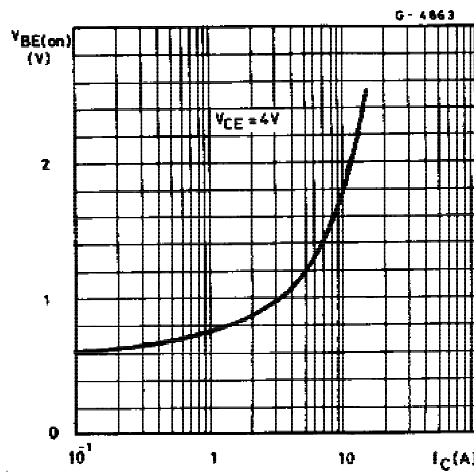

DC Transconductance(PNP type)

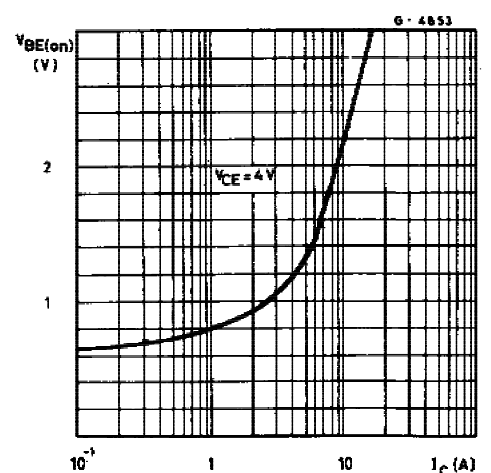

Collector-Emitter Saturation Voltage (NPN type)

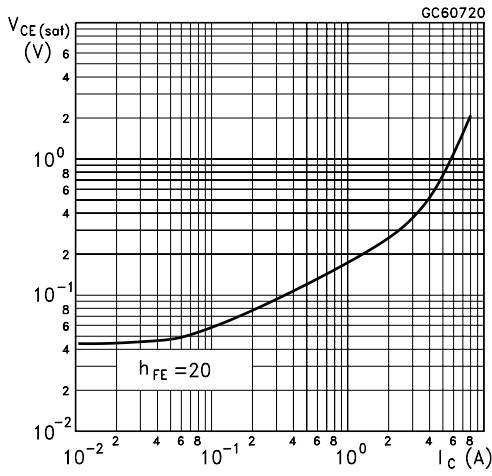

Collector-Emitter Saturation Voltage (PNP type)

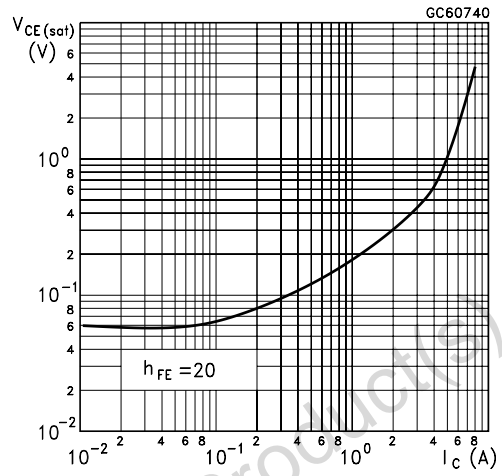

Base-Emitter Saturation Voltage (NPN type)

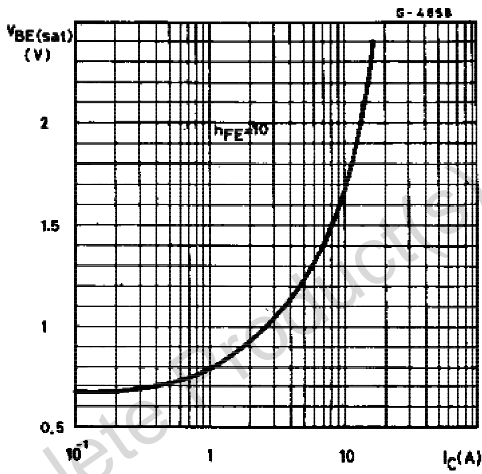

Base-Emitter Saturation Voltage (PNP type)

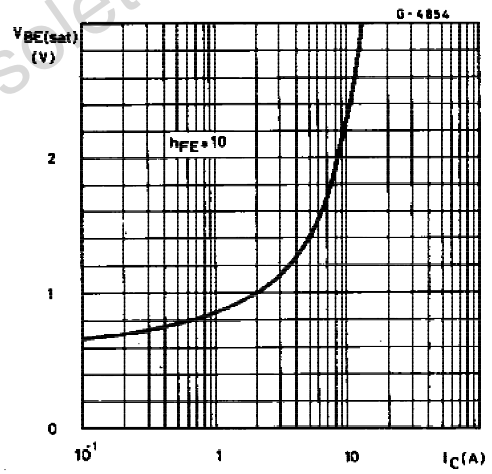

Transition Frequency (NPN type)

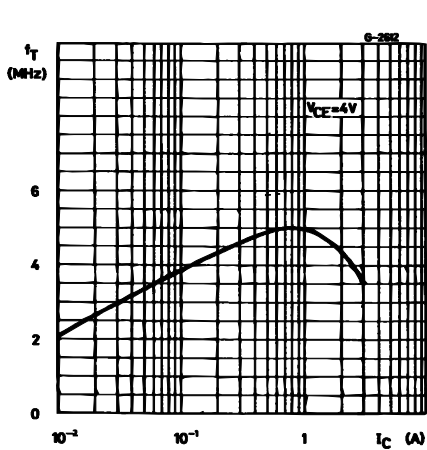

Transition Frequency (PNP type)

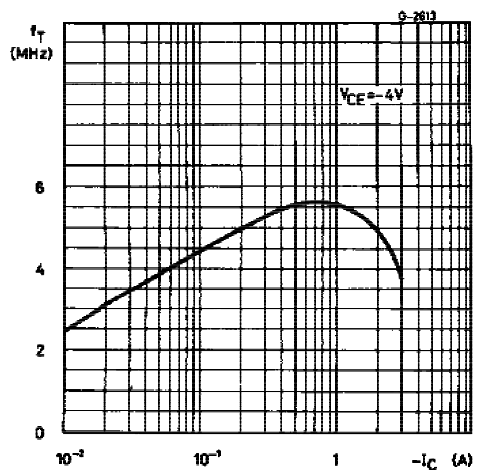

TO-220 MECHANICAL DATA

DIM.	mm			inch		
	MIN.	TYP.	MAX.	MIN.	TYP.	MAX.
A	4.40		4.60	0.173		0.181
C	1.23		1.32	0.048		0.051
D	2.40		2.72	0.094		0.107
D1		1.27			0.050	
E	0.49		0.70	0.019		0.027
F	0.61		0.88	0.024		0.034
F1	1.14		1.70	0.044		0.067
F2	1.14		1.70	0.044		0.067
G	4.95		5.15	0.194		0.203
G1	2.4		2.7	0.094		0.106
H2	10.0		10.40	0.393		0.409
L2		16.4			0.645	
L4	13.0		14.0	0.511		0.551
L5	2.65		2.95	0.104		0.116
L6	15.25		15.75	0.600		0.620
L7	6.2		6.6	0.244		0.260
L9	3.5		3.93	0.137		0.154
DIA.	3.75		3.85	0.147		0.151

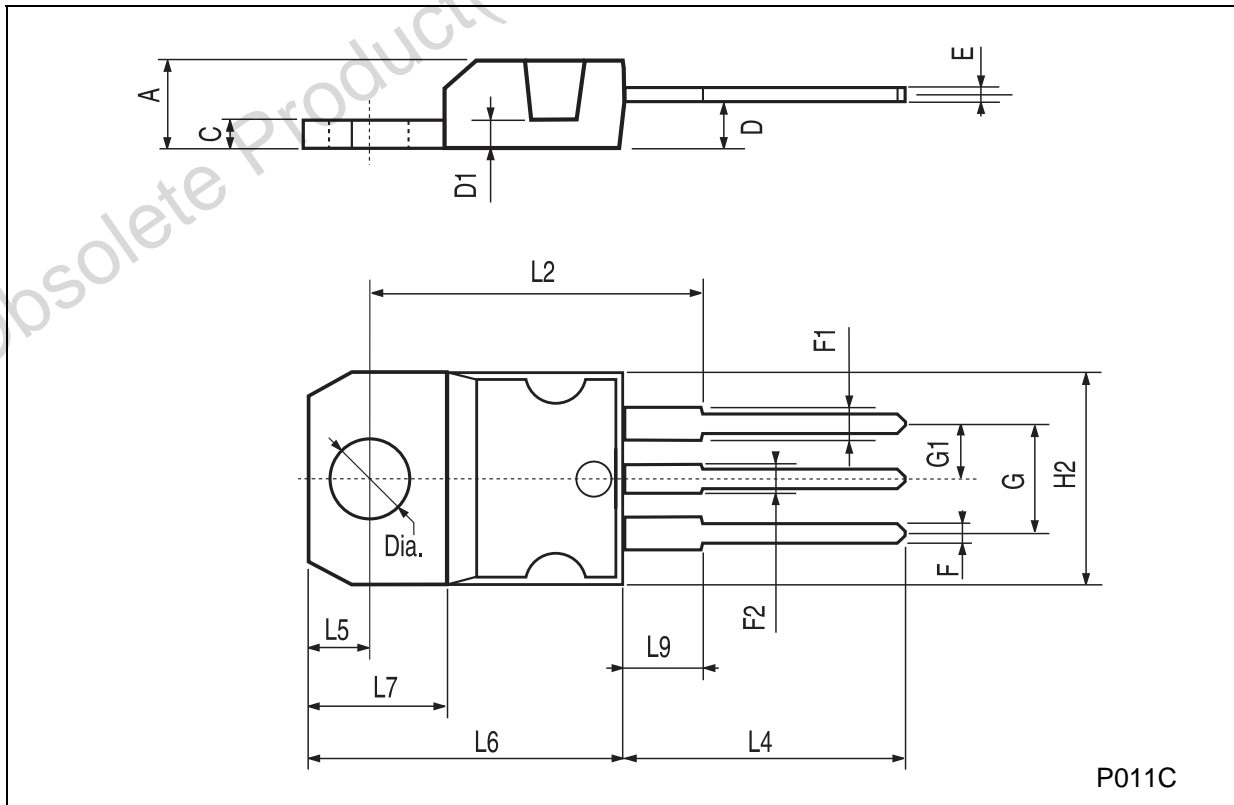

P011C

Obsolete Product(s) - Obsolete Product(s)

Information furnished is believed to be accurate and reliable. However, STMicroelectronics assumes no responsibility for the consequences of use of such information nor for any infringement of patents or other rights of third parties which may result from its use. No license is granted by implication or otherwise under any patent or patent rights of STMicroelectronics. Specification mentioned in this publication are subject to change without notice. This publication supersedes and replaces all information previously supplied. STMicroelectronics products are not authorized for use as critical components in life support devices or systems without express written approval of STMicroelectronics.

The ST logo is a trademark of STMicroelectronics

© 1999 STMicroelectronics – Printed in Italy – All Rights Reserved

STMicroelectronics GROUP OF COMPANIES

Australia - Brazil - China - Finland - France - Germany - Hong Kong - India - Italy - Japan - Malaysia - Malta - Morocco - Singapore - Spain - Sweden - Switzerland - United Kingdom - U.S.A.

<http://www.st.com>