

Power Schottky rectifier

Datasheet - production data

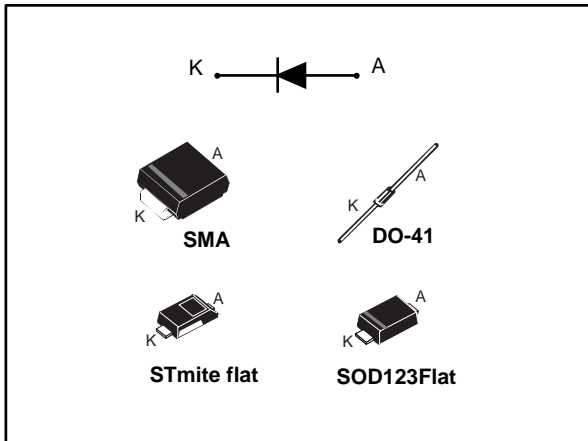

Description

Axial and surface mount power Schottky rectifiers suited to switched mode power supplies and high frequency DC to DC converters.

Packaged in SMA, STmite flat, DO-41 and SOD123Flat, this device is especially intended for use in low voltage, high frequency inverters and small battery chargers.

Table 1: Device summary

Symbol	Value
$I_{F(AV)}$	1 A
V_{RRM}	60 V
$V_F(\text{typ.})$	0.50 V
$T_j(\text{max.})$	175 °C

Features

- Negligible switching losses
- Low forward voltage drop
- Surface mount miniature packages
- Avalanche capability specified

1 Characteristics

Table 2: Absolute ratings (limiting values at 25 °C, unless otherwise specified)

Symbol	Parameter		Value	Unit	
V _{RRM}	Repetitive peak reverse voltage		60	V	
I _{F(RMS)}	Forward rms current		SMA/DO-41	10	A
			STmite flat	2	
I _{F(AV)}	Average forward current δ = 0.5, square wave	SMA	T _L = 155 °C	1	A
		DO-41	T _L = 145 °C		
		SOD123Flat	T _L = 160 °C		
		STmite flat	T _C = 160 °C		
I _{FSM}	Surge non repetitive forward current	SMA DO-41 STmite flat	t _p = 10 ms sinusoidal	40	A
		SOD123Flat		50	
		Repetitive peak avalanche power		t _p = 10 μs, T _j = 125 °C	
T _{stg}	Storage temperature range		-65 to +175	°C	
T _j	Operating junction temperature range ⁽¹⁾		-40 to +175	°C	

Notes:

⁽¹⁾(dP_{tot}/dT_j) < (1/R_{th(j-a)}) condition to avoid thermal runaway for a diode on its own heatsink.

Table 3: Thermal parameters

Symbol	Parameter	Max. value	Unit	
R _{th(j-l)}	Junction to lead	SMA	30	°C/W
		DO-41/lead length = 10 mm	45	
		SOD123Flat	20	
R _{th(j-c)}	Junction to case	STmite flat	20	

Table 4: Static electrical characteristics

Symbol	Parameter	Test conditions		Min.	Typ.	Max.	Unit
$I_R^{(1)}$	Reverse leakage current	$T_j = 25\text{ °C}$	$V_R = V_{RRM}$	-		50	μA
		$T_j = 100\text{ °C}$		-	1.5	5	mA
		$T_j = 125\text{ °C}$		-	5.6	21	
$V_F^{(1)}$	Forward voltage drop	$T_j = 25\text{ °C}$	$I_F = 1\text{ A}$	-		0.57	V
		$T_j = 125\text{ °C}$		-	0.50	0.54	
		$T_j = 25\text{ °C}$	$I_F = 2\text{ A}$	-		0.75	
		$T_j = 125\text{ °C}$		-	0.60	0.66	

Notes:

⁽¹⁾Pulse test: $t_p = 380\text{ }\mu\text{s}$, $\delta < 2\%$

To evaluate the conduction losses, use the following equation:

$$P = 0.42 \times I_{F(AV)} + 0.12 \times I_{F(RMS)}^2$$

1.1 Characteristics (curves)

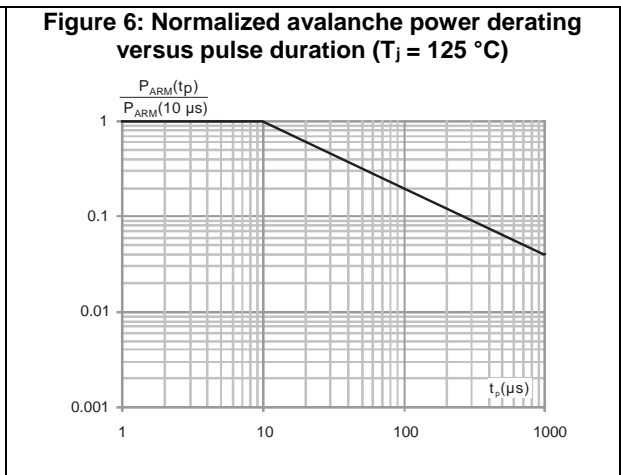
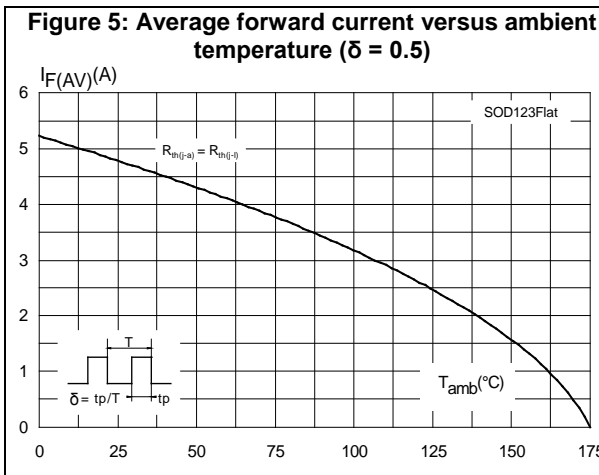
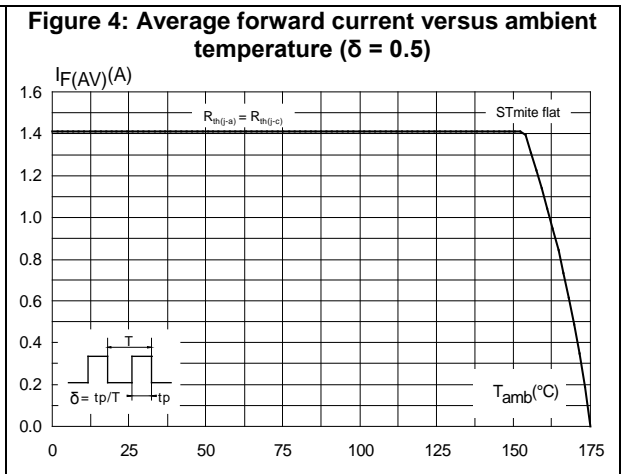
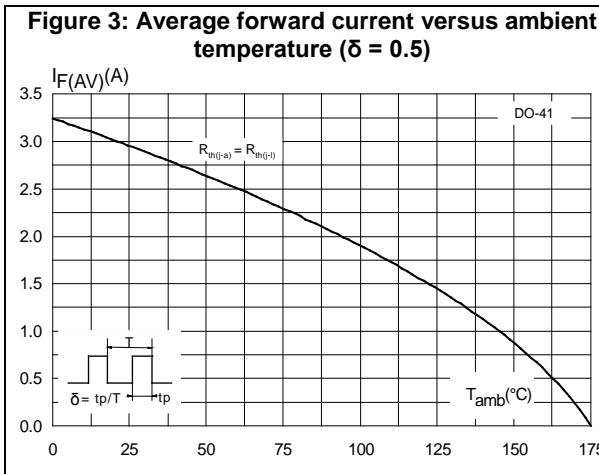
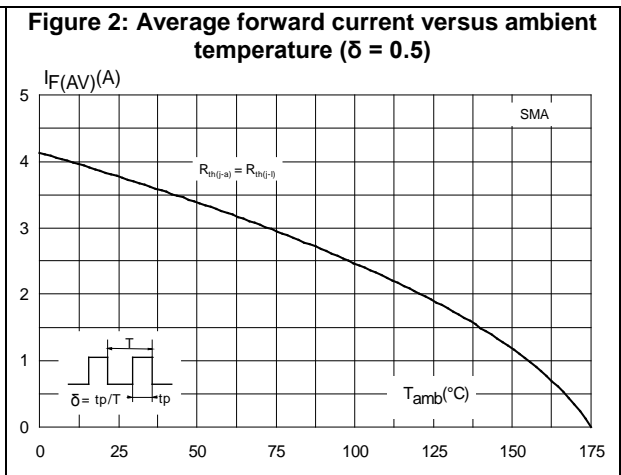
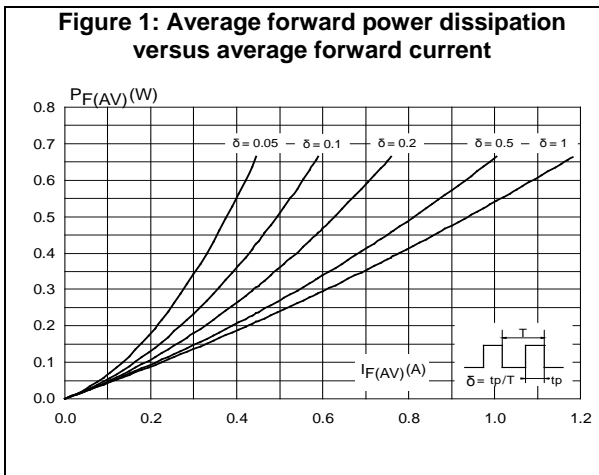

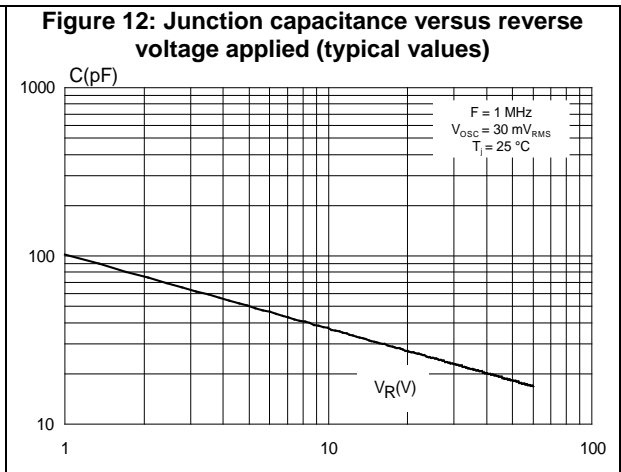
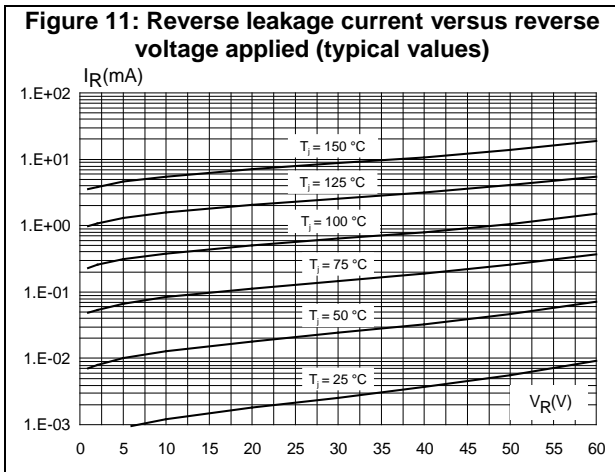
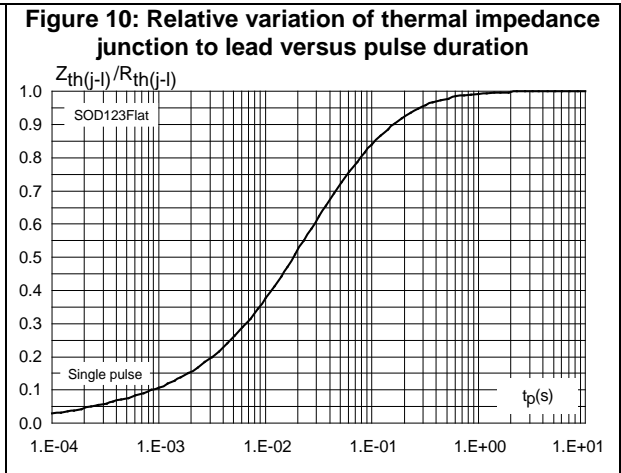
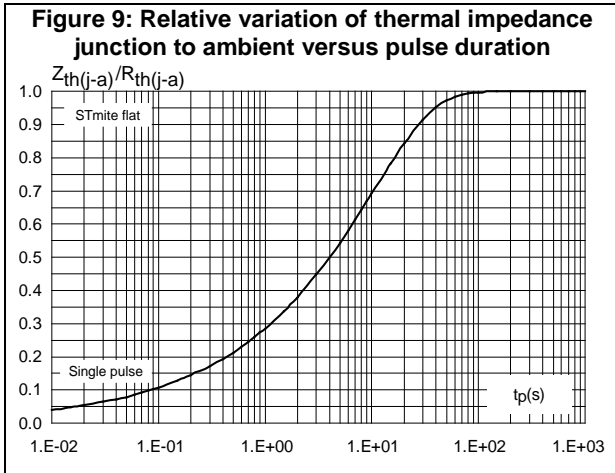
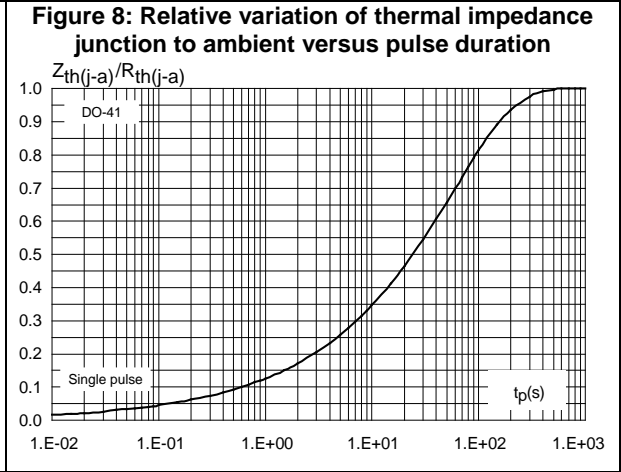
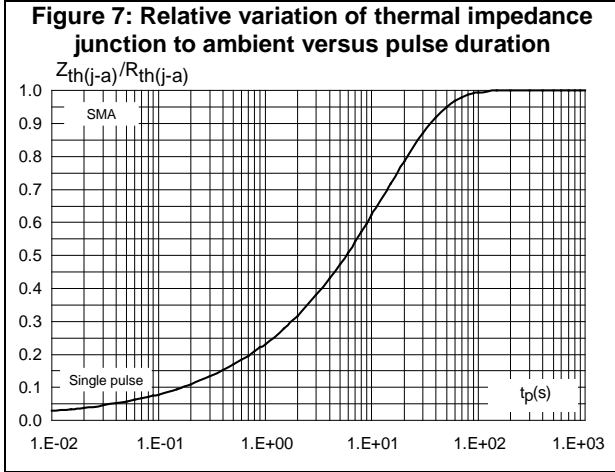

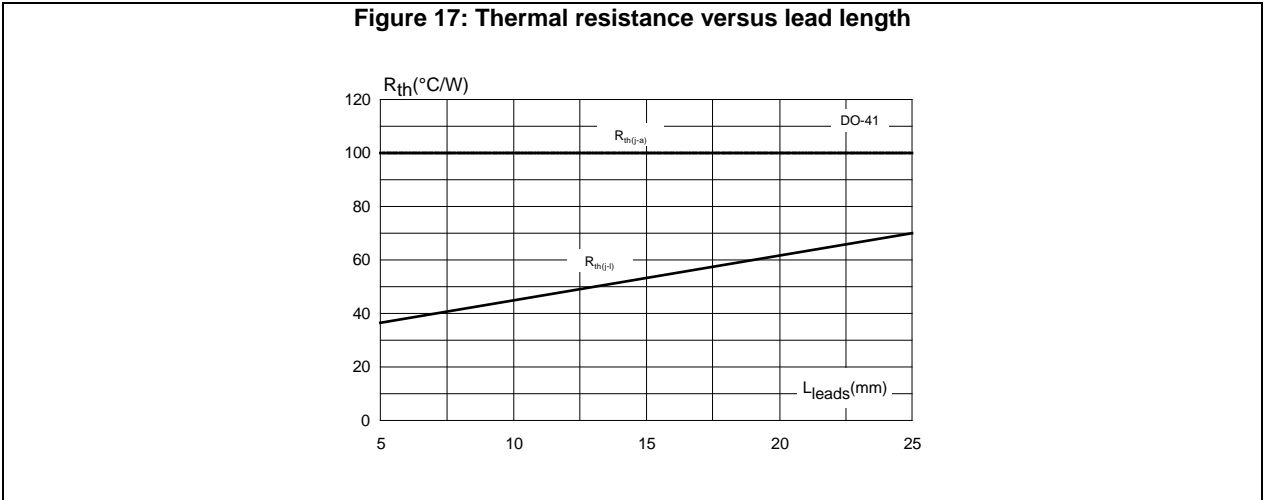
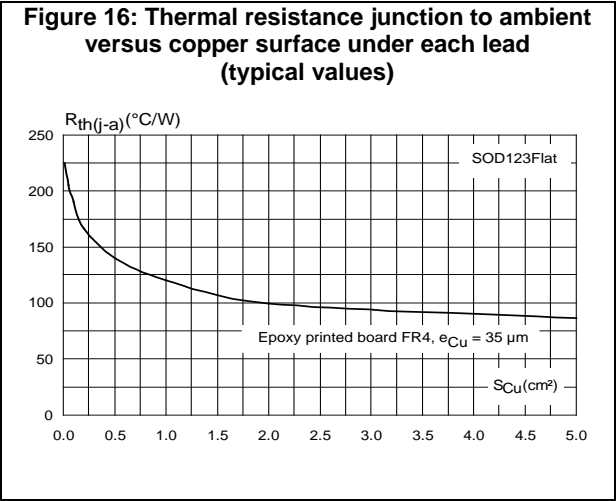
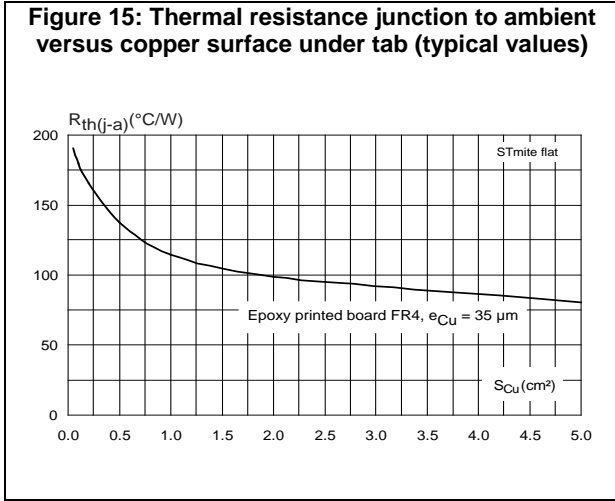
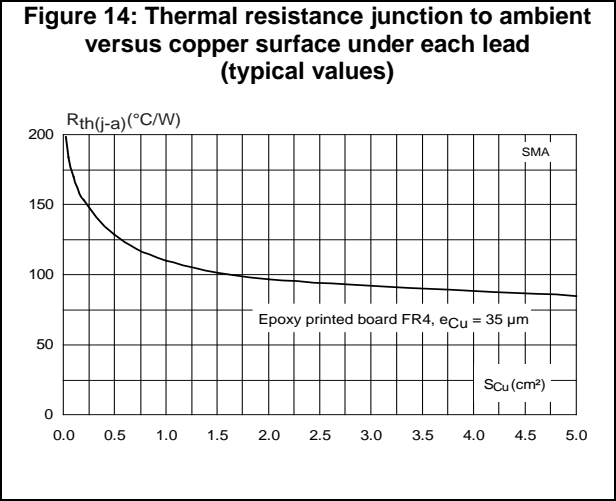
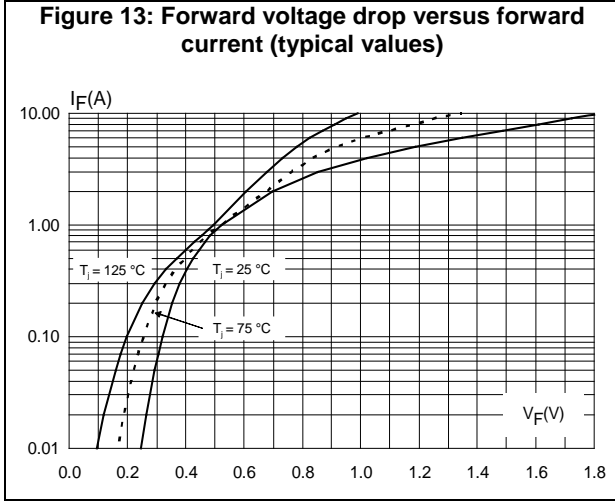

2 Package information

In order to meet environmental requirements, ST offers these devices in different grades of ECOPACK® packages, depending on their level of environmental compliance. ECOPACK® specifications, grade definitions and product status are available at: www.st.com. ECOPACK® is an ST trademark.

- Epoxy meets UL94, V0
- Band indicates cathode

2.1 SMA package information

Figure 18: SMA package outline

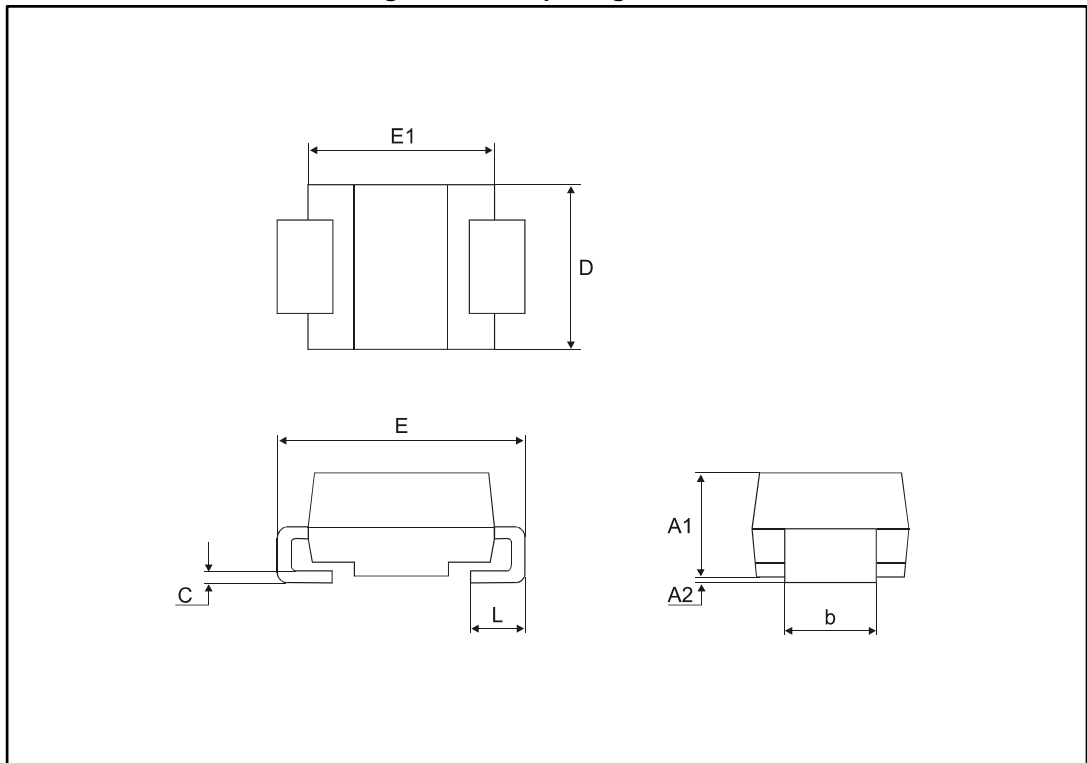
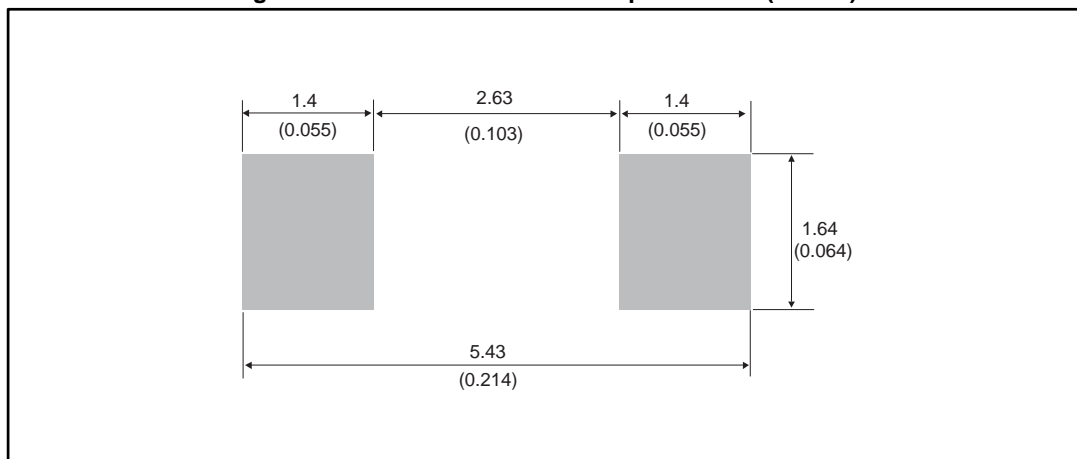

Table 5: SMA package mechanical data

Ref.	Dimensions			
	Millimeters		Inches	
	Min.	Max.	Min.	Max.
A1	1.90	2.45	0.075	0.097
A2	0.05	0.20	0.002	0.008
b	1.25	1.65	0.049	0.065
c	0.15	0.40	0.006	0.016
D	2.25	2.90	0.089	0.114
E	4.80	5.35	0.189	0.211
E1	3.95	4.60	0.156	0.181
L	0.75	1.50	0.030	0.059

Figure 19: SMA recommended footprint in mm (inches)



2.2 DO-41 package information

Figure 20: DO-41 package outline

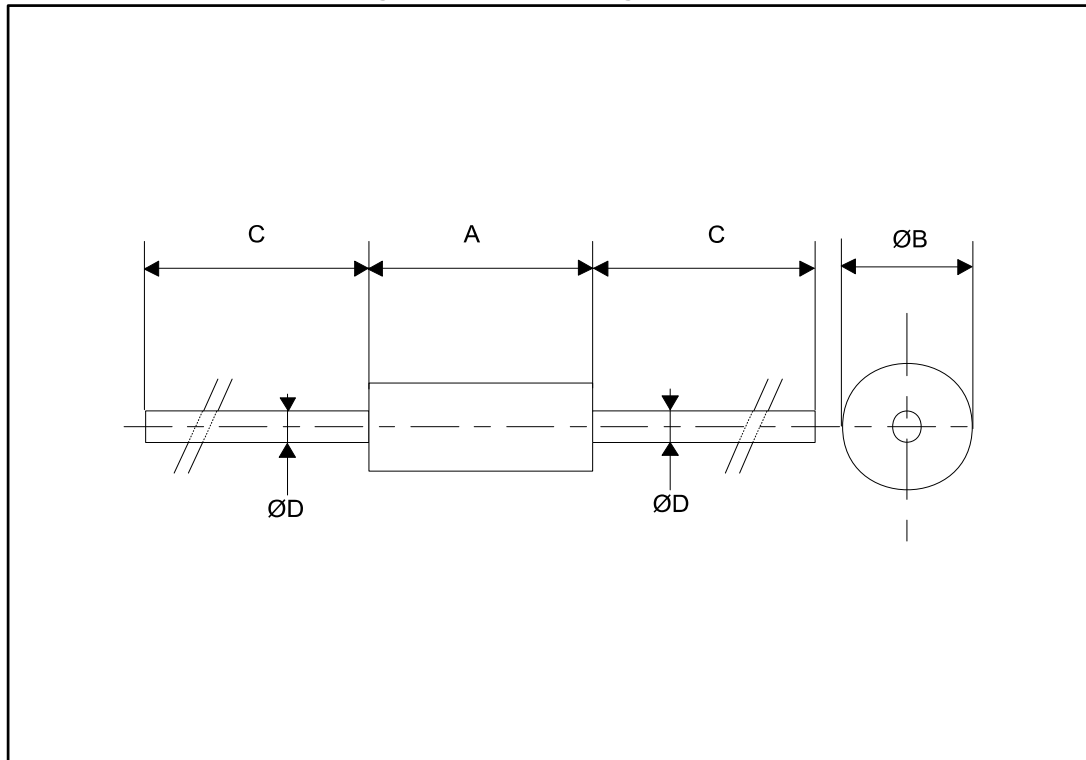

Table 6: DO-41 package mechanical data

Ref.	Dimensions			
	Millimeters		Inches	
	Min.	Max.	Min.	Max.
A	4.07	5.20	0.160	0.205
ØB	2.04	2.71	0.080	0.107
C	25.40		1	
ØD	0.71	0.86	0.028	0.034

2.3 STmite flat package information

Figure 21: STmite flat package outline

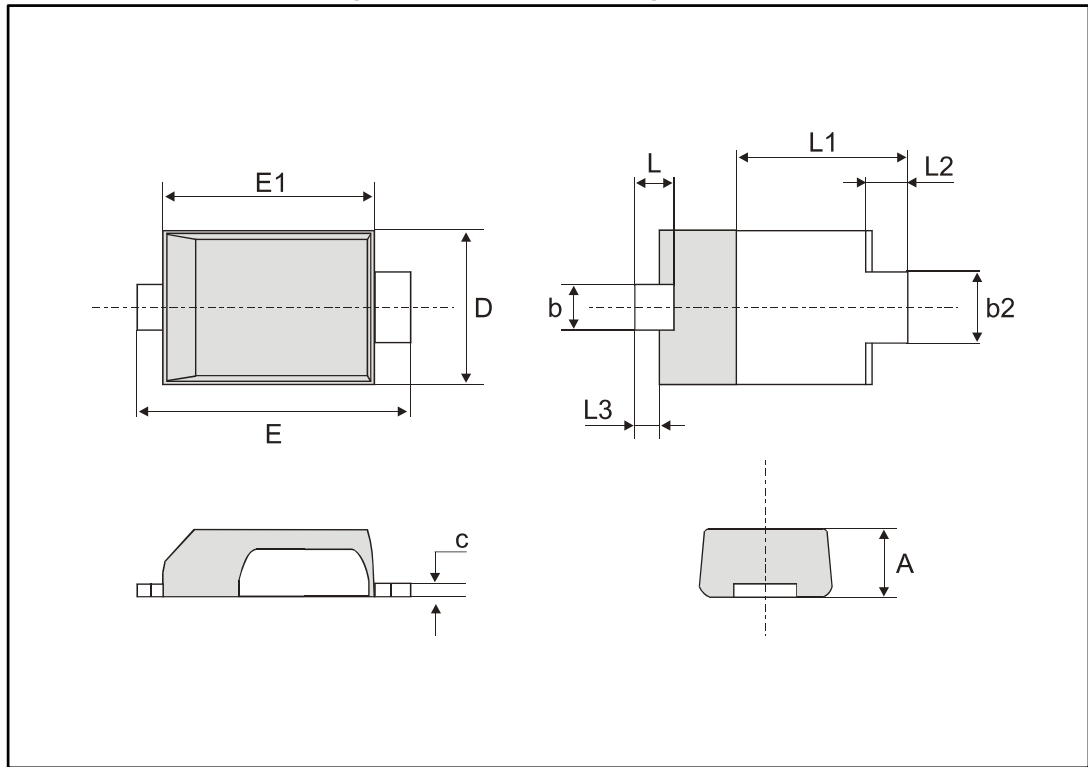
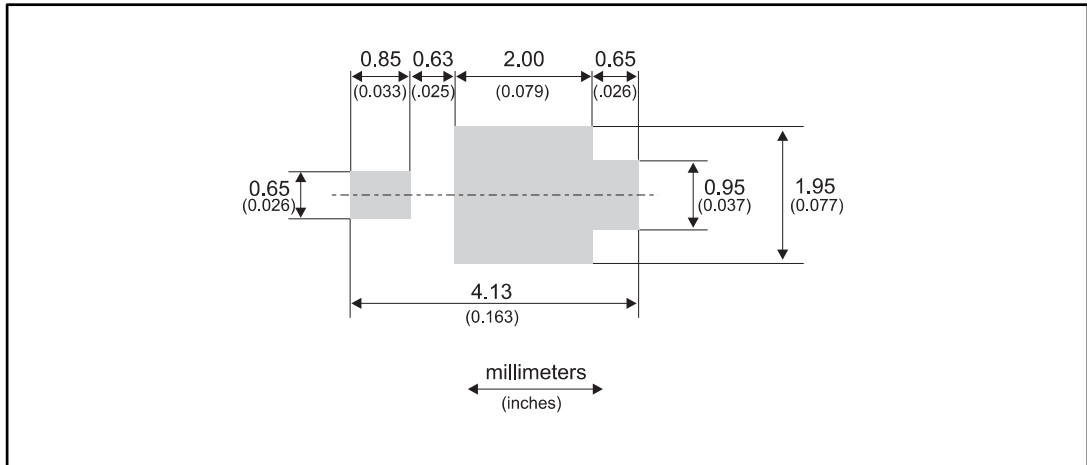

Table 7: STmite flat package mechanical data

Ref.	Dimensions					
	Millimeters			Inches		
	Min.	Typ.	Max.	Min.	Typ.	Max.
A	0.80	0.85	0.95	0.031	0.033	0.037
b	0.40	0.55	0.65	0.016	0.022	0.026
b2	0.70	0.85	1.00	0.027	0.033	0.039
c	0.10	0.15	0.25	0.004	0.006	0.009
D	1.75	1.90	2.05	0.069	0.075	0.081
E	3.60	3.80	3.90	0.142	0.150	0.154
E1	2.80	2.95	3.10	0.110	0.116	0.122
L	0.50	0.55	0.80	0.020	0.022	0.031
L1	2.10	2.40	2.60	0.083	0.094	0.102
L2	0.45	0.60	0.75	0.018	0.021	0.030
L3	0.20	0.35	0.50	0.008	0.014	0.020

Figure 22: STmite flat recommended footprint in mm (inches)



2.4 SOD123Flat package information

Figure 23: SOD123Flat package outline

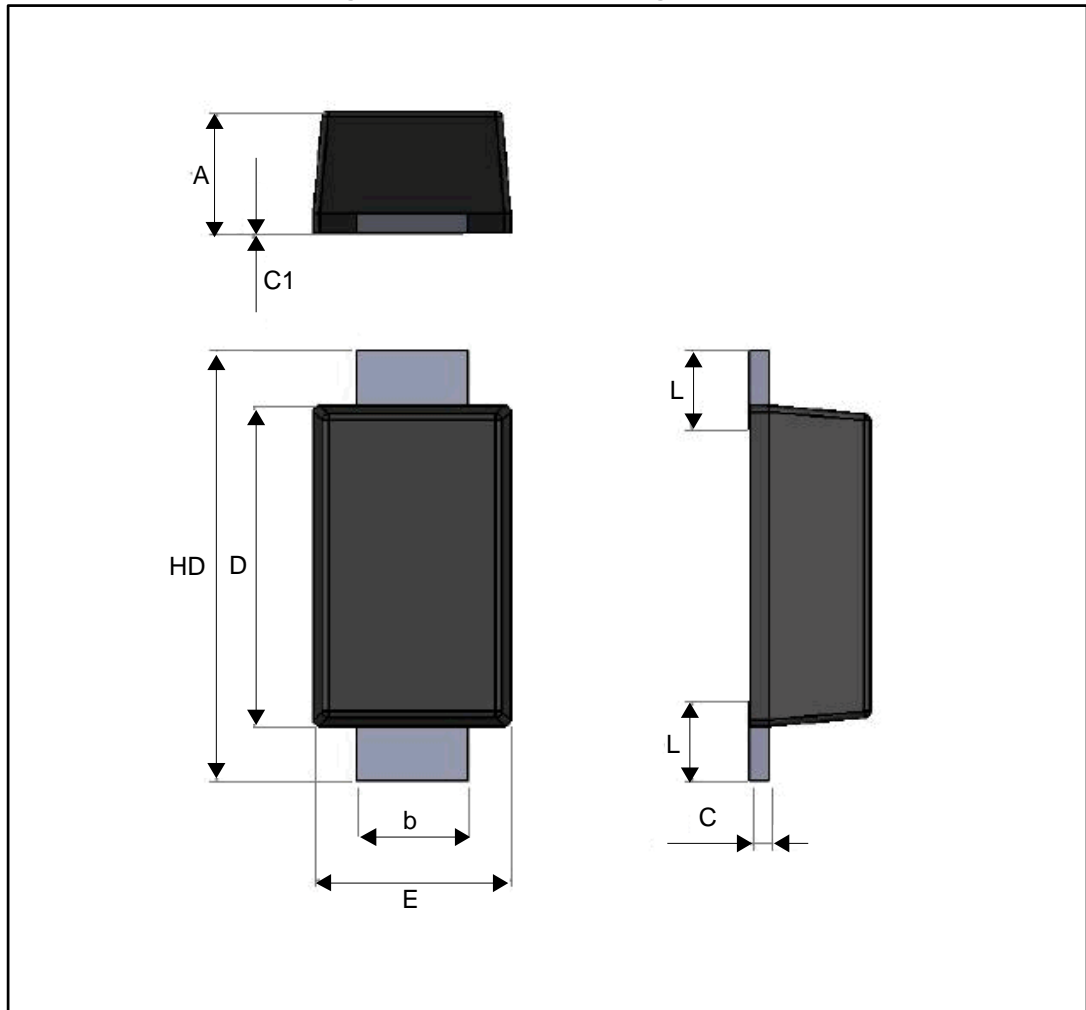
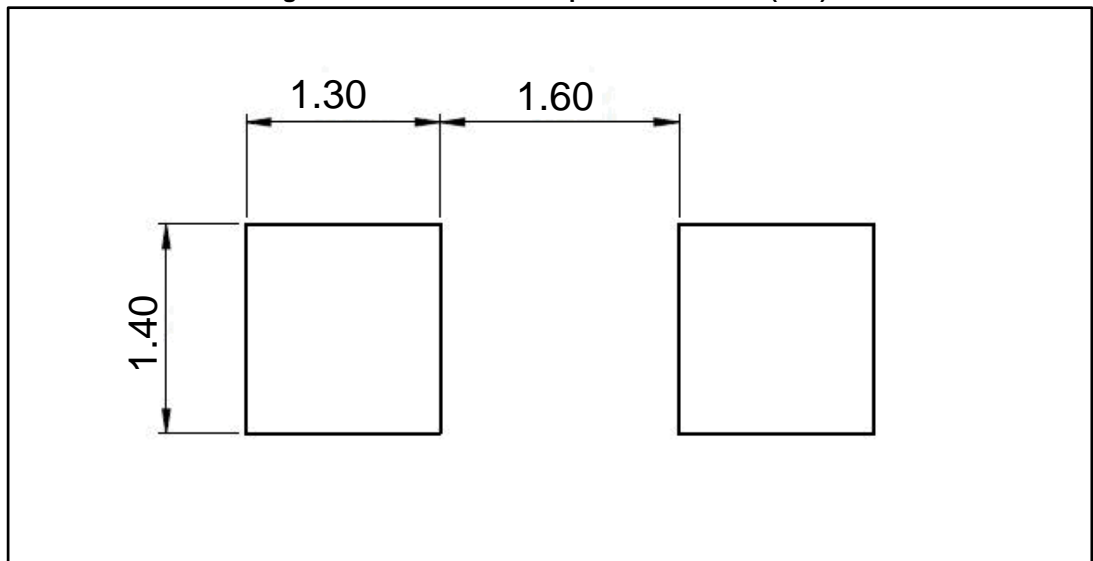

Table 8: SOD123Flat package mechanical data

Ref.	Dimensions		
	Millimeters		
	Min.	Typ.	Max.
A	0.86	0.98	1.10
b	0.80	0.90	1.00
c	0.08	0.15	0.25
c1	0.00		0.10
D	2.50	2.60	2.70
E	1.50	1.60	1.80
HD	3.30	3.50	3.70
L	0.45	0.65	0.85

Figure 24: SOD123Flat footprint dimensions (mm)



3 Ordering information

Table 9: Ordering information

Order code	Marking	Package	Weight	Base qty.	Delivery mode
STPS1L60A	GB6	SMA	68 mg	5000	Tape and reel
STPS1L60RL	STPS1L60	DO-41	340 mg	5000	Tape and reel
STPS1L60MF	F1L6	STmite flat	16 mg	12000	Tape and reel
STPS1L60ZF	1L6	SOD123Flat	12.5 mg	3000	Tape and reel

4 Revision history

Table 10: Document revision history

Date	Revision	Changes
Jul-2003	5A	Last update.
Aug-2004	6	SMA package dimensions update. Reference A1 max. changed from 2.70 mm (0.106 inch.) to 2.03 mm (0.080 inc.).
25-Jun-2009	7	Added STmite flat package. Updated ECOPACK statement
30-Sep-2009	8	Updated table 7 ref. "C"
19-Aug-2016	9	Added SOD123Flat package.
26-Aug-2016	10	Updated table 4 .

IMPORTANT NOTICE – PLEASE READ CAREFULLY

STMicroelectronics NV and its subsidiaries ("ST") reserve the right to make changes, corrections, enhancements, modifications, and improvements to ST products and/or to this document at any time without notice. Purchasers should obtain the latest relevant information on ST products before placing orders. ST products are sold pursuant to ST's terms and conditions of sale in place at the time of order acknowledgement.

Purchasers are solely responsible for the choice, selection, and use of ST products and ST assumes no liability for application assistance or the design of Purchasers' products.

No license, express or implied, to any intellectual property right is granted by ST herein.

Resale of ST products with provisions different from the information set forth herein shall void any warranty granted by ST for such product.

ST and the ST logo are trademarks of ST. All other product or service names are the property of their respective owners.

Information in this document supersedes and replaces information previously supplied in any prior versions of this document.

© 2016 STMicroelectronics – All rights reserved