

# OsiSense® XS Inductive sensors

General purpose  
with increased range





# Helping you to find the most efficient solution

## The inductive detection function that performs and lasts

A new offer to meet the demands of machine manufacturers for increased range in inductive sensing.

### > Easy to install

Contributes to machine compactness  
Wider adjustment range

### > Robust

Solutions that last

### > Readily available

Contributes to machine performance

## Contents

Cylindrical inductive proximity sensors

Introduction	p 1 and 2
Selection guide	p 3 to 6
Three-wire DC, flush mountable, standard range	p 7 to 10
Two-wire DC, flush mountable, standard range	p 11 to 14
Two-wire AC or DC, flush mountable, standard range	p 15 and 16
Three-wire DC, flush mountable, increased range	p 17 to 20
Two-wire DC, flush mountable, increased range	p 21 and 22
Two-wire AC or DC, flush mountable, increased range	p 23 and 24
Three-wire DC, non-flush mountable, increased range	p 25 and 26
Two-wire AC or DC, non-flush mountable, increased range	p 27 and 28

Make the most of your energy<sup>SM</sup>

NOTE: Sensors described in this catalog are designed to be used for standard industrial presence sensing applications. These sensors do not include the self-checking redundant circuitry necessary to allow for their use in safety applications.

## > Contributes to machine compactness

### Easy to install:

Compact product (short), easier integration in the machine

- Increased range (x2), sensing distance easier to adjust
- All standard diameters (complete range, from Ø 6.5 to Ø 30 mm)
- Long and short product lengths to meet the most demanding dimension standards on the market
- DC and AC/DC versions available for maximum flexibility

# +100%

of the sensing distance for flush mountable models

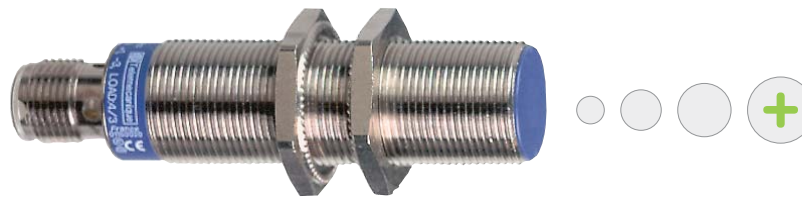

## > Increase the reliability of your solution

### Quality by design:

- Subjected to climatic cycle tests: -25 to +70 °C (-13 to 158 °F) cycle, 95% RH for 3,000 hours under power to verify their ability to maintain specifications over time.
- Resistance to electromagnetic interference—immune to high levels of EMC
- Resistance to environment—IP 65, IP 67 and IP 68 for pre-cabled versions, IP 69K for 12 and 30 mm diameter sensors



## > Contributes to machine performance

### Readily available:

- Robust products to meet your needs
- Particularly well-suited for your machines used in sectors such as machine tooling, assembly, packaging, conveying and the automotive industry.



Packaging



Automotive

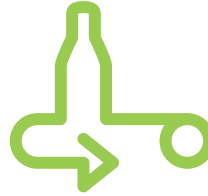

Materials handling



Machine Tooling

- Proven tried-and-tested performance with worldwide product availability
- You export your machines throughout the world. Schneider Electric has locations in 190 countries.



availability  
throughout  
the world

## General purpose flush or non-flush mountable, standard or increased range:

A global offer of high-performance inductive sensors to meet your individual needs



### XS6..B range

Metal AC or DC  
Increased range  
2.5 to 22 mm  
(0.10 to 0.87 in.)

**Flush or non-flush  
mountable**



### XS5..BL range

3-wire DC  
Metal  
Standard range  
1.5 to 10 mm  
(0.06 to 0.39 in.)

**Flush mountable**



### XS5..B1M range

2-wire AC or DC  
Metal  
Standard range  
2.0 to 10 mm  
(0.04 to 0.39 in.)

**Flush mountable**



### XS1... range

3-wire DC  
Metal  
Increased range  
2.5 to 15 mm  
(0.10 to 0.59 in.)

**Flush mountable**

# > Selection guide—General purpose inductive sensors

Flush mountable, standard range  
1.5 to 10 mm (0.06 to 0.39 in.)

Metal

3-wire DC



Format	Ø 6.5 mm plain	Ø 8 mm	Ø 12 mm	Ø 18 mm	Ø 30 mm
Sensing dist., mm (in.)	1.5 (0.06)	1.5 (0.06)	2 (0.08)	5 (0.20)	10 (0.39)
Length Short case	33 (1.30)	33 (1.30)	35 (1.38)	39 (1.54)	43 (1.69)
mm (in.) Long Case	51 (2.01)	51 (2.01)	53 (2.09)	62 (2.44)	62 (2.44)
Connection	2 m cable M8 connector	2 m cable M8 connector M12 connector	2 m cable M12 connector	2 m cable M12 connector	2 m cable M12 connector
Supply, DC	12–24 V, 12–48 V	12–24 V, 12–48 V	12–24 V, 12–48 V	12–24 V, 12–48 V	12–24 V, 12–48 V
Output	PNP or NPN	PNP or NPN	PNP or NPN	PNP or NPN	PNP or NPN
Function	NO or NC	NO or NC	NO or NC	NO or NC	NO or NC
Short case model	XS506B1***	XS508B1***	XS512B1***	XS518B1***	XS530B1***
Long case model	XS506BL***	XS508BL***	XS512BL***	XS518BL***	XS530BL***

Flush mountable, standard range  
1.5 to 10 mm (0.06 to 0.39 in.)

Metal

2-wire DC



Format	Ø 6.5 mm	Ø 8 mm	Ø 12 mm	Ø 18 mm	Ø 30 mm
Sensing dist., mm (in.)	1.5 (0.06)	1.5 (0.06)	2 (0.08)	5 (0.20)	10 (0.39)
Length Short Case	33 (1.30)	33 (1.30)	35 (1.38)	39 (1.54)	43 (1.69)
mm (in.) Long Case	–	51 (2.01)	53 (2.09)	62 (2.44)	62 (2.44)
Connection	2 m cable M12 connector	2 m cable M12 connector	2 m cable M12 connector	2 m cable M12 connector	2 m cable M12 connector
Supply, DC	12–24 V, 12–48 V	12–24 V, 12–48 V	12–24 V, 12–48 V	12–24 V, 12–48 V	12–24 V, 12–48 V
Function	NO or NC	NO or NC	NO or NC	NO or NC	NO or NC
Short case model	XS506BS***	XS508BS***	XS512BS***	XS518BS***	XS530BS***
Long case model	–	XS508B1***	XS512B1***	XS518B1***	XS530B1***

Flush mountable, increased range  
2.5 to 15 mm (0.10 to 0.59 in.)

Metal

3-wire DC



Format	Ø 6.5 mm	Ø 8 mm	Ø 12 mm	Ø 18 mm	Ø 30 mm
Sensing dist., mm (in.)	2.5 (0.10)	2.5 (0.10)	4 (0.16)	8 (0.31)	15 (0.59)
Length Short Case	33 (1.30)	33 (1.30)	35 (1.38)	39 (1.54)	43 (1.69)
mm (in.) Long Case	–	51 (2.01)	53 (2.09)	62 (2.44)	62 (2.44)
Connection	2 m cable M12 connector	2 m cable M12 connector	2 m cable M12 connector	2 m cable M12 connector	2 m cable M12 connector
Supply, DC	12–24 V, 12–48 V	12–24 V, 12–48 V	12–24 V, 12–48 V	12–24 V, 12–48 V	12–24 V, 12–48 V
Output	PNP or NPN	PNP or NPN	PNP or NPN	PNP or NPN	PNP or NPN
Function	NO or NC	NO or NC	NO or NC	NO or NC	NO or NC
Short case model	XS106B3•••	XS108B3•••	XS112B3•••	XS118B3•••	XS130B3•••
Long case model	–	XS608B1•••	XS612B1•••	XS618B1•••	XS630B1•••

Flush mountable, increased range  
2 to 15 mm (0.08 to 0.59 in.)

Metal

2-wire DC



Format	Ø 6.5 mm plain	Ø 8 mm	Ø 12 mm	Ø 18 mm	Ø 30 mm
Sensing dist., mm (in.)	2.5 (0.10)	2.5 (0.10)	4 (0.16)	8 (0.31)	15 (0.59)
Length Short case	33 (1.30)	33 (1.30)	35 (1.38)	39 (1.54)	43 (1.69)
mm (in.) Long Case	51 (2.01)	51 (2.01)	53 (2.09)	62 (2.44)	62 (2.44)
Connection	2 m cable M12 connector	2 m cable M8 connector M12 connector	2 m cable M12 connector	2 m cable M12 connector	2 m cable M12 connector
Supply, DC	12–24 V, 12–48 V	12–24 V, 12–48 V	12–24 V, 12–48 V	12–24 V, 12–48 V	12–24 V, 12–48 V
Function	NO or NC	NO or NC	NO or NC	NO or NC	NO or NC
Short case model	XS606B3•••	XS608B3•••	XS612B3•••	XS618B3•••	XS630B3•••
Long case model	XS606B1•••	XS608B1•••	XS612B1•••	XS618B1•••	XS630B1•••

## > Selection guide—continued

Flush mountable, standard range  
2 to 10 mm (0.08 to 0.39 in.)

Metal

2-wire AC or DC



Format	Ø 12 mm plain	Ø 18 mm	Ø 30 mm
Sensing dist., mm (in.)	2 (0.08)	5 (0.20)	10 (0.39)
Length Long Case mm (in.)	53 (2.09)	62 (2.44)	62 (2.44)
Connection	2 m cable 1/2" -20 UNF connector	2 m cable 1/2" -20 UNF connector	2 m cable 1/2" -20 UNF connector
Supply, AC or DC	24–240	24–240	24–240
Function	NO or NC	NO or NC	NO or NC
Long case model	XS512B1M•••	XS518B1M•••	XS530B1M•••

Non-flush mountable, increased range  
7 to 22 mm (0.28 to 0.87 in.)

Metal

3-wire DC



Format	Ø 12 mm plain	Ø 18 mm	Ø 30 mm
Sensing dist., mm (in.)	7 (0.28)	12 (0.47)	22 (0.87)
Length Long Case mm (in.)	55 (2.17)	60 (2.36)	63 (2.48)
Connection	2 m cable M12 connector	2 m cable M12 connector	2 m cable M12 connector
Output	PNP or NPN	PNP or NPN	PNP or NPN
Function	NO or NC	NO or NC	NO or NC
Long case model	XS612B4•••	XS618B4•••	XS630B4•••



Flush mountable, increased range  
4 to 15 mm (0.16 to 0.59 in.)

Metal

2-wire AC or DC



Format	Ø 12 mm plain	Ø 18 mm	Ø 30 mm
Sensing dist., mm (in.)	4 (0.16)	8 (0.31)	15 (0.59)
Length Long Case mm (in.)	53 (2.09)	62 (2.44)	62 (2.44)
Connection	2 m cable 1/2" -20 UNF connector	2 m cable 1/2" -20 UNF connector	2 m cable 1/2" -20 UNF connector
Supply, AC or DC	24-240	24-240	24-240
Function	NO or NC	NO or NC	NO or NC
Long case model	XS612B1M***	XS618B1M***	XS630B1M***

Non-flush mountable, increased range  
12 to 22 mm (0.47 to 0.87 in.)

Metal

2-wire AC or DC



Format	Ø 18 mm	Ø 30 mm
Sensing dist., mm (in.)	12 (0.47)	22 (0.87)
Length Long case, mm (in.)	60 (2.36)	63 (2.48)
Connection	2 m cable M8 connector M12 connector	2 m cable M12 connector
Supply	3-wire 12-24 V	3-wire 12-24 V
Output	PNP or NPN	PNP or NPN
Function	NO or NC	NO or NC
Long case model	XS618B4M***	XS630B4M***

# OsiSense® Inductive proximity sensors

General purpose

Cylindrical, standard range, flush mountable

Three-wire DC, solid-state output



XS506B1●●L2

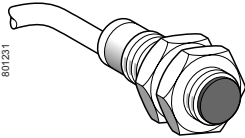

XS508B1●●L2

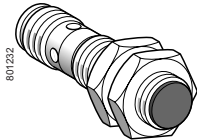

XS512B1●●M12

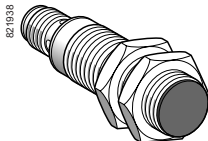

XS518B1●●M12



XS518B1●●L2

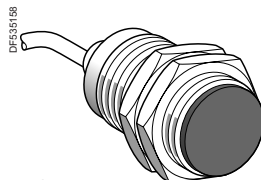

XS530B1●●L2

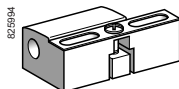

XSZB1●●

## Sensors, 3-wire 12–24 V $\bar{\text{DC}}$ , short case model

Sensing dist. Sn, mm (in.)	Function	Output	Connection	Catalog Number	Weight (kg)	Weight (lb)
<b>Ø 6.5, plain</b>						
1.5 (0.06)	NO	PNP	Pre-cabled (1)	XS506B1PAL2	0.035	(0.08)
			M8 connector	XS506B1PAM8	0.025	(0.06)
			M12 connector	XS506B1PAM12	0.025	(0.06)
	NPN	PNP	Pre-cabled (1)	XS506B1NAL2	0.035	(0.08)
			M8 connector	XS506B1NAM8	0.025	(0.06)
			M12 connector	XS506B1NAM12	0.025	(0.06)
	NC	PNP	Pre-cabled (1)	XS506B1PBL2	0.035	(0.08)
			M8 connector	XS506B1PBM8	0.025	(0.06)
			M12 connector	XS506B1PBM12	0.025	(0.06)
	NPN	PNP	Pre-cabled (1)	XS506B1NBL2	0.035	(0.08)
			M8 connector	XS506B1NBM8	0.025	(0.06)
			M12 connector	XS506B1NBM12	0.025	(0.06)
<b>Ø 8, threaded M8 x 1</b>						
1.5 (0.06)	NO	PNP	Pre-cabled (1)	XS508B1PAL2	0.035	(0.08)
			M8 connector	XS508B1PAM8	0.025	(0.06)
			M12 connector	XS508B1PAM12	0.025	(0.06)
	NPN	PNP	Pre-cabled (1)	XS508B1NAL2	0.035	(0.08)
			M8 connector	XS508B1NAM8	0.025	(0.06)
			M12 connector	XS508B1NAM12	0.025	(0.06)
	NC	PNP	Pre-cabled (1)	XS508B1PBL2	0.035	(0.08)
			M8 connector	XS508B1PBM8	0.025	(0.06)
			M12 connector	XS508B1PBM12	0.025	(0.06)
	NPN	PNP	Pre-cabled (1)	XS508B1NBL2	0.035	(0.08)
			M8 connector	XS508B1NBM8	0.025	(0.06)
			M12 connector	XS508B1NBM12	0.025	(0.06)
<b>Ø 12, threaded M12 x 1</b>						
2 (0.08)	NO	PNP	Pre-cabled (1)	XS512B1PAL2	0.075	(0.17)
			M12 connector	XS512B1PAM12	0.035	(0.08)
			M12 connector	XS512B1NAM12	0.035	(0.08)
	NPN	PNP	Pre-cabled (1)	XS512B1NAL2	0.075	(0.17)
			M12 connector	XS512B1NAM12	0.035	(0.08)
			M12 connector	XS512B1NAM12	0.035	(0.08)
	NC	PNP	Pre-cabled (1)	XS512B1PBL2	0.075	(0.17)
			M12 connector	XS512B1PBM12	0.035	(0.08)
			M12 connector	XS512B1PBM12	0.035	(0.08)
	NPN	PNP	Pre-cabled (1)	XS512B1NBL2	0.075	(0.17)
			M12 connector	XS512B1NBM12	0.035	(0.08)
			M12 connector	XS512B1NBM12	0.035	(0.08)
<b>Ø 18, threaded M18 x 1</b>						
5 (0.20)	NO	PNP	Pre-cabled (1)	XS518B1PAL2	0.120	(0.26)
			M12 connector	XS518B1PAM12	0.060	(0.13)
			M12 connector	XS518B1NAM12	0.060	(0.13)
	NPN	PNP	Pre-cabled (1)	XS518B1NAL2	0.120	(0.26)
			M12 connector	XS518B1NAM12	0.060	(0.13)
			M12 connector	XS518B1NAM12	0.060	(0.13)
	NC	PNP	Pre-cabled (1)	XS518B1PBL2	0.120	(0.26)
			M12 connector	XS518B1PBM12	0.060	(0.13)
			M12 connector	XS518B1PBM12	0.060	(0.13)
	NPN	PNP	Pre-cabled (1)	XS518B1NBL2	0.120	(0.26)
			M12 connector	XS518B1NBM12	0.060	(0.13)
			M12 connector	XS518B1NBM12	0.060	(0.13)
<b>Ø 30, threaded M30 x 1.5</b>						
10 (0.39)	NO	PNP	Pre-cabled (1)	XS530B1PAL2	0.205	(0.45)
			M12 connector	XS530B1PAM12	0.145	(0.32)
			M12 connector	XS530B1NAM12	0.145	(0.32)
	NPN	PNP	Pre-cabled (1)	XS530B1NAL2	0.205	(0.45)
			M12 connector	XS530B1NAM12	0.145	(0.32)
			M12 connector	XS530B1NAM12	0.145	(0.32)
	NC	PNP	Pre-cabled (1)	XS530B1PBL2	0.205	(0.45)
			M12 connector	XS530B1PBM12	0.145	(0.32)
			M12 connector	XS530B1PBM12	0.145	(0.32)
	NPN	PNP	Pre-cabled (1)	XS530B1NBL2	0.205	(0.45)
			M12 connector	XS530B1NBM12	0.145	(0.32)
			M12 connector	XS530B1NBM12	0.145	(0.32)
<b>Accessories</b>						
Description	For use with sensors	Catalog Number	Weight (kg)	Weight (lb)		
Mounting clamps	Ø 6.5 (plain)	XSZB165	0.005	(0.01)		
	Ø 8	XSZB108	0.006	(0.01)		
	Ø 12	XSZB112	0.006	(0.01)		
	Ø 18	XSZB118	0.010	(0.02)		
	Ø 30	XSZB130	0.020	(0.02)		

(1) For a 5 m long cable replace L2 with L5; for a 10 m cable replace L2 with L10.  
Example: XS508B1PAL2 becomes XS508B1PAL5 with a 5 m cable.

# OsiSense® Inductive proximity sensors

General purpose

Cylindrical, standard range, flush mountable

Three-wire DC, solid-state output

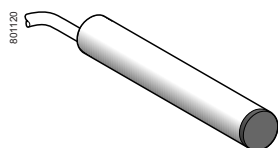

XS506BL●●L2

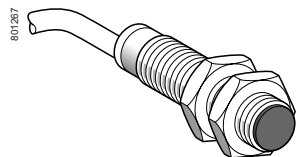

XS5●●BL●●L2

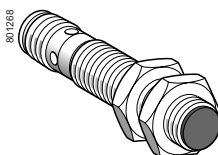

XS5●●BL●●M12

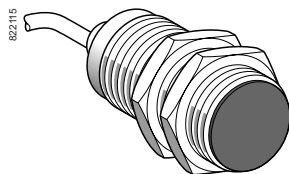

XS5 30BL●●L2

## Sensors, 3-wire 12–48 V $\overline{\text{DC}}$ , long case model

Sensing dist. Sn, mm (in.)	Function	Output	Connection	Catalog Number	Weight kg	Weight (lb)
<b>Ø 6.5, plain</b>						
1.5 (0.06)	NO	PNP	Pre-cabled (1)	XS506BLPAL2	0.035	(0.08)
		NPN	Pre-cabled (1)	XS506BLNAL2	0.035	(0.08)

## Ø 8, threaded M8 x 1

1.5 (0.06)	NO	PNP	Pre-cabled (1)	XS508BLPAL2	0.035	(0.08)
			M12 connector	XS508BLPAM12	0.025	(0.06)
	NPN	Pre-cabled (1)	XS508BLNAL2	0.035	(0.08)	
		M12 connector	XS508BLNAM12	0.025	(0.06)	
	NC	PNP	Pre-cabled (1)	XS508BLPBL2	0.035	(0.08)
			M12 connector	XS508BLPBM12	0.025	(0.06)
NPN	Pre-cabled (1)	XS508BLNBL2	0.035	(0.08)		
	M12 connector	XS508BLNBM12	0.025	(0.06)		

## Ø 12, threaded M12 x 1

2 (0.08)	NO	PNP	Pre-cabled (1)	XS512BLPAL2	0.075	(0.17)
			M12 connector	XS512BLPAM12	0.035	(0.08)
	NPN	Pre-cabled (1)	XS512BLNAL2	0.075	(0.17)	
		M12 connector	XS512BLNAM12	0.035	(0.08)	
	NC	PNP	Pre-cabled (1)	XS512BLPBL2	0.075	(0.17)
			M12 connector	XS512BLPBM12	0.035	(0.08)
NPN	Pre-cabled (1)	XS512BLNBL2	0.075	(0.17)		
	M12 connector	XS512BLNBM12	0.035	(0.08)		

## Ø 18, threaded M18 x 1

5 (0.20)	NO	PNP	Pre-cabled (1)	XS518BLPAL2	0.120	(0.26)
			M12 connector	XS518BLPAM12	0.060	(0.13)
	NPN	Pre-cabled (1)	XS518BLNAL2	0.120	(0.26)	
		M12 connector	XS518BLNAM12	0.060	(0.13)	
	NC	PNP	Pre-cabled (1)	XS518BLPBL2	0.120	(0.26)
			M12 connector	XS518BLPBM12	0.060	(0.13)
NPN	Pre-cabled (1)	XS518BLNBL2	0.120	(0.26)		
	M12 connector	XS518BLNBM12	0.060	(0.13)		

## Ø 30, threaded M30 x 1.5

10 (0.39)	NO	PNP	Pre-cabled (1)	XS530BLPAL2	0.205	(0.45)
			M12 connector	XS530BLPAM12	0.145	(0.32)
	NPN	Pre-cabled (1)	XS530BLNAL2	0.205	(0.45)	
		M12 connector	XS530BLNAM12	0.145	(0.32)	
	NC	PNP	Pre-cabled (1)	XS530BLPBL2	0.205	(0.45)
			M12 connector	XS530BLPBM12	0.145	(0.32)
NPN	Pre-cabled (1)	XS530BLNBL2	0.205	(0.45)		
	M12 connector	XS530BLNBM12	0.145	(0.32)		

## Accessories

Description	For use with sensors	Catalog Number	Weight kg	Weight (lb)
Mounting clamps	Ø 6.5 (plain)	XSZ B165	0.005	(0.01)
	Ø 8	XSZB108	0.006	(0.01)
	Ø 12	XSZB112	0.006	(0.01)
	Ø 18	XSZB118	0.010	(0.02)
	Ø 30	XSZB130	0.020	(0.04)

(1) For a 5 m cable replace L2 with L5; for a 10 m cable replace L2 with L10.  
Example: XS508BLPAL2 becomes XS508BLPAL5 with a 5 m cable.

# OsiSense® Inductive proximity sensors

General purpose

Cylindrical, standard range, flush mountable

Three-wire DC, solid-state output

Specifications				
Sensor type			XS5●●B1●●M8, XS5●●B1●●M12 XS5●●BL●●M8, XS5●●BL●●M12	XS5●●B1●●L2 XS5●●BL●●L2
Product certifications				UL, CSA, CE
Connection	Connector		M8 on Ø 6.5 and Ø 8, M12 on Ø 8, Ø 12, Ø 18 and Ø 30	–
	Pre-cabled		–	Length 2 m
Operating zone	Ø 6.5 and Ø 8	mm	0–1.2 (0–0.05 in.)	
	Ø 12	mm	0–1.6 (0–0.06 in.)	
	Ø 18	mm	0–4 (0–0.28 in.)	
	Ø 30	mm	0–8 (0–0.31 in.)	
Differential travel		%	1–15 of effective sensing distance (Sr)	
Degree of protection	Conforming to IEC 60529		IP 65 and IP 67	IP 65 and IP 68, double insulation ☐ (except Ø 6.5 and Ø 8: IP 67)
	Conforming to DIN 40050		IP 69K for Ø 12 to Ø 30	
Storage temperature		°C	-40 to +85 (-40 to +185 °F)	
Operating temperature		°C	-25 to +70 (-13 to +158 °F)	
Materials	Case		Nickel plated brass (except XS5 06 and XS5 08BL: stainless steel, grade 303)	
	Sensing face		PPS	
	Cable		–	PvR 3 x 0.34 mm <sup>2</sup> (22 AWG) except <b>XS506</b> and <b>XS508</b> : 3 x 0.11 mm <sup>2</sup> (27 AWG)
Vibration resistance	Conforming to IEC 60068-2-6		25 gn, amplitude ± 2 mm (f = 10 to 50 Hz)	
Shock resistance	Conforming to IEC 60068-2-27		50 gn, duration 11 ms	
Output state indication			Yellow LED: 4 viewing ports at 90°	Yellow LED: circular
Rated supply voltage		V	--- 12–48 for XS5●●BL, --- 12–24 for XS5●●B1 with protection against reverse polarity	
Voltage limits (including ripple)		V	--- 10–58 for XS5●●BL, --- 10–36 for XS5●●B1	
Switching capacity		mA	≤ 200 with overload and short-circuit protection	
Voltage drop, closed state		V	≤ 2	
Current consumption, no-load		mA	≤ 10	
Maximum switching frequency	XS506, XS508, XS512	Hz	5000	
	XS518	Hz	2000	
	XS530	Hz	1000	
Delays	First-up	ms	≤ 10	
	Response	ms	≤ 0.1 : <b>XS506</b> , <b>XS508</b> and <b>XS512</b>	
			≤ 0.15 : <b>XS518</b>	
≤ 0.3 : <b>XS530</b>				
Recovery	ms	≤ 0.1 : <b>XS506</b> , <b>XS508</b> and <b>XS512</b>		
		≤ 0.35 : <b>XS518</b>		
		≤ 0.7 : <b>XS530</b>		

# OsiSense® Inductive proximity sensors

General purpose  
Cylindrical, standard range, flush mountable  
Three-wire DC, solid-state output

## Wiring diagrams

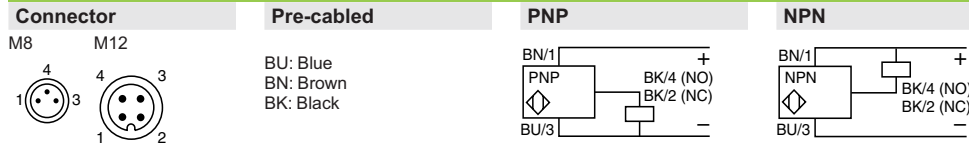

For M8 connector, NO and NC outputs on terminal 4

## Setup

### Minimum mounting distances (mm)

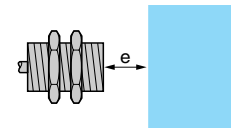
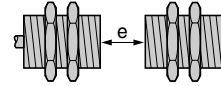
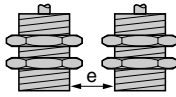

Sensors	Side by side	Face to face	Facing a metal object
Ø 6.5	e ≥ 3	e ≥ 18	e ≥ 4.5
Ø 8	e ≥ 3	e ≥ 18	e ≥ 4.5
Ø 12	e ≥ 4	e ≥ 24	e ≥ 6
Ø 18	e ≥ 10	e ≥ 60	e ≥ 15
Ø 30	e ≥ 20	e ≥ 120	e ≥ 30

## Dimensions (mm)

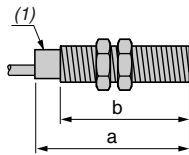

(1) LED

Sensors		Pre-cabled (mm)		M8 connector (mm)		M12 connector (mm)	
		a	b	a	b	a	b
<b>Short case model</b>							
Ø 6.5	XS506B1	33	–	42	–	45	–
Ø 8	XS508B1	33	25	42	26	45	24
Ø 12	XS512B1	35	25	–	–	50	30
Ø 18	XS518B1	39	28	–	–	50	28
Ø 30	XS530B1	43	32	–	–	55	32
<b>Long case model</b>							
Ø 6.5	XS506BL	51	–	–	–	–	–
Ø 8	XS508BL	51	42	62	40	–	–
Ø 12	XS512BL	53	42	62	42	–	–
Ø 18	XS518BL	62	52	74	52	–	–
Ø 30	XS530BL	62	52	74	52	–	–

# OsiSense® Inductive proximity sensors

General purpose

Cylindrical, standard range, flush mountable

Two-wire DC

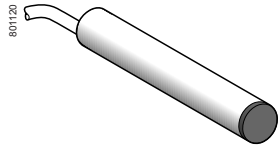

XS506BS●●L2



XS512BS●●L2



XS5●●BS●●M12

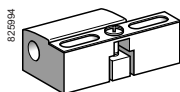

XSZB1●●

## Sensors, 2-wire 12–24 V $\bar{\text{DC}}$ , short case model

Sensing dist. Sn, mm (in.)	Function	Connection	Catalog Number	Weight kg (lb)
<b>Ø 6.5, plain</b>				
1.5 (0.06)	NO terminals 1 & 4 (2)	Pre-cabled (1)	<b>XS506BSCAL2</b>	0.035 (0.08)
		Remote M12 connector	<b>XS506BSCAL01M12</b>	0.050 (0.11)
	NC	Pre-cabled (1)	<b>XS506BSCBL2</b>	0.035 (0.08)
<b>Ø 8, threaded M8 x 1</b>				
1.5 (0.06)	NO terminals 1 & 4 (2)	Pre-cabled (1)	<b>XS508BSCAL2</b>	0.035 (0.08)
		Remote M12 connector	<b>XS508BSCAL01M12</b>	0.050 (0.11)
		Remote M12 connector	<b>XS508BSCAL08M12</b>	0.050 (0.11)
	NC	Pre-cabled (1)	<b>XS508BSCBL2</b>	0.035 (0.08)
		Remote M12 connector	<b>XS508BSCBL01M12</b>	0.050 (0.11)
<b>Ø 12, threaded M12 x 1</b>				
2 (0.08)	NO terminals 1 & 4 (2)	Pre-cabled (1)	<b>XS512BSDAL2</b>	0.075 (0.17)
		M12 connector	<b>XS512BSDAM12</b>	0.035 (0.08)
	NO terminals 1 & 4 (2)	M12 connector	<b>XS512BSCAM12</b>	0.035 (0.08)
		Remote M12 connector	<b>XS512BSCAL08M12</b>	0.060 (0.13)
	NC	Pre-cabled (1)	<b>XS512BSDBL2</b>	0.075 (0.17)
	M12 connector	<b>XS512BSDBM12</b>	0.035 (0.08)	
<b>Ø 18, threaded M18 x 1</b>				
5 (0.20)	NO terminals 1 & 4 (2)	Pre-cabled (1)	<b>XS518BSDAL2</b>	0.120 (0.26)
		M12 connector	<b>XS518BSDAM12</b>	0.060 (0.13)
	NO terminals 1 & 4 (2)	M12 connector	<b>XS518BSCAM12</b>	0.060 (0.13)
		Remote M12 connector	<b>XS518BSCAL08M12</b>	0.085 (0.19)
	NC	Pre-cabled (1)	<b>XS518BSDBL2</b>	0.120 (0.26)
	M12 connector	<b>XS518BSDBM12</b>	0.060 (0.13)	
<b>Ø 30, threaded M30 x 1.5</b>				
10 (0.39)	NO terminals 1 & 4 (2)	Pre-cabled (1)	<b>XS530BSDAL2</b>	0.205 (0.45)
		M12 connector	<b>XS530BSDAM12</b>	0.145 (0.32)
	NO terminals 1 & 4 (2)	M12 connector	<b>XS530BSCAM12</b>	0.145 (0.32)
		Remote M12 connector	<b>XS530BSCAL08M12</b>	0.170 (0.37)
	NC	Pre-cabled (1)	<b>XS530BSDBL2</b>	0.205 (0.45)
	M12 connector	<b>XS530BSDBM12</b>	0.145 (0.32)	

## Accessories

Description	For use with sensors	Catalog Number	Weight kg (lb)
Mounting clamps	Ø 6.5 (plain)	<b>XSZ B165</b>	0.005 (0.01)
	Ø 8	<b>XSZB108</b>	0.006 (0.01)
	Ø 12	<b>XSZB112</b>	0.006 (0.01)
	Ø 18	<b>XSZB118</b>	0.010 (0.02)
	Ø 30	<b>XSZB130</b>	0.020 (0.04)

(1) For a 5 m long cable replace L2 with L5; for a 10 m cable replace L2 with L10.

Example: XS508BSCAL2 becomes **XS508BSCAL5** with a 5 m cable.

(2) The NO output is connected to terminals 1 and 4 of the M12 connector.

# OsiSense® Inductive proximity sensors

General purpose  
Cylindrical, standard range, flush mountable  
Two-wire DC



XS5●●B1●●L2



XS5●●B1●●M12



XS5●●B1●●L01B (2)



XS5●●B1●●L01C



XS5●●B1●●L01G



XSZB1●●

## Sensors, 2-wire 12–48 V $\overline{\text{DC}}$ , long case model

Sensing distance Sn, mm (in.)	Function	Connection	Catalog Number	Weight kg (lb)
<b>Ø 8, threaded M8 x 1</b>				
1.5 (0.06)	NO	Pre-cabled (1)	<b>XS508B1DAL2</b>	0.035 (0.08)
		Remote M12 connector	<b>XS508B1DAL08M12</b>	0.050 (0.11)
	NO	M12 connector	<b>XS508B1DAM12</b>	0.025 (0.06)
		Remote M12 connector	<b>XS508B1CAL08M12</b>	0.050 (0.11)
	NC	Pre-cabled (1)	<b>XS508B1DBL2</b>	0.035 (0.08)
		M12 connector	<b>XS508B1DBM12</b>	0.025 (0.06)
<b>Ø 12, threaded M12 x 1</b>				
2 (0.08)	NO	Pre-cabled (1)	<b>XS512B1DAL2</b>	0.075 (0.17)
		Remote 7/8" connector	<b>XS512B1DAL08U78</b>	0.050 (0.11)
	NO	M12 connector	<b>XS512B1DAM12</b>	0.035 (0.08)
		Remote M12 connector	<b>XS512B1CAL08M12</b>	0.060 (0.13)
	NC	Pre-cabled (1)	<b>XS512B1DBL2</b>	0.075 (0.17)
		M12 connector	<b>XS512B1DBM12</b>	0.035 (0.08)
	NC	Remote M12 connector	<b>XS512B1DBL08M12</b>	0.060 (0.13)
<b>Ø 18, threaded M18 x 1</b>				
5 (0.20)	NO	Pre-cabled (1)	<b>XS518B1DAL2</b>	0.120 (0.26)
		Low temperature version (-40 °C)	<b>XS518B1DAL2TF (4)</b>	0.120 (0.26)
	NO	Remote screw terminal connector (2)	<b>XS518B1DAL01B</b>	0.085 (0.19)
		Remote DIN 43650A connector	<b>XS518B1DAL01C</b>	0.085 (0.19)
	NO	Remote M18 connector	<b>XS518B1DAL01G</b>	0.085 (0.19)
		M12 connector	<b>XS518B1DAM12</b>	0.060 (0.13)
	NO	Remote M12 connector	<b>XS518B1CAL08M12</b>	0.060 (0.13)
		Remote M12 connector	<b>XS518B1CAL08M12</b>	0.085 (0.19)
	NC	Pre-cabled (1)	<b>XS518B1DBL2</b>	0.120 (0.26)
		M12 connector	<b>XS518B1DBM12</b>	0.060 (0.13)
	NC	Remote M12 connector	<b>XS518B1DBL08M12</b>	0.085 (0.19)
		Remote screw terminal connector (2)	<b>XS518B1DBL01B</b>	0.120 (0.26)
<b>Ø 30, threaded M30 x 1.5</b>				
10 (0.39)	NO	Pre-cabled (1)	<b>XS530B1DAL2</b>	0.205 (0.45)
		Low temperature version (-40 °C)	<b>XS530B1DAL2TF (4)</b>	0.120 (0.26)
	NO	M12 connector	<b>XS530B1DAM12</b>	0.145 (0.32)
		Remote screw terminal connector (2)	<b>XS530B1DAL01B</b>	0.205 (0.45)
	NO	Remote DIN 43650A connector	<b>XS530B1DAL01C</b>	0.205 (0.45)
		Remote M18 connector	<b>XS530B1DAL01G</b>	0.205 (0.45)
	NO	M12 connector	<b>XS530B1CAM12</b>	0.145 (0.32)
		Remote M12 connector	<b>XS530B1CAL08M12</b>	0.170 (0.37)
	NC	Pre-cabled (1)	<b>XS530B1DBL2</b>	0.205 (0.45)
		M12 connector	<b>XS530B1DBM12</b>	0.145 (0.32)
	NC	Remote screw terminal connector (2)	<b>XS530B1DBL01B</b>	0.205 (0.37)
<b>Accessories</b>				
Description	For use with sensors	Catalog Number	Weight kg (lb)	
Mounting clamps	Ø 8	<b>XSZB108</b>	0.006 (0.01)	
	Ø 12	<b>XSZB112</b>	0.006 (0.01)	
	Ø 18	<b>XSZB118</b>	0.010 (0.02)	
	Ø 30	<b>XSZB130</b>	0.020 (0.04)	

(1) For a 5 m cable replace L2 with L5; for a 10 m long cable replace L2 with L10.  
Example: XS508B1DAL2 becomes XS508B1DAL5 with a 5 m long cable.

(2) Protective cable gland included with remote screw terminal connector.

(3) The NO output is connected to terminals 1 and 4 of the M12 connector.

(4) For a 5 m long cable replace L2 with L5.

Example: XS518B1DAL2TF becomes XS518B1DAL5TF with a 5 m long cable.

For PUR cable, replace the letter L in the reference with P.

Example: XS518B1DAL2TF becomes XS518B1DAP2TF with PUR cable.

For a 5 m long PUR cable replace P2 with P5.

Example: XS518B1DAP2TF becomes XS518B1DAP5TF with a 5 m long PUR cable.

# OsiSense® Inductive proximity sensors

General purpose

Cylindrical, standard range, flush mountable

Two-wire DC

Specifications			
Sensor type		XS5●●B1●●M12, XS5●●BS●●M12	XS5●●B1D●L2, XS5●●BSD●L2
Product certifications		UL, CSA, CE	
Connection	Connector	M12	–
	Pre-cabled	–	Length 2 m
	Remote connector	Remote M12 connector (L01M12), screw terminal (L01B), DIN 43650A (L01C) and remote M18 connector (L01G) on 0.15 m flying lead. Remote M12 (L08M12) or 7/8" (L08U78) connector on 0.80 m flying lead.	
Operating zone	Ø 6.5	mm	0–1.2 (0–0.05 in.)
	Ø 8	mm	0–1.2 (0–0.05 in.)
	Ø 12	mm	0–1.6 (0–0.06 in.)
	Ø 18	mm	0–4 (0–0.16 in.)
	Ø 30	mm	0–8 (0–0.31 in.)
Differential travel		%	1–15 of effective sensing distance (Sr)
Degree of protection		Conforming to IEC 60529	IP 65 and IP 67 IP 65 and ☐ IP 68, double insulation (except Ø 6.5 and Ø 8: IP 67)
Storage temperature		°C	-40 to +85 (-40 to +185 °F)
Operating temperature		°C	-25 to +70 (-13 to +158 °F) ; TF products: -40 to +70 (-40 to +158 °F)
Materials	Case	Nickel plated brass (except XS506 and XS508B1: stainless steel, grade 303)	
	Sensing face	PPS	
	Cable	–	PvR 2 x 0.34 mm <sup>2</sup> (22 AWG) except XS506 and XS508: 2 x 0.11 mm <sup>2</sup> (27 AWG) PUR available (1)
Vibration resistance		Conforming to IEC 60068-2-6	25 gn, amplitude ± 2 mm (f = 10 to 55 Hz)
Shock resistance		Conforming to IEC 60068-2-27	50 gn, duration 11 ms
Output state indication			Yellow LED: 4 viewing ports at 90° Yellow LED: circular
Rated supply voltage		V	--- 12–48 non-polarized for XS5●●B1D, --- 12–24 non-polarized for XS5●●BS (except Ø 6.5 and Ø 8 short case models, which are polarized) with protection against reverse polarity
Voltage limits (including ripple)		V	--- 10–58 for XS5●●B1D, --- 10–36 for XS5●●BS
Switching capacity		mA	1.5–100 with overload and short-circuit protection
Voltage drop, closed state		V	≤ 4
Residual current, open state		mA	≤ 0.5
Maximum switching frequency	XS506, XS508, XS512	Hz	4000
	XS518	Hz	3000
	XS530	Hz	2000
Delays	First-up	ms	≤ 10
	Response	ms	≤ 0.2 : XS506, XS508 and XS512 ≤ 0.15 : XS518 ≤ 0.3 : XS530
		ms	≤ 0.2 (except XS530B1: ≤ 0.3)
		ms	≤ 0.2 (except XS530B1: ≤ 0.3)

(1) For PUR cable, replace the letter L in the reference with P. Example: XS506BSDAL2 becomes XS5 06BSDAP2 with PUR cable.



# OsiSense® Inductive proximity sensors

General purpose  
Cylindrical, standard range, flush mountable  
Two-wire DC

## Wiring diagrams

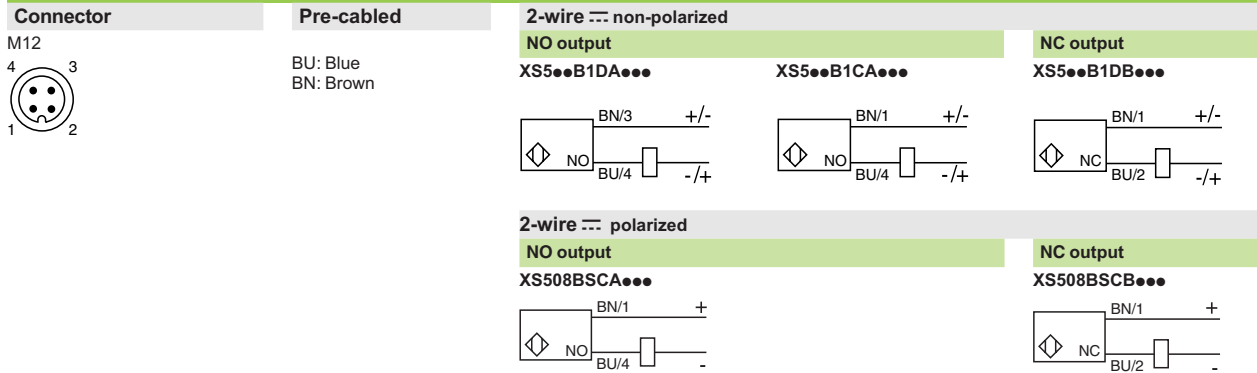

## Remote connectors LO1B, LO1C, LO1G

### Screw terminal (LO1B)

The terminal numbering differs according to the version ( $\overline{\overline{\text{---}}}$  2-wire,  $\overline{\overline{\text{---}}}$  3-wire,  $\approx$  2-wire).

### DIN 43650 A (LO1C)

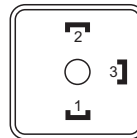

### M18 (LO1G)

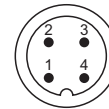

The NO or NC outputs are connected to terminal 2.

## Setup

### Minimum mounting distances (mm)

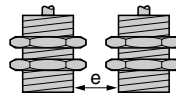

#### Side by side

Ø 6.5	$e \geq 3$
Ø 8	$e \geq 3$
Ø 12	$e \geq 4$
Ø 18	$e \geq 10$
Ø 30	$e \geq 20$

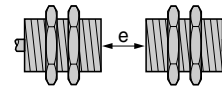

#### Face to face

$e \geq 18$
$e \geq 18$
$e \geq 24$
$e \geq 60$
$e \geq 120$

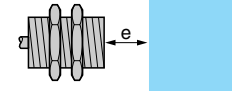

#### Facing a metal object

$e \geq 4.5$
$e \geq 4.5$
$e \geq 6$
$e \geq 15$
$e \geq 30$

## Dimensions (mm)

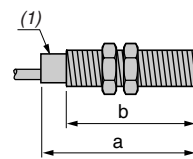

(1) LED

Sensors		Pre-cabled (mm)		M8 connector (mm)		M12 connector (mm)	
Short case model		a	b	a	b	a	b
Ø 6.5	XS506BS	33	—	42	—	45	—
Ø 8	XS508BS	33	25	42	26	45	24
Ø 12	XS512BS	35	25	—	—	50	30
Ø 18	XS518BS	39	28	—	—	50	28
Ø 30	XS530BS	43	32	—	—	55	32
Sensors		Pre-cabled (mm)		M12 connector (mm)			
Long case model		a	b	a	b		
Ø 8	XS508B1	51	42	62	40		
Ø 12	XS512B1	53	42	62	42		
Ø 18	XS518B1	62	52	74	52		
Ø 30	XS530B1	62	52	74	52		

# OsiSense® Inductive proximity sensors

General purpose

Cylindrical, standard range, flush mountable

Two-wire AC or DC <sup>(1)</sup>



XS5●●B1M●L2

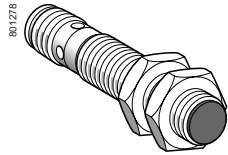

XS5●●B1M●U20

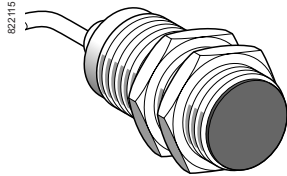

XS530B1●●L2



XSZB1●●

### Sensors, 2-wire 24–240 V $\sphericalangle$ , long case model

#### Ø 12, threaded M12 x 1

Sensing distance Sn, mm (in.)	Function	Connection	Catalog Number	Weight kg (lb)
2 (0.08)	NO	Pre-cabled <sup>(1)</sup>	<b>XS512B1MAL2</b>	0.075 (0.17)
		1/2"-20UNF connector	<b>XS512B1MAU20</b>	0.025 (0.06)
	NC	Pre-cabled <sup>(1)</sup>	<b>XS512B1MBL2</b>	0.075 (0.17)
		1/2"-20UNF connector	<b>XS512B1MBU20</b>	0.025 (0.06)

#### Ø 18, threaded M18 x 1

Sensing distance Sn, mm (in.)	Function	Connection	Catalog Number	Weight kg (lb)
5 (0.20)	NO	Pre-cabled <sup>(1)</sup>	<b>XS518B1MAL2</b>	0.100 (0.22)
		1/2"-20UNF connector	<b>XS518B1MAU20</b>	0.060 (0.13)
	NC	Pre-cabled <sup>(1)</sup>	<b>XS518B1MBL2</b>	0.100 (0.22)
		1/2"-20UNF connector	<b>XS518B1MBU20</b>	0.060 (0.13)

#### Ø 30, threaded M30 x 1.5

Sensing distance Sn, mm (in.)	Function	Connection	Catalog Number	Weight kg (lb)
10 (0.39)	NO	Pre-cabled <sup>(1)</sup>	<b>XS530B1MAL2</b>	0.205 (0.45)
		1/2"-20UNF connector	<b>XS530B1MAU20</b>	0.145 (0.32)
	NC	Pre-cabled <sup>(1)</sup>	<b>XS530B1MBL2</b>	0.205 (0.45)
		1/2"-20UNF connector	<b>XS530B1MBU20</b>	0.145 (0.32)

### Accessories

Description	For use with sensors	Catalog Number	Weight kg (lb)
Mounting clamps	Ø 12	<b>XSZB112</b>	0.006 (0.01)
	Ø 18	<b>XSZB118</b>	0.010 (0.02)
	Ø 30	<b>XSZB130</b>	0.020 (0.04)

<sup>(1)</sup> For a 5 m long cable replace L2 with L5; for a 10 m cable replace L2 with L10.

Example: XS512B1MAL2 becomes **XS512B1MAL5** with a 5 m cable.

# OsiSense® Inductive proximity sensors

General purpose  
Cylindrical, standard range, flush mountable  
Two-wire AC or DC

Specifications					
Sensor type		XS5●●B1M●U20		XS5●●B1M●L2	
Product certifications		UL, CSA, CE			
Connection	Connector	1/2"-20UNF		-	
	Pre-cabled	-		Length 2 m	
Operating zone	Ø 12	mm	0-1.6 (0-0.05 in.)		
	Ø 18	mm	0-4 (0-0.16 in.)		
	Ø 30	mm	0-8 (0-0.31 in.)		
Differential travel		%	1-15 of effective sensing distance (Sr)		
Degree of protection	Conforming to IEC 60529	IP 65 and IP 67		IP 65 and IP 68, double insulation ☐	
	Conforming to DIN 40050	IP 69K			
Storage temperature		°C	-40 to +85 (-40 to +185 °F)		
Operating temperature		°C	-25 to +70 (-13 to +158 °F)		
Materials	Case	Nickel plated brass			
	Sensing face	PPS			
	Cable	-		PvR 2 x 0.34 mm <sup>2</sup> (22 AWG)	
Vibration resistance	Conforming to IEC 60068-2-6	25 gn, amplitude ± 2 mm (f = 10 to 55 Hz)			
Shock resistance	Conforming to IEC 60068-2-27	50 gn, duration 11 ms			
Output state indication		Yellow LED: 4 viewing ports at 90°		Yellow LED: circular	
Rated supply voltage		V	~ or --- 24-240 (~ 50/60 Hz)		
Voltage limits (including ripple)		V	~ or --- 20-264		
Switching capacity	XS512B1M●●●	mA	5-200 (1)		
	XS518B1M●●●, XS530B1M●●●	mA	~ 5-300 or --- 5-200 (1)		
Voltage drop, closed state		V	≤ 5.5		
Residual current, open state		mA	≤ 0.8		
Maximum switching frequency	XS512B1●●●, XS518B1M●●●	Hz	~ 25 or --- 1000		
	XS530B1M●●●	Hz	~ 25 or --- 500		
Delays	First-up	ms	≤ 20 XS512B1M●●●, ≤ 25 XS518B1M●●● and XS530B1M●●●		
	Response	ms	≤ 0.5		
	Recovery	ms	≤ 0.2 XS512B1M●●●, ≤ 0.5 XS518B1M●●●, ≤ 2 XS530B1M●●●		

(1) A 0.4 A "fast-acting" fuse must be connected in series with the load.

### Wiring diagrams

Connector	Pre-cabled	2-wire ~ or ---
1/2"-20UNF	BU: Blue BN: Brown	<b>NO or NC output</b>
		±: on connector models only

### Setup

Minimum mounting distances (mm)

Sensor	Side by side	Face to face	Facing a metal object
Ø 12	e ≥ 8	e ≥ 48	e ≥ 12
Ø 18	e ≥ 16	e ≥ 100	e ≥ 25
Ø 30	e ≥ 30	e ≥ 180	e ≥ 45

### Dimensions (mm)

Sensor	Pre-cabled (mm)		Connector (mm)	
	a	b	a	b
XS512B1M	53	42	62	42
XS518B1M	62	52	73	52
XS530B1M	62	52	73	52

(1) LED

# OsiSense® Inductive proximity sensors

General purpose

Cylindrical, increased range, flush mountable

Three-wire DC, solid-state output



XS106B3●●L2



XS108B3●●M8

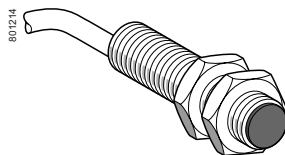

XS112B3●●L2

## Sensors, 3-wire 12–24 V $\overline{\text{DC}}$ , short case model

Sensing distance Sn, mm (in.)	Function	Output	Connection	Sold in lots of	Catalog Number	Weight kg	Weight (lb)	
<b>Ø 6.5, plain</b>								
2.5 (0.10)	NO	PNP	Pre-cabled (1)	1	XS106B3PAL2	0.060	(0.13)	
			M8 connector	1	XS106B3PAM8	0.030	(0.07)	
			M12 connector	1	XS106B3PAM12	0.050	(0.11)	
		NPN	Pre-cabled	1	XS106B3PAL2TQ	0.980	(2.16)	
			M8 connector	20	XS106B3PAM8TQ	0.320	(0.71)	
			M12 connector	20	XS106B3PAM12TQ	0.320	(0.71)	
	NC	PNP	Pre-cabled (1)	1	XS106B3NAL2	0.060	(0.13)	
			M8 connector	1	XS106B3NAM8	0.030	(0.07)	
			M12 connector	1	XS106B3NAM12	0.030	(0.07)	
		NPN	Pre-cabled	1	XS106B3NBL2	0.060	(0.13)	
			M8 connector	1	XS106B3NBM8	0.030	(0.07)	
			M12 connector	1	XS106B3NBM12	0.030	(0.07)	
<b>Ø 8, threaded M8 x 1</b>								
2.5 (0.10)	NO	PNP	Pre-cabled (1)	1	XS108B3PAL2	0.070	(0.15)	
			M8 connector	1	XS108B3PAM8	0.030	(0.07)	
			M12 connector	1	XS108B3PAM12	0.060	(0.13)	
			NPN	Pre-cabled	20	XS108B3PAL2TQ	1.120	(2.47)
				M8 connector	20	XS108B3PAM8TQ	0.460	(1.01)
				M12 connector	20	XS108B3PAM12TQ	0.940	(2.07)
		NC	PNP	Pre-cabled (1)	1	XS108B3NAL2	0.070	(0.15)
				M8 connector	1	XS108B3NAM8	0.030	(0.07)
				M12 connector	1	XS108B3NAM12	0.060	(0.13)
			NPN	Pre-cabled	20	XS108B3NAL2TQ	1.120	(2.47)
				M8 connector	20	XS108B3NAM8TQ	0.460	(1.01)
				M12 connector	20	XS108B3NAM12TQ	0.460	(1.01)
	4 (0.16)	NO	PNP	Pre-cabled (1)	1	XS112B3PAL2	0.090	(0.20)
				M12 connector	1	XS112B3PAM12	0.030	(0.07)
				Pre-cabled	20	XS112B3PAL2TQ	1.600	(3.53)
			NPN	Pre-cabled (1)	1	XS112B3PAL2TQ	0.470	(1.04)
				M12 connector	20	XS112B3PAM12TQ	0.470	(1.04)
				M12 connector	20	XS112B3PAM12TQ	0.470	(1.04)
		NC	PNP	Pre-cabled (1)	1	XS112B3NAL2	0.090	(0.20)
				M12 connector	1	XS112B3NAM12	0.030	(0.07)
				Pre-cabled	20	XS112B3NAL2TQ	1.600	(3.53)
			NPN	Pre-cabled (1)	1	XS112B3NAL2TQ	0.470	(1.04)
				M12 connector	20	XS112B3NAM12TQ	0.470	(1.04)
				M12 connector	20	XS112B3NAM12TQ	0.470	(1.04)

(1) For a 5 m cable replace L2 with L5.

Example: XS106B3PAL2 becomes XS106B3PAL5 with a 5 m cable.

# OsiSense® Inductive proximity sensors

General purpose

Cylindrical, increased range, flush mountable

Three-wire DC, solid-state output

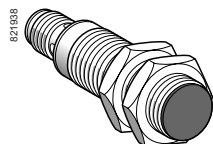

XS118B3●●M12

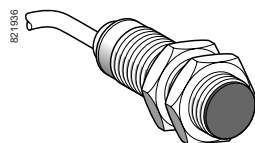

XS118B3●●L2

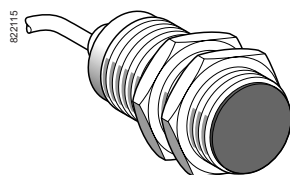

XS130B3●●L2

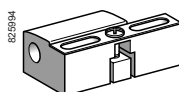

XSZB1●●

### Sensors, 3-wire 12–24 V DC, short case model (continued)

Sensing distance Sn, mm (in.)	Function	Output	Connection	Sold in lots of	Catalog Number	Weight kg	Weight (lb)	
<b>Ø 18, threaded M18 x 1</b>								
8 (0.31)	NO	PNP	Pre-cabled (1)	1	XS118B3PAL2	0.110	(0.24)	
			M12 connector	1	XS118B3PAM12	0.060	(0.13)	
			Pre-cabled	20	XS118B3PAL2TQ	2.000	(4.41)	
	NPN	PNP	M12 connector	20	XS118B3PAM12TQ	1.140	(2.51)	
			Pre-cabled (1)	1	XS118B3NAL2	0.110	(0.24)	
			M12 connector	1	XS118B3NAM12	0.060	(0.13)	
NC	PNP	PNP	Pre-cabled	20	XS118B3NAL2TQ	2.000	(4.41)	
			M12 connector	20	XS118B3NAM12TQ	1.140	(2.51)	
			Pre-cabled (1)	1	XS118B3PBL2	0.110	(0.24)	
NPN	PNP	PNP	M12 connector	1	XS118B3PBM12	0.060	(0.13)	
			Pre-cabled (1)	1	XS118B3NBL2	0.110	(0.24)	
			M12 connector	1	XS118B3NBM12	0.060	(0.13)	
<b>Ø 30, threaded M30 x 1.5</b>								
15 (0.59)	NO	PNP	Pre-cabled (1)	1	XS130B3PAL2	0.180	(0.40)	
			M12 connector	1	XS130B3PAM12	0.130	(0.29)	
			Pre-cabled	20	XS130B3PAL2TQ	3.360	(7.41)	
	NPN	PNP	PNP	M12 connector	20	XS130B3PAM12TQ	2.000	(4.41)
				Pre-cabled (1)	1	XS130B3NAL2	0.180	(0.40)
				M12 connector	1	XS130B3NAM12	0.130	(0.29)
NC	PNP	PNP	M12 connector	20	XS130B3NAM12TQ	2.000	(4.41)	
			Pre-cabled (1)	1	XS130B3PBL2	0.180	(0.40)	
			M12 connector	1	XS130B3PBM12	0.130	(0.29)	
NPN	PNP	PNP	Pre-cabled (1)	1	XS130B3NBL2	0.180	(0.40)	
			M12 connector	1	XS130B3NBM12	0.130	(0.29)	

### Accessories

Description	For use with sensors	Catalog Number	Weight kg	Weight (lb)
Mounting clamps	Ø 6.5 (plain)	XSZB165	0.005	(0.01)
	Ø 8 (M8 x 1)	XSZB108	0.006	(0.01)
	Ø 12 (M12 x 1)	XSZB112	0.006	(0.01)
	Ø 18 (M18 x 1)	XSZB118	0.010	(0.02)
	Ø 30 (M30 x 1.5)	XSZB130	0.020	(0.04)

(1) For a 5 m long cable replace L2 with L5.  
Example: XS118B3PAL2 becomes XS118B3PAL5 with a 5 m long cable.

# OsiSense® Inductive proximity sensors

General purpose

Cylindrical, increased range, flush mountable

Three-wire DC, solid-state output

## Sensors, 3-wire 12–48 V $\overline{DC}$ , long case model

Sensing dist. Sn, mm (in.)	Function	Output	Connection	Catalog Number	Weight kg (lb)
<b>Ø 8, threaded M8 x 1</b>					
2.5 (0.10)	NO	PNP	Pre-cabled (1)	<b>XS608B1PAL2</b>	0.035 (0.08)
			M12 connector	<b>XS608B1PAM12</b>	0.015 (0.03)
	NPN	PNP	Pre-cabled (1)	<b>XS608B1NAL2</b>	0.035 (0.08)
			M12 connector	<b>XS608B1NAM12</b>	0.015 (0.03)
	NC	PNP	Pre-cabled (1)	<b>XS608B1PBL2</b>	0.035 (0.08)
			M12 connector	<b>XS608B1PBM12</b>	0.015 (0.03)
NPN	PNP	Pre-cabled (1)	<b>XS608B1NBL2</b>	0.035 (0.08)	
		M12 connector	<b>XS608B1NBM12</b>	0.015 (0.03)	



XS608B1L2

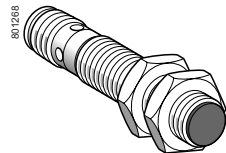

XS612B1L12

<b>Ø 12, threaded M12 x 1</b>					
4 (0.16)	NO	PNP	Pre-cabled (1)	<b>XS612B1PAL2</b>	0.075 (0.17)
			M12 connector	<b>XS612B1PAM12</b>	0.020 (0.04)
	NPN	PNP	Pre-cabled (1)	<b>XS612B1NAL2</b>	0.075 (0.17)
			M12 connector	<b>XS612B1NAM12</b>	0.020 (0.04)
	NC	PNP	Pre-cabled (1)	<b>XS612B1PBL2</b>	0.075 (0.17)
			M12 connector	<b>XS612B1PBM12</b>	0.020 (0.04)
NPN	PNP	Pre-cabled (1)	<b>XS612B1NBL2</b>	0.075 (0.17)	
		M12 connector	<b>XS612B1NBM12</b>	0.020 (0.04)	

<b>Ø 18, threaded M18 x 1</b>					
8 (0.31)	NO	PNP	Pre-cabled (1)	<b>XS618B1PAL2</b>	0.100 (0.22)
			M12 connector	<b>XS618B1PAM12</b>	0.040 (0.09)
			Remote screw term. connector	<b>XS618B1PAL01B (2)</b>	0.100 (0.22)
			Remote DIN 43650 connector	<b>XS618B1PAL01C</b>	0.100 (0.22)
			Remote M18 connector	<b>XS618B1PAL01G</b>	0.100 (0.22)
			M12 connector	<b>XS618B1NAM12</b>	0.040 (0.09)
	NPN	PNP	Pre-cabled (1)	<b>XS618B1NAL2</b>	0.100 (0.22)
			M12 connector	<b>XS618B1NAM12</b>	0.040 (0.09)
			Remote screw term. connector	<b>XS618B1NAL01B (2)</b>	0.100 (0.22)
			Remote DIN 43650 connector	<b>XS618B1NAL01C</b>	0.100 (0.22)
			Remote M18 connector	<b>XS618B1NAL01G</b>	0.100 (0.22)
			M12 connector	<b>XS618B1NBM12</b>	0.040 (0.09)
	NC	PNP	Pre-cabled (1)	<b>XS618B1PBL2</b>	0.100 (0.22)
			M12 connector	<b>XS618B1PBM12</b>	0.040 (0.09)
			Remote screw term. connector	<b>XS618B1PBL01B (2)</b>	0.100 (0.22)
			Remote DIN 43650 connector	<b>XS618B1PBL01C</b>	0.100 (0.22)
			Remote M18 connector	<b>XS618B1PBL01G</b>	0.100 (0.22)
			M12 connector	<b>XS618B1NBL2</b>	0.100 (0.22)
NPN	PNP	Pre-cabled (1)	<b>XS618B1NBL2</b>	0.100 (0.22)	
		M12 connector	<b>XS618B1NBM12</b>	0.040 (0.09)	
		Remote screw term. connector	<b>XS618B1NBL01B (2)</b>	0.100 (0.22)	
		Remote DIN 43650 connector	<b>XS618B1NBL01C</b>	0.100 (0.22)	
		Remote M18 connector	<b>XS618B1NBL01G</b>	0.100 (0.22)	
		M12 connector	<b>XS618B1NBM12</b>	0.040 (0.09)	



XS618B1L01B (2)



XS618B1L01C



XS618B1L01G

<b>Ø 30, threaded M30 x 1.5</b>					
15 (0.59)	NO	PNP	Pre-cabled (1)	<b>XS630B1PAL2</b>	0.205 (0.45)
			M12 connector	<b>XS630B1PAM12</b>	0.145 (0.32)
			Remote screw term. connector	<b>XS630B1PAL01B (2)</b>	0.205 (0.45)
			Remote DIN 43650 connector	<b>XS630B1PAL01C</b>	0.205 (0.45)
			Remote M18 connector	<b>XS630B1PAL01G</b>	0.205 (0.45)
			M12 connector	<b>XS630B1NAM12</b>	0.145 (0.32)
	NPN	PNP	Pre-cabled (1)	<b>XS630B1NAL2</b>	0.205 (0.45)
			M12 connector	<b>XS630B1NAM12</b>	0.145 (0.32)
			Remote screw term. connector	<b>XS630B1NAL01B (2)</b>	0.205 (0.45)
			Remote DIN 43650 connector	<b>XS630B1NAL01C</b>	0.205 (0.45)
			Remote M18 connector	<b>XS630B1NAL01G</b>	0.205 (0.45)
			M12 connector	<b>XS630B1NBM12</b>	0.145 (0.32)
	NC	PNP	Pre-cabled (1)	<b>XS630B1PBL2</b>	0.205 (0.45)
			M12 connector	<b>XS630B1PBM12</b>	0.145 (0.32)
			Remote screw term. connector	<b>XS630B1PBL01B (2)</b>	0.205 (0.45)
			Remote DIN 43650 connector	<b>XS630B1PBL01C</b>	0.205 (0.45)
			Remote M18 connector	<b>XS630B1PBL01G</b>	0.205 (0.45)
			M12 connector	<b>XS630B1NBL2</b>	0.205 (0.45)
NPN	PNP	Pre-cabled (1)	<b>XS630B1NBL2</b>	0.205 (0.45)	
		M12 connector	<b>XS630B1NBM12</b>	0.145 (0.32)	
		Remote screw term. connector	<b>XS630B1NBL01B (2)</b>	0.205 (0.45)	
		Remote DIN 43650 connector	<b>XS630B1NBL01C</b>	0.205 (0.45)	
		Remote M18 connector	<b>XS630B1NBL01G</b>	0.205 (0.45)	
		M12 connector	<b>XS630B1NBM12</b>	0.145 (0.32)	



XSZB108

Accessories					
Description	For use with sensors	Catalog Number	Weight kg (lb)		
Mounting clamps	Ø 8	<b>XSZB108</b>	0.006 (0.01)		
	Ø 12	<b>XSZB112</b>	0.006 (0.01)		
	Ø 18	<b>XSZB118</b>	0.010 (0.02)		
	Ø 30	<b>XSZB130</b>	0.020 (0.02)		

(1) For a 5 m cable replace L2 with L5; for a 10 m cable replace L2 with L10.

Example: XS608B1PAL2 becomes XS608B1PAL5 with a 5 m cable.

(2) Protective cable gland included with remote screw terminal connector.



# OsiSense® Inductive proximity sensors

General purpose

Cylindrical, increased range, flush mountable

Three-wire DC, solid-state output

Specifications				
Sensor type		XS1/XS6●●B●●M8	XS1/XS6●●B●●M12	XS1/XS6●●B●●L2
Product certifications		UL, CSA, CE		
Connection	Connector	M8	M12	–
	Pre-cabled	–	–	Length 2 m
	Remote connector	Remote screw terminal (L01B), DIN 43650 (L01C) or M18 connector (L01G) on 0.15 m flying lead		
Operating zone	∅ 6.5 and ∅ 8	mm	0–2 (0–0.08 in.)	
	∅ 12	mm	0–3.2 (0–0.13 in.)	
	∅ 18	mm	0–6.4 (0–0.25 in.)	
	∅ 30	mm	0–12 (0–0.47 in.)	
Differential travel		%	1–15 of effective sensing distance (Sr)	
Degree of protection	Conforming to IEC 60529		IP 65 and IP 67	IP 65 and IP 68, double insulation  except ∅ 6.5 and ∅ 8: IP 67
	Conforming to DIN 40050		IP 69K for ∅ 12, 18 and 30 sensors	
Storage temperature		°C	–40 to +85 (–40 to +185 °F)	
Operating temperature		°C	–25 to +70 (–13 to +158 °F)	
Materials	Case		Nickel plated brass (except XS608: stainless steel, grade 303)	
	Sensing face		PPS	
	Cable		–	PvR 3 x 0.34 mm <sup>2</sup> (22 AWG) except ∅ 6.5 and 8: 3 x 0.11 mm (27 AWG) <sup>2</sup>
Vibration resistance	Conforming to IEC 60068-2-6		25 gn, amplitude ± 2 mm (f = 10 to 55 Hz)	
Shock resistance	Conforming to IEC 60068-2-27		50 gn, duration 11 ms	
Output state indication			Yellow LED, 4 viewing ports at 90°	Yellow LED, circular
Rated supply voltage		V	XS1: ∴ 12–24 with protection against reverse polarity XS6: ∴ 12–48 with protection against reverse polarity	
Voltage limits (including ripple)		V	XS1: ∴ 10–36; XS6: ∴ 10–58	
Switching capacity		mA	≤ 200 with overload and short-circuit protection	
Voltage drop, closed state		V	≤ 2	
Current consumption, no-load		mA	≤ 10	
Maximum switching frequency	∅ 6.5, ∅ 8 and ∅ 12	Hz	2500	
	∅ 18	Hz	1000	
	∅ 30	Hz	500	
Delays	First-up	ms	≤ 10	
	Response	ms	≤ 0.2 for ∅ 6.5, ∅ 8 and ∅ 12, ≤ 0.3 for ∅ 18, ≤ 0.6 for ∅ 30	
	Recovery	ms	≤ 0.2 for ∅ 6.5, ∅ 8 and ∅ 12, ≤ 0.7 for ∅ 18, ≤ 1.4 for ∅ 30	

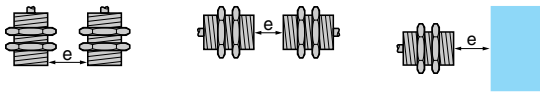
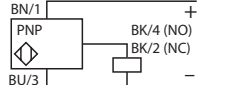
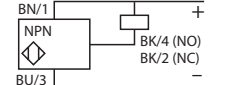
Wiring diagrams		Setup			
<b>Connector</b> M8:  M12:  BU: Blue BN: Brown BK: Black		<b>Minimum mounting distances (mm)</b> 			
<b>PNP</b> 	<b>NPN</b> 	<b>Sensors</b> ∅ 6.5 ∅ 8 ∅ 12 ∅ 18 ∅ 30	<b>Side by side</b> e ≥ 5 e ≥ 5 e ≥ 8 e ≥ 16 e ≥ 30	<b>Face to face</b> e ≥ 30 e ≥ 30 e ≥ 50 e ≥ 100 e ≥ 180	<b>Facing a metal object</b> e ≥ 8 e ≥ 8 e ≥ 12 e ≥ 24 e ≥ 45
For M8 connector, NO and NC outputs on terminal 4					

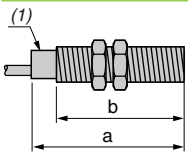
Dimensions (mm)								
 (1) LED	<b>Sensors</b>		<b>Pre-cabled (mm)</b>		<b>M8 connector (mm)</b>		<b>M12 connector (mm)</b>	
	<b>Short case model</b>		<b>a</b>	<b>b</b>	<b>a</b>	<b>b</b>	<b>a</b>	<b>b</b>
	∅ 6.5	XS106B3	33	–	42	–	45	–
	∅ 8	XS108B3	33	25	42	26	45	24
	∅ 12	XS112B3	35	25	–	–	50	30
	∅ 18	XS118B3	39	28	–	–	50	28
∅ 30	XS130B3	43	32	–	–	55	32	
<b>Sensors</b>		<b>Pre-cabled (mm)</b>		<b>M12 connector (mm)</b>				
<b>Long case model</b>		<b>a</b>	<b>b</b>	<b>a</b>	<b>b</b>	<b>a</b>	<b>b</b>	
∅ 8	XS6 08B1	51	42	62	40	–	–	
∅ 12	XS612B1	53	42	62	42	–	–	
∅ 18	XS618B1	62	52	74	52	–	–	
∅ 30	XS630B1	62	52	74	52	–	–	

# OsiSense® Inductive proximity sensors

General purpose

Cylindrical, increased range, flush mountable

Two-wire DC, solid-state output

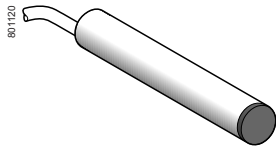

XS606B3●●L2

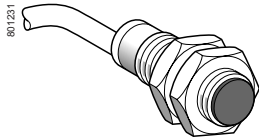

XS612B3●●L2

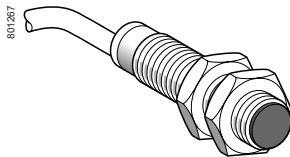

XS6●●B1●●L2

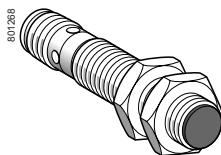

XS6●●B1●●M12

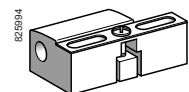

XSZB1●●

## Sensors, 2-wire 12–24 V $\overline{DC}$ , short case model

Sensing dist. Sn, mm (in.)	Function	Connection	Catalog Number	Weight kg (lb)
<b>Ø 6.5, plain</b>				
2.5 (0.10)	NO	Pre-cabled (1)	XS606B3CAL2	0.060 (0.13)
		Remote M12 connector	XS606B3CAL01M12	0.070 (0.15)
	NC	Pre-cabled (1)	XS606B3CBL2	0.060 (0.13)
<b>Ø 8, threaded M8 x 1</b>				
2.5 (0.10)	NO	Pre-cabled (1)	XS608B3CAL2	0.070 (0.15)
		Remote M12 connector	XS608B3CAL01M12	0.070 (0.15)
	NC	Pre-cabled (1)	XS608B3CBL2	0.070 (0.15)
		Remote M12 connector	XS608B3CBL01M12	0.070 (0.15)
<b>Ø 12, threaded M12 x 1</b>				
4 (0.16)	NO	Pre-cabled (1)	XS612B3DAL2	0.090 (0.20)
		M12 connector	XS612B3DAM12	0.030 (0.07)
	NC	Pre-cabled (1)	XS612B3DBL2	0.090 (0.20)
		M12 connector	XS612B3DBM12	0.030 (0.07)
<b>Ø 18, threaded M18 x 1</b>				
8 (0.31)	NO	Pre-cabled (1)	XS618B3DAL2	0.110 (0.24)
		M12 connector	XS618B3DAM12	0.060 (0.13)
	NC	Pre-cabled (1)	XS618B3DBL2	0.110 (0.24)
		M12 connector	XS618B3DBM12	0.060 (0.13)
<b>Ø 30, threaded M30 x 1.5</b>				
15 (0.59)	NO	Pre-cabled (1)	XS630B3DAL2	0.180 (0.40)
		M12 connector	XS630B3DAM12	0.130 (0.29)
	NC	Pre-cabled (1)	XS630B3DBL2	0.180 (0.40)
		M12 connector	XS630B3DBM12	0.180 (0.40)

## Sensors, 2-wire 12–48 V $\overline{DC}$ , long case model

Sensing dist. Sn, mm (in.)	Function	Connection	Catalog Number	Weight kg (lb)
<b>Ø 6.5, plain</b>				
2.5 (0.10)	NO	Pre-cabled (1)	XS606B1DAL2	0.060 (0.13)
		NC	Pre-cabled (1)	XS606B1DBL2
<b>Ø 8, threaded M8 x 1</b>				
2.5 (0.10)	NO	Pre-cabled (1)	XS608B1DAL2	0.035 (0.08)
		M12 connector	XS608B1DAM12	0.015 (0.03)
	NC	Pre-cabled (1)	XS608B1DBL2	0.035 (0.08)
		M12 connector	XS608B1DBM12	0.015 (0.03)
<b>Ø 12, threaded M12 x 1</b>				
4 (0.16)	NO	Pre-cabled (1)	XS612B1DAL2	0.180 (0.40)
		M12 connector	XS612B1DAM12	0.020 (0.44)
	NC	Pre-cabled (1)	XS612B1DBL2	0.075 (0.17)
		M12 connector	XS612B1DBM12	0.020 (0.44)
<b>Ø 18, threaded M18 x 1</b>				
8 (0.31)	NO	Pre-cabled (1)	XS618B1DAL2	0.100 (0.22)
		M12 connector	XS618B1DAM12	0.040 (0.09)
	NC	Pre-cabled (1)	XS618B1DBL2	0.100 (0.22)
		M12 connector	XS618B1DBM12	0.040 (0.09)
<b>Ø 30, threaded M30 x 1.5</b>				
15 (0.59)	NO	Pre-cabled (1)	XS630B1DAL2	0.205 (0.45)
		M12 connector	XS630B1DAM12	0.145 (0.32)
	NC	Pre-cabled (1)	XS630B1DBL2	0.205 (0.45)
		M12 connector	XS630B1DBM12	0.145 (0.32)

### Accessories

Description	For use with sensors	Catalog Number	Weight kg (lb)
Mounting clamps	Ø 6.5 (plain)	XSZB165	0.005 (0.01)
	Ø 8 (M8 x 1)	XSZB108	0.006 (0.01)
	Ø 12 (M12 x 1)	XSZB112	0.006 (0.01)
	Ø 18 (M18 x 1)	XSZB118	0.010 (0.02)
	Ø 30 (M30 x 1.5)	XSZB130	0.020 (0.04)

(1) For a 5 m cable replace L2 with L5.

Example: XS606B3CAL2 becomes XS606B3CAL5 with a 5 m cable.



# OsiSense® Inductive proximity sensors

General purpose

Cylindrical, increased range, flush mountable

Two-wire DC, solid-state output

Specifications			
Sensor type		XS6●●B3D●M12, XS6●●B1D●M12	XS6●●B3D●L2, XS6●●B1D●L2
Product certifications		UL, CSA, CE	
Connection	Connector	M12 or remote M12 connector (L01M12) on 0.15 m flying lead	
	Pre-cabled	Length 2 m	
Operating zone	∅ 6.5 and ∅ 8	mm	0–2 (0–0.08 in.)
	∅ 12	mm	0–3.2 (0–0.13 in.)
	∅ 18	mm	0–6.4 (0–0.25 in.)
	∅ 30	mm	0–12 (0–0.47 in.)
Differential travel	%	1–15 of effective sensing distance (Sr)	
Degree of protection	Conforming to IEC 60529	IP 65 and IP 67	IP 65 and IP 68 double isolation ☐ (except ∅ 6.5 and ∅ 8: IP 67)
	Conforming to DIN 40050	IP 69K	
Storage temperature	°C	-40 to +85 (-40 to +185 °F)	
Operating temperature	°C	-25 to +70 (-13 to +158 °F)	
Materials	Case	Nickel plated brass (except XS606B1D or XS608B1D: stainless steel, grade 303)	
	Sensing face	PPS	
	Cable	PvR 2 x 0.34 mm <sup>2</sup> (22 AWG) except ∅ 6.5 and ∅ 8: 2 x 0.11 mm <sup>2</sup> (27 AWG)	
Vibration resistance	Conforming to IEC 60068-2-6	25 gn, amplitude ± 2 mm (f = 10 to 55 Hz)	
Shock resistance	Conforming to IEC 60068-2-27	50 gn, duration 11 ms	
Output state indication		Yellow LED, 4 viewing ports at 90°	
Rated supply voltage	V	--- 12–48 non-polarized for XS6●●B1D, --- 12–24 non-polarized for XS6●●B3D (except ∅ 6.5 and ∅ 8 short case models, which are polarized), with protection against reverse polarity	
Voltage limits (including ripple)	V	--- 10–58 for XS6●●B1D --- 10–36 for XS6●●B3D	
Switching capacity	mA	≤ 100 with overload and short-circuit protection	
Voltage drop, closed state	V	4	
Current consumption, no-load	mA	≤ 0.5 mA	
Maximum switching frequency	∅ 6.5, ∅ 8	Hz	3000
	∅ 12	Hz	2000
	∅ 18	Hz	1000
	∅ 30	Hz	500
Delays	First-up	ms	≤ 10
	Response	ms	≤ 0.3
	Recovery	ms	≤ 0.3

## Wiring diagrams Setting-up

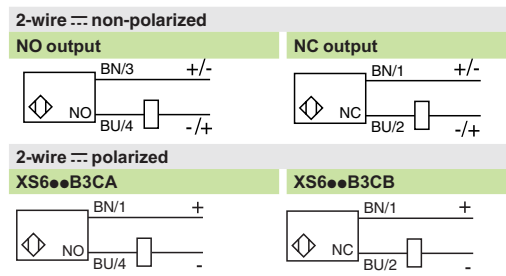
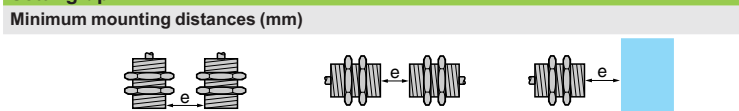

Sensors	Side by side	Face to face	Facing a metal object
∅ 6.5	e ≥ 5	e ≥ 30	e ≥ 8
∅ 8	e ≥ 5	e ≥ 30	e ≥ 8
∅ 12	e ≥ 8	e ≥ 50	e ≥ 12
∅ 18	e ≥ 16	e ≥ 100	e ≥ 25
∅ 30	e ≥ 30	e ≥ 180	e ≥ 45

## Dimensions (mm)

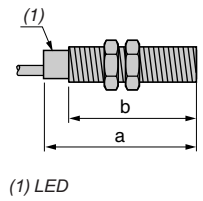

Sensors	Pre-cabled (mm)		M12 connector (mm)	
	a	b	a	b
<b>Short case model</b>				
∅ 6.5	XS606B3D	33	–	–
∅ 8	XS608B3D	33	25	24
∅ 12	XS612B3D	35	25	50
∅ 18	XS618B3D	39	28	50
∅ 30	XS630B3D	43	32	55
<b>Long case model</b>				
∅ 6.5	XS606B1D	51	–	–
∅ 8	XS608B1D	51	42	62
∅ 12	XS612B1D	53	42	62
∅ 18	XS618B1D	62	52	74
∅ 30	XS630B1D	62	52	74

# OsiSense® Inductive proximity sensors

General purpose

Cylindrical, increased range, flush mountable

Two-wire AC or DC <sup>(1)</sup>

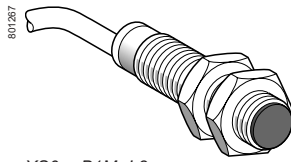

XS6●●B1M●L2

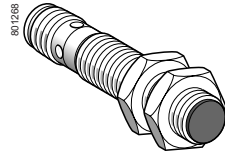

XS6●●B1●●U20

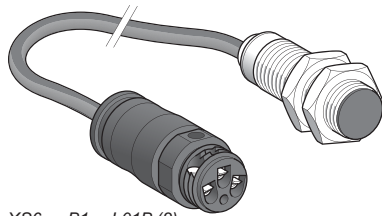

XS6●●B1●●L01B (2)

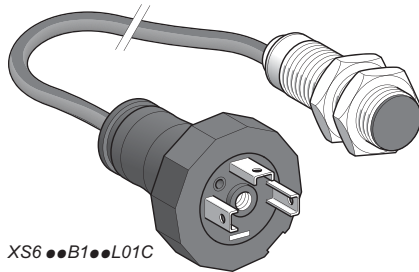

XS6●●B1●●L01C

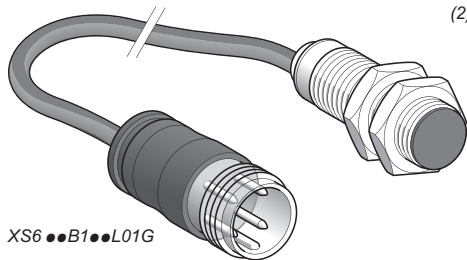

XS6●●B1●●L01G

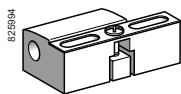

XSZB1●●

## Sensors, 2-wire 24–240 V $\bar{\sim}$ , long case model

Sensing distance Sn, mm (in.)	Function	Connection	Catalog Number	Weight kg (lb)
<b>Ø 12, threaded M12 x 1</b>				
4 (0.16)	NO	Pre-cabled <sup>(1)</sup>	<b>XS612B1MAL2</b>	0.075 (0.17)
		1/2"-20UNF connector	<b>XS612B1MAU20</b>	0.025 (0.06)
	NC	Pre-cabled <sup>(1)</sup>	<b>XS612B1MBL2</b>	0.075 (0.17)
		1/2"-20UNF connector	<b>XS612B1MBU20</b>	0.025 (0.06)

## Ø 18, threaded M18 x 1

8 (0.31)	NO	Pre-cabled <sup>(1)</sup>	<b>XS618B1MAL2</b>	0.100 (0.22)
		1/2"-20UNF connector	<b>XS618B1MAU20</b>	0.060 (0.13)
		Remote screw terminal connector	<b>XS618B1MAL01B (2)</b>	0.100 (0.22)
		Remote DIN 43650A connector	<b>XS618B1MAL01C</b>	0.100 (0.22)
	NC	Pre-cabled <sup>(1)</sup>	<b>XS618B1MBL2</b>	0.100 (0.22)
		1/2"-20UNF connector	<b>XS618B1MBU20</b>	0.060 (0.13)
		Remote screw terminal connector	<b>XS618B1MBL01B (2)</b>	0.100 (0.22)
		Remote DIN 43650A connector	<b>XS618B1MBL01C</b>	0.100 (0.22)
		Remote M18 connector	<b>XS618B1MBL01G</b>	0.100 (0.22)

## Ø 30, threaded M30 x 1.5

15 (0.59)	NO	Pre-cabled <sup>(2)</sup>	<b>XS630B1MAL2</b>	0.205 (0.45)
		1/2"-20UNF connector	<b>XS630B1MAU20</b>	0.145 (0.32)
		Remote screw terminal connector	<b>XS630B1MAL01B (2)</b>	0.205 (0.45)
		Remote DIN 43650A connector	<b>XS630B1MAL01C</b>	0.205 (0.45)
	NC	Pre-cabled <sup>(2)</sup>	<b>XS630B1MBL2</b>	0.205 (0.45)
		1/2"-20UNF connector	<b>XS630B1MBU20</b>	0.145 (0.32)
		Remote screw terminal connector	<b>XS6 30B1MBL01B (2)</b>	0.205 (0.45)
		Remote DIN 43650A connector	<b>XS6 30B1MBL01C</b>	0.205 (0.45)
		Remote M18 connector	<b>XS6 30B1MBL01G</b>	0.205 (0.45)

## Accessories

Description	For use with sensors	Catalog Number	Weight kg (lb)
Mounting clamps	Ø 12	<b>XSZB112</b>	0.006 (0.01)
	Ø 18	<b>XSZB118</b>	0.010 (0.02)
	Ø 30	<b>XSZB130</b>	0.020 (0.04)

<sup>(1)</sup> For a 5 m cable replace L2 with L5; for a 10 m cable replace L2 with L10.  
Example: XS612B1MAL2 becomes **XS612B1MAL5** with a 5 m cable.  
<sup>(2)</sup> Protective cable gland included with remote screw terminal connector.

# OsiSense® Inductive proximity sensors

General purpose  
Cylindrical, increased range, flush mountable  
Two-wire AC or DC

Specifications		XS6●●B1M●U20	XS6●●B1M●L●
Sensor type			
Product certifications		UL, CSA, CE	
Connection	Connector	1/2" - 20 UNF	–
	Pre-cabled	–	Length 2 m
	Remote connector	Remote screw terminal (L01B), DIN 43650A (L01C) or M18 connector (L01G) on 0.15 m flying lead	
Operating zone	Ø 12	mm	0–3.2 (0–0.13 in.)
	Ø 18	mm	0–6.4 (0–0.25 in.)
	Ø 30	mm	0–12 (0–0.47 in.)
Differential travel		%	1–15 of effective sensing distance (Sr)
Degree of protection	Conforming to IEC 60529	IP 65 and IP 67	
	Conforming to DIN 40050	IP 69K	
Storage temperature		°C	-40 to +85 (-40 to +185 °F)
Operating temperature		°C	-25 to +70 (-13 to +158 °F)
Materials	Case	Nickel plated brass	
	Sensing face	PPS	
	Cable	PvR 2 x 0.34 mm <sup>2</sup> (22 AWG)	
Vibration resistance	To IEC 60068-2-6	25 gn, amplitude ± 2 mm (f = 10 to 55 Hz)	
Shock resistance	To IEC 60068-2-27	50 gn, duration 11 ms	
Output state indication		Yellow LED: circular on pre-cabled version Yellow LED with 4 viewing ports at 90° on connector version	
Rated supply voltage		V	≈ 24–240 (~ 50/60 Hz)
Voltage limits (including ripple)		V	≈ 20–264
Switching capacity	XS612B1M●●●	mA	5–200 (2)
	XS618B1M●●●, XS630B1M●●●	mA	~ 5–300 or ~ 5–200 (1)
Voltage drop, closed state		V	≤ 5.5
Current consumption, no-load		mA	≤ 0.8
Maximum switching frequency (a.c./d.c. supply)	Ø 12	Hz	~ 1000 / ~ 25
	Ø 18	Hz	~ 1000 / ~ 25
	Ø 30	Hz	~ 500 / ~ 25
Delays	First-up	ms	≤ 25 for Ø 18 and Ø 30 sensors; ≤ 20 for Ø 12 sensors
	Response	ms	≤ 0.5
	Recovery	ms	≤ 0.2 for Ø 12 sensors; ≤ 0.5 for Ø 18 sensors; ≤ 2 for Ø 30 sensors

(1) A 0.4 A "fast-acting" fuse must be connected in series with the load.

## Wiring diagrams



## Setup

### Minimum mounting distances (mm)



Sensors	Side by side	Face to face	Facing a metal object
Ø 12	e ≥ 8	e ≥ 50	e ≥ 12
Ø 18	e ≥ 16	e ≥ 100	e ≥ 25
Ø 30	e ≥ 30	e ≥ 180	e ≥ 45

## Dimensions (mm)



(1) LED

Sensors	Pre-cabled (mm)		Connector (mm)	
	a	b	a	b
Ø 12 XS612B1M●	53	42	62	42
Ø 18 XS618B1M●	62	52	73	52
Ø 30 XS630B1M●	62	52	73	52

# OsiSense® Inductive proximity sensors

General purpose

Cylindrical, increased range, non-flush mountable

Three-wire DC, solid-state output



XS612B4●●L2

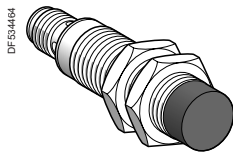

XS618B4●●M12



XS630B4●●M12



XSZB●●●

## Sensors, 3-wire 12–48 V, long case model

### Ø 12, threaded M12 x 1

Sensing distance Sn, mm (in.)	Function	Output	Connection	Catalog Number	kg	Weight (lb)
7 (0.28)	NO	PNP	Pre-cabled (1)	XS612B4PAL2	0.075	(0.17)
			M12 connector	XS612B4PAM12	0.020	(0.04)
	NPN	PNP	Pre-cabled (1)	XS612B4NAL2	0.075	(0.17)
			M12 connector	XS612B4NAM12	0.020	(0.04)
	NC	PNP	Pre-cabled (1)	XS612B4PBL2	0.075	(0.17)
			M12 connector	XS612B4PBM12	0.020	(0.04)
NPN	PNP	Pre-cabled (1)	XS612B4NBL2	0.075	(0.17)	
		M12 connector	XS612B4NBM12	0.020	(0.04)	

### Ø 18, threaded M18 x 1

Sensing distance Sn, mm (in.)	Function	Output	Connection	Catalog Number	kg	Weight (lb)
12 (0.47)	NO	PNP	Pre-cabled (1)	XS618B4PAL2	0.100	(0.22)
			M12 connector	XS618B4PAM12	0.040	(0.09)
	NPN	PNP	Pre-cabled (1)	XS618B4NAL2	0.100	(0.22)
			M12 connector	XS618B4NAM12	0.040	(0.09)
	NC	PNP	Pre-cabled (1)	XS618B4PBL2	0.100	(0.22)
			M12 connector	XS618B4PBM12	0.040	(0.09)
NPN	PNP	Pre-cabled (1)	XS618B4NBL2	0.100	(0.22)	
		M12 connector	XS618B4NBM12	0.040	(0.09)	

### Ø 30, threaded M30 x 1.5

Sensing distance Sn, mm (in.)	Function	Output	Connection	Catalog Number	kg	Weight (lb)
22 (0.87)	NO	PNP	Pre-cabled (1)	XS630B4PAL2	0.205	(0.45)
			M12 connector	XS630B4PAM12	0.145	(0.32)
	NPN	PNP	Pre-cabled (1)	XS630B4NAL2	0.205	(0.45)
			M12 connector	XS630B4NAM12	0.145	(0.32)
	NC	PNP	Pre-cabled (1)	XS630B4PBL2	0.205	(0.45)
			M12 connector	XS630B4PBM12	0.145	(0.32)
NPN	PNP	Pre-cabled (1)	XS630B4NBL2	0.205	(0.45)	
		M12 connector	XS630B4NBM12	0.145	(0.32)	

## Accessories

Description	For use with sensors	Catalog Number	kg	Weight (lb)
Mounting clamps	Ø 12	XSZB112	0.006	(0.01)
	Ø 18	XSZB118	0.010	(0.02)
	Ø 30	XSZB130	0.020	(0.04)

(1) For a 5 m cable replace L2 with L5; for a 10 m cable replace L2 with L10.  
Example: XS612B4PAL2 becomes XS612B4PAL5 with a 5 m cable.

# OsiSense® Inductive proximity sensors

General purpose

Cylindrical, increased range, non-flush mountable

Three-wire DC, solid-state output

Specifications		XS6●●B4●●M12	XS6●●B4●●L2
Sensor type			
Product certifications		UL, CSA, CE	
Connection	Connector	M12	—
	Pre-cabled	—	Length 2 m
Operating zone	∅ 12	mm	0–5.6 (0–0.22 in.)
	∅ 18	mm	0–9.6 (0–0.38 in.)
	∅ 30	mm	0–17.6 (0–0.69 in.)
Differential travel		%	1–15 of effective sensing distance (Sr)
Degree of protection	Conforming to IEC 60529	IP 65 and IP 67	IP 65 and IP 68, double insulation <input type="checkbox"/>
Storage temperature		°C	-40 to +85 (-40 to +185 °F)
Operating temperature		°C	-25 to +70 (-13 to +158 °F)
Materials	Case	Nickel plated brass	
	Sensing face	PPS	
	Cable	—	PvR 3 x 0.34 mm <sup>2</sup> (22 AWG)
Vibration resistance	Conforming to IEC 60068-2-6	25 gn, amplitude ± 2 mm (f = 10 to 55 Hz)	
Shock resistance	Conforming to IEC 60068-2-27	50 gn, duration 11 ms	
Output state indication		Yellow LED: 4 viewing ports at 90°	Yellow LED: circular
Rated supply voltage		V	— 12–48 with protection against reverse polarity
Voltage limits (including ripple)		V	— 10–58
Switching capacity		mA	≤ 200 with overload and short-circuit protection
Voltage drop, closed state		V	≤ 2
Current consumption, no-load		mA	≤ 10
Maximum switching frequency	XS612B4●●●●	Hz	2500
	XS618B4●●●●	Hz	1000
	XS630B4●●●●	Hz	500
Delays	First-up	ms	≤ 10
	Response	ms	≤ 0.2 for ∅ 12, ≤ 0.3 for ∅ 18, ≤ 0.6 for ∅ 30
	Recovery	ms	≤ 0.2 for ∅ 12, ≤ 0.7 for ∅ 18, ≤ 1.4 for ∅ 30

## Wiring diagrams

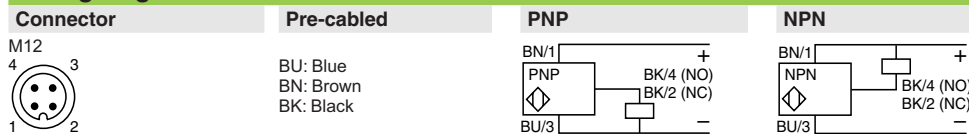

## Setup

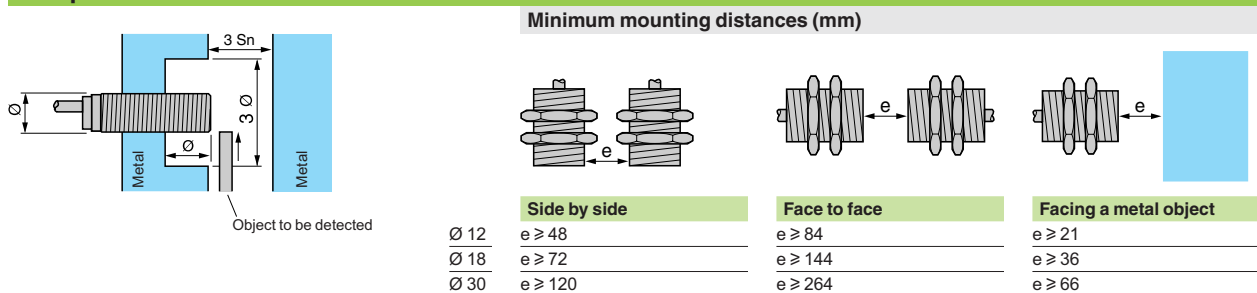

## Dimensions (mm)

	Pre-cabled (mm)		Connector (mm)		
	a	b	a	b	c
XS6					
∅ 12	55	42	66	42	5
∅ 18	60	44	72	44	8
∅ 30	63	41	74	41	13

(1) LED

# OsiSense® Inductive proximity sensors

General purpose

Cylindrical, increased range, non-flush mountable

Two-wire AC or DC



XS6●●B4M●L2

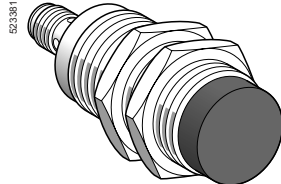

XS6●●B4M●U20

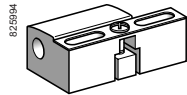

XSZB1●●

## Sensors, 2-wire ~ 24–240 V, long case model

### Ø 18, threaded M18 x 1

Sensing distance Sn, mm (in.)	Function	Connection	Catalog Number	kg	Weight (lb)
12 (0.47)	NO	Pre-cabled (1)	<b>XS618B4MAL2</b>	0.120	(0.26)
		1/2"-20UNF connector	<b>XS618B4MAU20</b>	0.060	(0.13)
	NC	Pre-cabled (1)	<b>XS618B4MBL2</b>	0.120	(0.26)
		1/2"-20UNF connector	<b>XS618B4MBU20</b>	0.060	(0.13)

### Ø 30, threaded M30 x 1.5

Sensing distance Sn, mm (in.)	Function	Connection	Catalog Number	kg	Weight (lb)
22 (0.87)	NO	Pre-cabled (1)	<b>XS630B4MAL2</b>	0.205	(0.45)
		1/2"-20UNF connector	<b>XS630B4MAU20</b>	0.145	(0.32)
	NC	Pre-cabled (1)	<b>XS630B4MBL2</b>	0.205	(0.45)
		1/2"-20UNF connector	<b>XS630B4MBU20</b>	0.145	(0.32)

## Accessories

Description	For use with sensors	Catalog Number	kg	Weight (lb)
Mounting clamps	Ø 18	<b>XSZB118</b>	0.010	(0.02)
	Ø 30	<b>XSZB130</b>	0.020	(0.04)

(1) For a 5 m cable replace L2 with L5; for a 10 m cable replace L2 with L10.  
Example: XS618B4MAL2 becomes **XS618B4MAL5** with a 5 m cable.

Specifications		XS6●●B4M●U20	XS6●●B4M●L2
Sensor type			
Product certifications		UL, CSA, CE	
Connection	Connector	1/2"-20UNF	—
	Pre-cabled	—	Length 2 m
Operating zone	Ø 18	mm 0–9.6 (0–0.38 in.)	
	Ø 30	mm 0–17.6 (0–0.69 in.)	
Differential travel		% 1–15 of effective sensing distance (Sr)	
Degree of protection	Conforming to IEC 60529	IP 65 and IP 67	IP 65 and IP 68, double insulation □
Storage temperature		°C -40 to +85 (-40 to +185 °F)	
Operating temperature		°C -25 to +70 (-13 to +158 °F)	
Materials	Case	Nickel plated brass	
	Sensing face	PPS	
	Cable	—	PvR 2 x 0.34 mm <sup>2</sup> (22 AWG)
Vibration resistance	Conforming to IEC 60068-2-6	25 gn, amplitude ± 2 mm (f = 10 to 55 Hz)	
Shock resistance	Conforming to IEC 60068-2-27	50 gn, duration 11 ms	
Output state indication		Yellow LED: 4 viewing ports at 90°	Yellow LED: circular
Rated supply voltage		V ~ or — 24–240 (~ 50/60 Hz)	
Voltage limits (including ripple)		V ~ or — 20–264	
Switching capacity		mA ~ 5–300 or — 5–200 (1)	
Voltage drop, closed state		V ≤ 5.5	
Residual current, open state		mA ≤ 0.8	
Maximum switching frequency	XS618B4M●●●	Hz ~ 25 or — 1000	
	XS630B4M●●●	Hz ~ 25 or — 300	
Delays	First-up	ms ≤ 30 XS618B4M●●● and XS630B4M●●●	
	Response	ms ≤ 0.5	
	Recovery	ms ≤ 0.5 XS618B4M●●●, ≤ 2 XS630B4M●●●	

(1) A 0.4 A "fast-acting" fuse must be connected in series with the load.

## Wiring diagrams

Connector	Pre-cabled	2-wire ~ or —
1/2"-20UNF	BU: Blue BN: Brown	NO or NC output
		±: on connector models only

## Setup

### Minimum mounting distances (mm)

Mounting Type	Ø 18	Ø 30
Side by side	e ≥ 72	e ≥ 120
Face to face	e ≥ 144	e ≥ 264
Facing a metal object	e ≥ 36	e ≥ 66

## Dimensions (mm)

(1) LED

XS6	Pre-cabled (mm)		Connector (mm)		
	a	b	a	b	c
Ø 18	60	44	72	44	8
Ø 30	63	41	74	41	13

Schneider Electric USA, Inc.

[www.SeSensors.com](http://www.SeSensors.com)

Schneider Electric Sensor  
Competency Center  
1875 Founders Drive  
Dayton OH 45420  
(800) 435-2121

The information and dimensions in this catalog are provided for the convenience of our customers. While this information is believed to be accurate, Schneider Electric reserves the right to make updates and changes without prior notification and assumes no liability for any errors or omissions.

Design: Schneider Electric  
Photos: Schneider Electric

© 2010 Schneider Electric. All Rights Reserved.

June 2010

9006CT1006