

IEC Appliance Inlet C14 with Fuseholder 1- or 2-pole



Screw-On Version



Snap-in version



Pick & Place Version



Description

- Panel Mount :
Sandwich/rear-side
- 2 Functions :
Appliance Inlet Protection class I , with or without Fuseholder for fuse-links 5 x 20 mm on the rear-side 1- or 2-pole
- For PCB mounting
- Pick and place version

Approvals

- Approval Reference Type: GSF1
- VDE Certificate Number: 40024857
- UL File Number: E93617, E96454
- CSA Certification Record: 38456
- CCC File Number: 2006010204183182

Characteristics

- PCB mount with snap-in or screw-on feet
Suitable for automatic PCB assembling
- All single elements are already wired
- Fuseholder on the inside of the equipment prevents accidental use of incorrect fuse-links by the user
- With or without rear-side insulation cover
- Blister tray as optional packaging variant
- Suitable for use in equipment according to IEC/UL 60950

Other versions on request

- Ground terminal with quick-connect terminal 6,3 x 0,8 mm
- Ground terminal with solder terminal
- For protection class II

Weblinks

[pdf datasheet](#), [html-datasheet](#), [General Product Information](#), [Approvals](#), [CE declaration of conformity](#), [RoHS](#), [CHINA-RoHS](#), [REACH](#), [Distributor-Stock-Check](#), [Accessories](#), [Detailed request for product](#), [Microsite](#)

Newly available variants corresponding to V-Lock mating cordset. The connector is equipped with a notch intended for use with the latching cordset. The cord latching system prevents against accidental removal of the cordset.

Technical Data

Ratings IEC	10A / 250VAC; 50Hz	appliance inlet/-outlet	C14 acc. to IEC 60320-1, UL 498, CSA C22.2 no. 42 (for cold conditions) pin-temperature 70 °C, 10A, Protection Class I
Ratings UL/CSA	10A / 250VAC; 60Hz without fuseholder 16A (UL)	Fuseholder	optional, 1 or 2 pole, Shocksafe category PC2 acc. to IEC 60127-6, for fuse-links 5 x 20mm
Dielectric Strength	> 3 kVAC between L-N > 4 kVAC between L/N-PE (1 min/50Hz)	Rated Power Acceptance @ Ta 23 °C	5 x 20: 3.15W (1 pole)/ 2.5W (2-pole) per pole
Allowable Operation Temperature	-25 °C to 70 °C	Power Acceptance @ Ta > 23°C	Admissible power acceptance at higher ambient temperature see derating curves
IP-Protection	from front side IP 40 acc. to IEC 60529		
Insulation cover	Suitable for appliances with protection class I acc. to IEC 61140		
Terminal	For PCB mounting		
Panel Thickness S	Snap-in: 1.5/2/2.5/3 mm		
Material: Housing	Thermoplastic, black, UL 94V-0		

Detailed information on product approvals, code requirements, usage instructions and detailed test conditions can be looked up in [General Product Information](#)

Dimensions [mm]

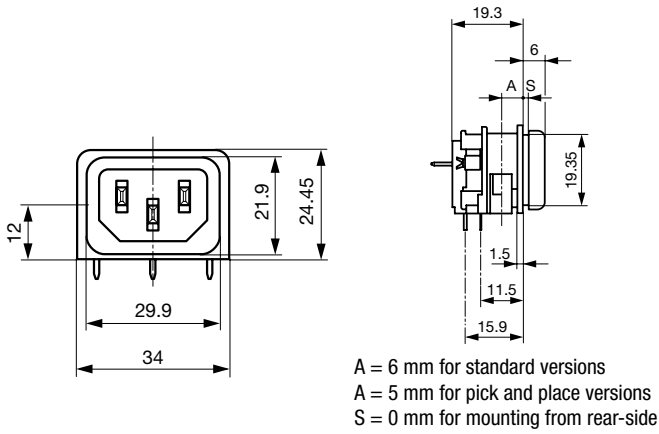

with insulation cover

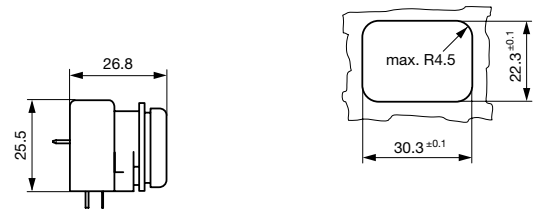

for mounting from rear-side

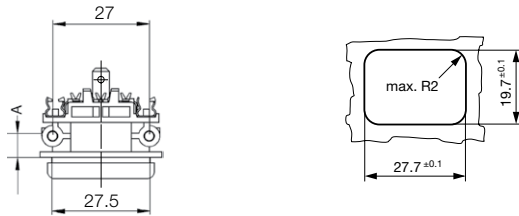

A = 6 mm for standard versions
A = 5 mm for pick and place versions

for sandwich mounting

Drilling diagrams

without fuseholder

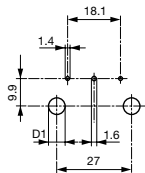

D1 for snap-in mounting = 6 ± 0.05
D1 for self-tapping screw = 3.6 ± 0.1

with 1-pole fuseholder

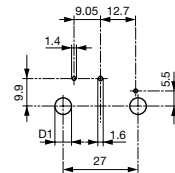

D1 for snap-in mounting = 6 ± 0.05
D1 for self-tapping screw = 3.6 ± 0.1

with 2-pole fuseholder

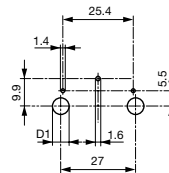

D1 for snap-in mounting = 6 ± 0.05
D1 for self-tapping screw = 3.6 ± 0.1

Pick and Place versions
without / with 1-pole or
2-pole fuseholder

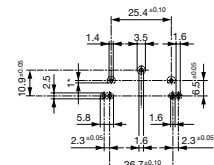

1* only for protection class II

Derating Curves

1-pole

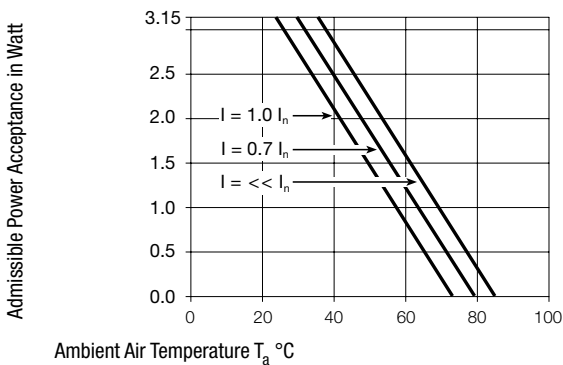

2-pole

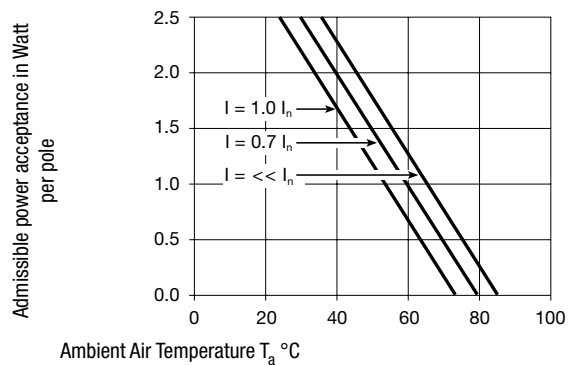

All Variants

Mounting side	Panel mounting	Panel Thickness s [mm]	Fuseholder	Ground terminal 4.8 x 0.8 mm	Ground terminal direction	Packaging	V-Lock	Order Number
Sandwich	Snap-in	1.5	-	●	angled to pin axis	-		GSF1.0202.31
Sandwich	Snap-in	1.5	-	●	straight	-		GSF1.0201.31
Sandwich	Snap-in	2	-	●	angled to pin axis	-		GSF1.0202.41
Sandwich	Snap-in	2	-	●	straight	-		GSF1.0201.41
Sandwich	Snap-in	2.5	-	●	angled to pin axis	-		GSF1.0202.51
Sandwich	Snap-in	2.5	-	●	straight	-		GSF1.0201.51
Sandwich	Snap-in	3	-	●	angled to pin axis	-		GSF1.0202.61
Sandwich	Snap-in	3	-	●	straight	-		GSF1.0201.61
Sandwich	Snap-in	1.5	1-pole	●	angled to pin axis	-		GSF1.1202.31
Sandwich	Snap-in	1.5	1-pole	●	straight	-		GSF1.1201.31
Sandwich	Snap-in	2	1-pole	●	angled to pin axis	-		GSF1.1202.41
Sandwich	Snap-in	2	1-pole	●	straight	-		GSF1.1201.41
Sandwich	Snap-in	2.5	1-pole	●	angled to pin axis	-		GSF1.1202.51
Sandwich	Snap-in	2.5	1-pole	●	straight	-		GSF1.1201.51
Sandwich	Snap-in	3	1-pole	●	angled to pin axis	-		GSF1.1202.61
Sandwich	Snap-in	3	1-pole	●	straight	-		GSF1.1201.61
Sandwich	Snap-in	1.5	2-pole	●	angled to pin axis	-		GSF1.2202.31
Sandwich	Snap-in	1.5	2-pole	●	straight	-		GSF1.2201.31
Sandwich	Snap-in	2	2-pole	●	angled to pin axis	-		GSF1.2202.41
Sandwich	Snap-in	2	2-pole	●	straight	-		GSF1.2201.41
Sandwich	Snap-in	2.5	2-pole	●	angled to pin axis	-		GSF1.2202.51
Sandwich	Snap-in	2.5	2-pole	●	straight	-		GSF1.2201.51
Sandwich	Snap-in	3	2-pole	●	straight	-		GSF1.2201.61
Sandwich	Screw	1.5	-	●	angled to pin axis	-		GSF1.0002.31
Sandwich	Screw	1.5	-	●	straight	-		GSF1.0001.31
Sandwich	Screw	2	-	●	angled to pin axis	-		GSF1.0002.41
Sandwich	Screw	2	-	●	straight	-		GSF1.0001.41
Sandwich	Screw	2.5	-	●	angled to pin axis	-		GSF1.0002.51
Sandwich	Screw	2.5	-	●	straight	-		GSF1.0001.51
Sandwich	Screw	3	-	●	angled to pin axis	-		GSF1.0002.61
Sandwich	Screw	3	-	●	straight	-		GSF1.0001.61
Sandwich	Screw	1.5	1-pole	●	angled to pin axis	-		GSF1.1002.31
Sandwich	Screw	1.5	1-pole	●	straight	-		GSF1.1001.31
Sandwich	Screw	2	1-pole	●	angled to pin axis	-		GSF1.1002.41
Sandwich	Screw	2	1-pole	●	straight	-		GSF1.1001.41
Sandwich	Screw	2.5	1-pole	●	angled to pin axis	-		GSF1.1002.51
Sandwich	Screw	2.5	1-pole	●	straight	-		GSF1.1001.51
Sandwich	Screw	2.5	1-pole	●	straight	-		GSF1.1006.51
Sandwich	Screw	3	1-pole	●	angled to pin axis	-		GSF1.1002.61
Sandwich	Screw	3	1-pole	●	straight	-		GSF1.1001.61
Sandwich	Screw	1.5	2-pole	●	angled to pin axis	-		GSF1.2002.31
Sandwich	Screw	1.5	2-pole	●	straight	-		GSF1.2001.31
Sandwich	Screw	2	2-pole	●	angled to pin axis	-		GSF1.2002.41
Sandwich	Screw	2	2-pole	●	straight	-		GSF1.2001.41
Sandwich	Screw	2.5	2-pole	●	angled to pin axis	-		GSF1.2002.51
Sandwich	Screw	2.5	2-pole	●	straight	-		GSF1.2001.51

Mounting side	Panel mounting	Panel Thickness s [mm]	Fuseholder	Ground terminal 4.8 x 0.8 mm	Ground terminal direction	Packaging	V-Lock	Order Number
Sandwich	Screw	3	2-pole	●	angled to pin axis	-		GSF1.2002.61
Sandwich	Screw	3	2-pole	●	straight	-		GSF1.2001.61
Rear Side	Snap-in	6	-	●	angled to pin axis	-		GSF1.0202.01
Rear Side	Snap-in	6	-	●	straight	-		GSF1.0201.01
Rear Side	Snap-in	6	1-pole	●	angled to pin axis	-		GSF1.1202.01
Rear Side	Snap-in	6	1-pole	●	straight	-		GSF1.1201.01
Rear Side	Snap-in	6	2-pole	●	angled to pin axis	-		GSF1.2202.01
Rear Side	Snap-in	6	2-pole	●	straight	-		GSF1.2201.01
Rear Side	Screw	6	-	●	angled to pin axis	-		GSF1.0002.01
Rear Side	Screw	6	-	●	straight	-		GSF1.0001.01
Rear Side	Screw	6	1-pole	●	angled to pin axis	-		GSF1.1002.01
Rear Side	Screw	6	1-pole	●	straight	-		GSF1.1001.01
Rear Side	Screw	6	2-pole	●	angled to pin axis	-		GSF1.2002.01
Rear Side	Screw	6	2-pole	●	straight	-		GSF1.2001.01
Rear Side	Metal snaps	6	-	●	angled to pin axis	Blister tray		GSF1.3402.01
Rear Side	Metal snaps	6	1-pole	●	angled to pin axis	Blister tray		GSF1.4402.01
Rear Side	Metal snaps	6	2-pole	●	angled to pin axis	Blister tray		GSF1.5402.01

Most Popular.

Availability for all products can be searched real-time: <http://www.schurter.com/en/Stock-Check/Stock-Check-SCHURTER>

Insulation cover must be ordered separately. Order No. 0098.0078

Optional blister tray packaging 250 Pcs

Packaging unit 50 Pcs

Accessories

Description



Assorted Covers
Rear Cover

0098.0078

Mating Outlets/Connectors

Category / Description



[Appliance Outlet Overview complete](#)

IEC Appliance Outlet F, Screw-on Mounting, Front Side, Solder Terminal	4787
IEC Appliance Outlet F, Snap-in Mounting, Front Side, Solder or Quick-connect Terminal	4788
IEC Appliance Outlet F or H, Screw-on Mounting, Front Side, Solder, PCB or Quick-connect Terminal	5091

[Appliance Outlet further types to GSF1](#)

Connector Overview complete



4782 Mounting: Power Cord, 3 x 1 mm ² / 3 x 18 AWG, Cable, Connector: IEC C13	4782
4022 Mounting: Power Supply Cord, 3 x 1.5 mm ² , Screw clamps, Connector: IEC C13	4022
4785 Mounting: Power Cord, 3 x 1 mm ² / 3 x 18 AWG, Cable, Connector: IEC C13	4785
4300-06 Mounting: Power Cord, 3 x 1 mm ² / 3 x 18 AWG, Cable, Connector: IEC C13	4300-06
4012 Mounting: Power Supply Cord, 3 x 1.5 mm ² , Screw clamps, Connector: IEC C13	4012
Connector further types to GSF1	...

Mating Outlets/Connectors shuttered

Power Cord Overview complete



Power cord with IEC connector C17, V-Lock, straight	VAC17KS
VAC13KS, Overview, diverse Connector IEC C13, cord end:	VAC13KS
Power Cord further types to GSF1	