

## BATTERY PROTECTION IC FOR 1-CELL PACK

[www.sii-ic.com](http://www.sii-ic.com)

© SII Semiconductor Corporation, 2001-2016

Rev.5.4\_02

The S-8261 Series is a lithium-ion / lithium polymer rechargeable battery protection IC incorporating high-accuracy voltage detection circuit and delay circuits.

The S-8261 Series is suitable for protection of single-cell lithium-ion / lithium polymer battery packs from overcharge, overdischarge and overcurrent.

### ■ Features

- (1) Internal high accuracy voltage detection circuit
  - Overcharge detection voltage 3.900 V to 4.500 V (applicable in 5 mV step) Accuracy:  $\pm 25$  mV (+25°C) and  $\pm 30$  mV (–5°C to +55°C)
  - Overcharge hysteresis voltage 0.1 V to 0.4 V\*<sup>1</sup> Accuracy:  $\pm 25$  mV  
The overcharge hysteresis voltage can be selected from the range 0.1 V to 0.4 V in 50 mV step.
  - Overdischarge detection voltage 2.000 V to 3.000 V (applicable in 10 mV step) Accuracy:  $\pm 50$  mV
  - Overdischarge hysteresis voltage 0.0 V to 0.7 V\*<sup>2</sup> Accuracy:  $\pm 50$  mV  
The overdischarge hysteresis voltage can be selected from the range 0.0 V to 0.7 V in 100 mV step.
  - Overcurrent 1 detection voltage 0.050 V to 0.300 V (applicable in 10 mV step) Accuracy:  $\pm 15$  mV
  - Overcurrent 2 detection voltage 0.500 V (fixed) Accuracy:  $\pm 100$  mV
- (2) High-withstand voltage (VM pin and CO pin: Absolute maximum rating = 28 V)
- (3) Delay times (overcharge:  $t_{CU}$ , overdischarge:  $t_{DL}$ , overcurrent 1:  $t_{IOV1}$ , overcurrent 2:  $t_{IOV2}$ ) are generated by an internal circuit. No external capacitor is necessary. Accuracy:  $\pm 20\%$
- (4) Three-step overcurrent detection circuit is included (overcurrent 1, overcurrent 2 and load short-circuiting).
- (5) 0 V battery charge function "Available" / "Unavailable" is selectable.
- (6) Power-down function "Yes" / "No" is selectable.
- (7) Charger detection function and abnormal charge current detection function
  - The overdischarge hysteresis is released by detecting negative voltage at the VM pin (–0.7 V typ.) (Charger detection function).
  - When the output voltage of the DO pin is high and the voltage at the VM pin is equal to or lower than the charger detection voltage (–0.7 V typ.), the output voltage of the CO pin goes low (Abnormal charge current detection function).
- (8) Low current consumption
  - Operation mode 3.5  $\mu$ A typ., 7.0  $\mu$ A max.
  - Power-down mode 0.1  $\mu$ A max.
- (9) Wide operating temperature range –40°C to +85°C
- (10) Lead-free, Sn 100%, halogen-free\*<sup>3</sup>

\*1. Overcharge release voltage = Overcharge detection voltage – Overcharge hysteresis voltage (where overcharge release voltage < 3.8 V is prohibited.)

\*2. Overdischarge release voltage = Overdischarge detection voltage + Overdischarge hysteresis voltage (where overdischarge release voltage > 3.4 V is prohibited.)

\*3. Refer to "■ Product Name Structure" for details.

### ■ Applications

- Lithium-ion rechargeable battery packs
- Lithium polymer rechargeable battery packs

### ■ Package

- SOT-23-6

■ **Block Diagram**

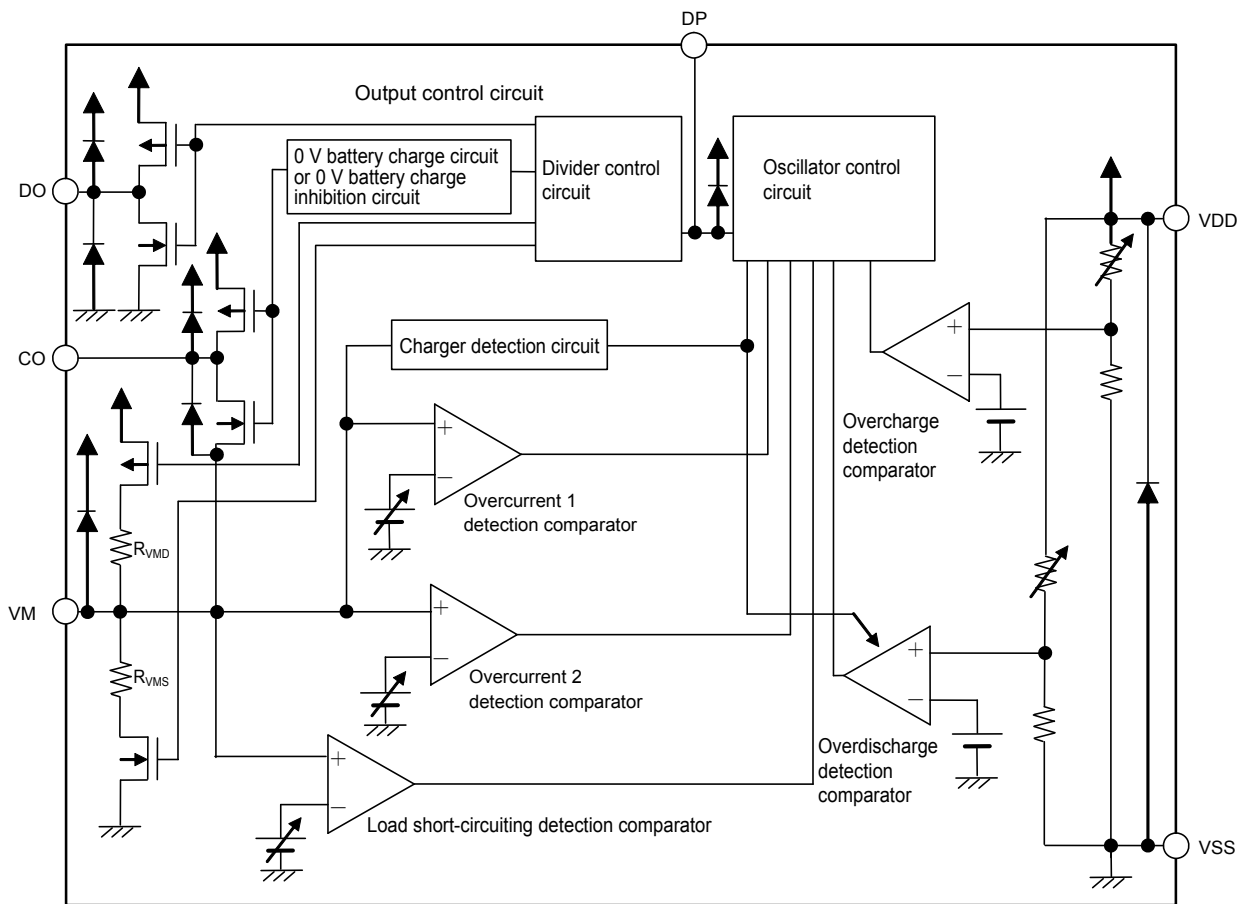

**Remark** All the diodes shown in the figure are parasitic diodes.

**Figure 1**

■ Product Name Structure

1. Product Name

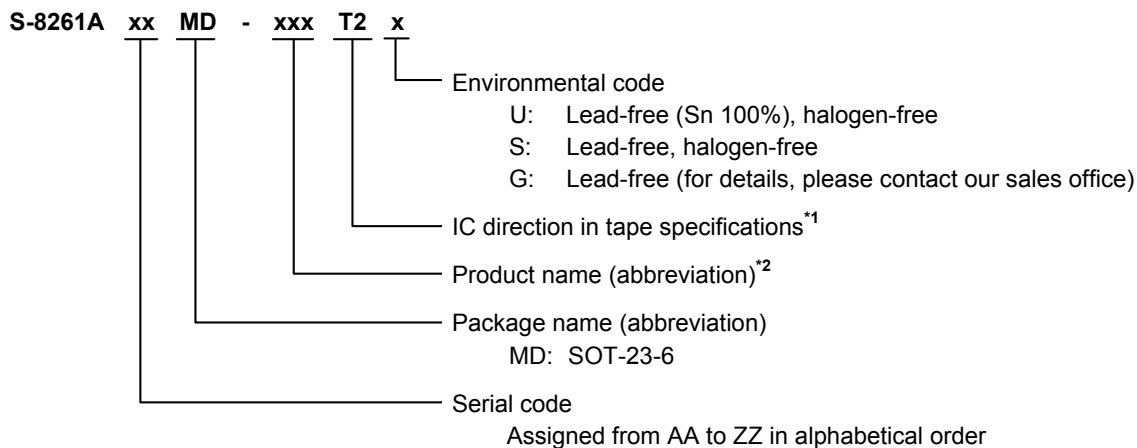

\*1. Refer to the tape drawing.

\*2. Refer to "3. Product Name List".

2. Package

Package name	Drawing code		
	Package	Tape	Reel
SOT-23-6	MP006-A-P-SD	MP006-A-C-SD	MP006-A-R-SD

**3. Product Name List**

**Table 1 (1 / 2)**

Product name	Overcharge detection voltage [V <sub>CU</sub> ]	Overcharge hysteresis voltage [V <sub>HC</sub> ]	Overdischarge detection voltage [V <sub>DL</sub> ]	Overdischarge hysteresis voltage [V <sub>HD</sub> ]	Overcurrent 1 detection voltage [V <sub>IOV1</sub> ]	0 V battery charge function	Delay time combination *1	Power-down function
S-8261AAGMD-G2GT2x	4.280 V	0.20 V	2.300 V	0 V	0.160 V	Available	(1)	Yes
S-8261AAHMD-G2HT2x	4.280 V	0.20 V	2.300 V	0 V	0.080 V	Available	(1)	Yes
S-8261AAJMD-G2JT2x	4.325 V	0.25 V	2.500 V	0.4 V	0.150 V	Unavailable	(1)	Yes
S-8261AALMD-G2LT2x	4.300 V	0.10 V	2.300 V	0 V	0.080 V	Unavailable	(1)	Yes
S-8261AAMMD-G2MT2x	4.300 V	0.10 V	2.300 V	0 V	0.200 V	Unavailable	(1)	Yes
S-8261AANMD-G2NT2x	4.275 V	0.10 V	2.300 V	0.1 V	0.100 V	Available	(1)	Yes
S-8261AAOMD-G2OT2x	4.280 V	0.20 V	2.300 V	0 V	0.130 V	Unavailable	(1)	Yes
S-8261AAPMD-G2PT2x	4.325 V	0.25 V	2.500 V	0.4 V	0.100 V	Unavailable	(1)	Yes
S-8261AARMD-G2RT2x	4.280 V	0.20 V	2.300 V	0 V	0.100 V	Available	(1)	Yes
S-8261AASMD-G2ST2x	4.280 V	0.20 V	2.300 V	0 V	0.150 V	Unavailable	(2)	Yes
S-8261AATMD-G2TT2x	4.300 V	0.10 V	2.300 V	0 V	0.080 V	Available	(3)	Yes
S-8261AAUMD-G2UT2x	4.275 V	0.10 V	2.300 V	0.1 V	0.100 V	Available	(4)	Yes
S-8261AAXMD-G2XT2x	4.350 V	0.10 V	2.300 V	0.1 V	0.100 V	Available	(4)	Yes
S-8261AAZMD-G2ZT2x	4.280 V	0.25 V	2.500 V	0.4 V	0.100 V	Unavailable	(1)	Yes
S-8261ABAMD-G3AT2x	4.350 V	0.20 V	2.500 V	0 V	0.200 V	Available	(4)	Yes
S-8261ABBMD-G3BT2x	4.275 V	0.20 V	2.300 V	0 V	0.130 V	Available	(1)	Yes
S-8261ABCMD-G3CT2x	4.300 V	0.20 V	2.300 V	0 V	0.130 V	Available	(1)	Yes
S-8261ABIMD-G3IT2x	4.275 V	0.20 V	2.300 V	0 V	0.200 V	Unavailable	(5)	Yes
S-8261ABJMD-G3JT2x	4.280 V	0.20 V	3.000 V	0 V	0.080 V	Available	(1)	Yes
S-8261ABKMD-G3KT2x	4.100 V	0.25 V	2.500 V	0.4 V	0.150 V	Unavailable	(1)	Yes
S-8261ABLMD-G3LT2x	4.275 V	0.20 V	2.300 V	0 V	0.050 V	Unavailable	(5)	Yes
S-8261ABMMD-G3MT2x	4.280 V	0.20 V	2.800 V	0 V	0.100 V	Available	(1)	Yes
S-8261ABNMD-G3NT2x	4.300 V	0.20 V	2.300 V	0 V	0.060 V	Available	(1)	Yes
S-8261ABPMD-G3PT2x	4.200 V	0.10 V	2.800 V	0.1 V	0.150 V	Unavailable	(1)	Yes
S-8261ABRMD-G3RT2x	4.275 V	0.20 V	2.500 V	0.4 V	0.150 V	Unavailable	(1)	Yes
S-8261ABSMD-G3ST2x	4.280 V	0.10 V	2.500 V	0.5 V	0.180 V	Unavailable	(1)	Yes
S-8261ABTMD-G3TT2x	4.280 V	0.20 V	3.000 V	0.4 V	0.080 V	Available	(5)	Yes
S-8261ABYMD-G3YT2x	4.275 V	0.10 V	2.300 V	0.1 V	0.100 V	Available	(6)	Yes
S-8261ABZMD-G3ZT2x	4.325 V	0.25 V	2.500 V	0.4 V	0.150 V	Unavailable	(6)	Yes
S-8261ACAMD-G4AT2x	4.280 V	0.20 V	2.300 V	0 V	0.130 V	Unavailable	(6)	Yes
S-8261ACBMD-G4BT2x	4.250 V	0.20 V	2.600 V	0.3 V	0.120 V	Unavailable	(1)	No
S-8261ACDMD-G4DT2x	4.350 V	0.25 V	2.300 V	0.7 V	0.250 V	Available	(7)	Yes
S-8261ACEMD-G4ET2x	3.900 V	0.10 V	2.000 V	0.3 V	0.100 V	Available	(1)	Yes
S-8261ACFMD-G4FT2x	4.280 V	0.20 V	2.300 V	0 V	0.100 V	Available	(8)	Yes
S-8261ACHMD-G4HT2x	4.465 V	0.30 V	2.100 V	0 V	0.150 V	Available	(9)	Yes
S-8261ACIMD-G4IT2x	4.250 V	0.20 V	2.400 V	0.5 V	0.100 V	Available	(1)	No
S-8261ACJMD-G4JT2x	4.275 V	0.10 V	2.300 V	0.1 V	0.150 V	Available	(1)	Yes
S-8261ACKMD-G4KT2x	4.280 V	0.20 V	2.800 V	0 V	0.130 V	Available	(1)	Yes

\*1. Refer to the **Table 2** about the details of the delay time combinations (1) to (9).

- Remark 1.** Please contact our sales office for the products with detection voltage value other than those specified above.  
**2.** x: G or U  
**3.** Please select products of environmental code = U for Sn 100%, halogen-free products.

Table 1 (2 / 2)

Product name	Overcharge detection voltage [V <sub>CU</sub> ]	Overcharge hysteresis voltage [V <sub>HC</sub> ]	Overdischarge detection voltage [V <sub>DL</sub> ]	Overdischarge hysteresis voltage [V <sub>HD</sub> ]	Overcurrent 1 detection voltage [V <sub>IOV1</sub> ]	0 V battery charge function	Delay time combination *1	Power-down function
S-8261ACMMD-G4MT2x	4.325 V	0.20 V	3.000 V	0.4 V	0.060 V	Unavailable	(1)	Yes
S-8261ACNMD-G4NT2x	4.215 V	0.10 V	2.300 V	0.1 V	0.130 V	Unavailable	(1)	Yes
S-8261ACSMD-G4ST2y	4.350 V	0.10 V	2.300 V	0.1 V	0.150 V	Available	(6)	Yes

\*1. Refer to the **Table 2** about the details of the delay time combinations (1) to (9).

**Remark 1.** Please contact our sales office for the products with detection voltage value other than those specified above.

2. x: G or U

3. y: S or U

4. Please select products of environmental code = U for Sn 100%, halogen-free products.

Table 2

Delay time combination	Overcharge detection delay time [t <sub>CU</sub> ]	Overdischarge detection delay time [t <sub>DL</sub> ]	Overcurrent 1 detection delay time [t <sub>IOV1</sub> ]	Overcurrent 2 detection delay time [t <sub>IOV2</sub> ]	Load short-circuiting detection delay time [t <sub>SHORT</sub> ]
(1)	1.2 s	144 ms	9 ms	2.24 ms	320 μs
(2)	1.2 s	144 ms	4.5 ms	2.24 ms	320 μs
(3)	4.6 s	36 ms	18 ms	9 ms	320 μs
(4)	4.6 s	144 ms	9 ms	2.24 ms	320 μs
(5)	1.2 s	36 ms	9 ms	2.24 ms	320 μs
(6)	1.2 s	144 ms	9 ms	1.12 ms	320 μs
(7)	1.2 s	290 ms	18 ms	2.24 ms	320 μs
(8)	1.2 s	144 ms	18 ms	2.24 ms	320 μs
(9)	0.3 s	36 ms	9 ms	1.12 ms	320 μs

**Remark** The delay times can be changed within the range listed **Table 3**. For details, please contact our sales office.

Table 3

Delay time	Symbol	Selection range			Remarks
Overcharge detection delay time	t <sub>CU</sub>	0.15 s	1.2 s <sup>*1</sup>	4.6 s	Choose from the left.
Overdischarge detection delay time	t <sub>DL</sub>	36 ms	144 ms <sup>*1</sup>	290 ms	Choose from the left.
Overcurrent 1 detection delay time	t <sub>IOV1</sub>	4.5 ms	9 ms <sup>*1</sup>	18 ms	Choose from the left.
Overcurrent 2 detection delay time	t <sub>IOV1</sub>	1.12 ms	2.24 ms <sup>*1</sup>	—	Choose from the left.
Load short-circuiting detection delay time	t <sub>SHORT</sub>	—	320 μs <sup>*1</sup>	600 μs	Choose from the left.

\*1. The value is the delay time of the standard products.

■ **Pin Configuration**

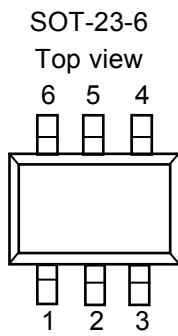

**Figure 2**

**Table 4**

Pin No.	Symbol	Description
1	DO	FET gate control pin for discharge (CMOS output)
2	VM	Voltage detection pin between VM and VSS (Overcurrent detection pin)
3	CO	FET gate control pin for charge (CMOS output)
4	DP	Test pin for delay time measurement
5	VDD	Positive power supply input pin
6	VSS	Negative power supply input pin

■ Absolute Maximum Ratings

Table 5

(Ta = 25°C unless otherwise specified)

Item	Symbol	Applied pin	Absolute Maximum Rating	Unit
Input voltage between VDD and VSS	V <sub>DS</sub>	VDD	V <sub>SS</sub> -0.3 to V <sub>SS</sub> +12	V
Input pin voltage for VM	V <sub>VM</sub>	VM	V <sub>DD</sub> -28 to V <sub>DD</sub> +0.3	V
Output pin voltage for CO	V <sub>CO</sub>	CO	V <sub>VM</sub> -0.3 to V <sub>DD</sub> +0.3	V
Output pin voltage for DO	V <sub>DO</sub>	DO	V <sub>SS</sub> -0.3 to V <sub>DD</sub> +0.3	V
Power dissipation	P <sub>D</sub>	—	250 (When not mounted on board)	mW
			650*1	mW
Operating ambient temperature	T <sub>opr</sub>	—	-40 to +85	°C
Storage temperature	T <sub>stg</sub>	—	-55 to +125	°C

\*1. When mounted on board  
[Mounted board]

- (1) Board size : 114.3 mm × 76.2 mm × t1.6 mm
- (2) Board name : JEDEC STANDARD51-7

**Caution** The absolute maximum ratings are rated values exceeding which the product could suffer physical damage. These values must therefore not be exceeded under any conditions.

(1) When mounted on board

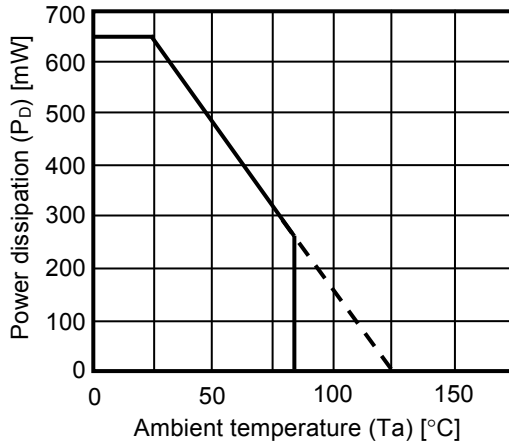

(2) When not mounted on board

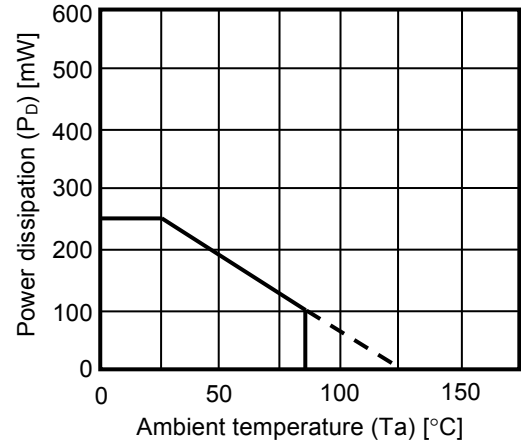

Figure 3 Power Dissipation of Package

■ **Electrical Characteristics**

**1. Except Detection Delay Time (25°C)**

**Table 6**

(Ta = 25°C unless otherwise specified)

Item	Symbol	Condition	Min.	Typ.	Max.	Unit	Test Condition	Test Circuit
<b>DETECTION VOLTAGE</b>								
Overcharge detection voltage V <sub>CU</sub> = 3.900 V to 4.500 V, 5 mV Step	V <sub>CU</sub>	—	V <sub>CU</sub> −0.025	V <sub>CU</sub>	V <sub>CU</sub> +0.025	V	1	1
		Ta = −5°C to 55°C*1	V <sub>CU</sub> −0.030	V <sub>CU</sub>	V <sub>CU</sub> +0.030	V	1	1
Overcharge hysteresis voltage V <sub>HC</sub> = 0.1 V to 0.4 V, 50 mV Step	V <sub>HC</sub>	—	V <sub>HC</sub> −0.025	V <sub>HC</sub>	V <sub>HC</sub> +0.025	V	1	1
Overdischarge detection voltage V <sub>DL</sub> = 2.000 V to 3.000 V, 10 mV Step	V <sub>DL</sub>	—	V <sub>DL</sub> −0.050	V <sub>DL</sub>	V <sub>DL</sub> +0.050	V	2	2
Overdischarge hysteresis voltage V <sub>HD</sub> = 0.0 V to 0.7 V, 100 mV Step	V <sub>HD</sub>	—	V <sub>HD</sub> −0.050	V <sub>HD</sub>	V <sub>HD</sub> +0.050	V	2	2
Overcurrent 1 detection voltage V <sub>IOV1</sub> = 0.050 V to 0.300 V, 10 mV Step	V <sub>IOV1</sub>	—	V <sub>IOV1</sub> −0.015	V <sub>IOV1</sub>	V <sub>IOV1</sub> +0.015	V	3	2
Overcurrent 2 detection voltage	V <sub>IOV2</sub>	—	0.400	0.500	0.600	V	3	2
Load short-circuiting detection voltage	V <sub>SHORT</sub>	—	0.900	1.200	1.500	V	3	2
Charger detection voltage	V <sub>CHA</sub>	—	−1.0	−0.7	−0.4	V	4	2
<b>INPUT VOLTAGE, OPERATION VOLTAGE</b>								
Operation voltage between VDD and VSS	V <sub>DSOP1</sub>	Internal circuit operating voltage	1.5	—	8	V	—	—
Operation voltage between VDD and VM	V <sub>DSOP2</sub>	Internal circuit operating voltage	1.5	—	28	V	—	—
<b>CURRENT CONSUMPTION (with power-down function)</b>								
Current consumption in normal operation	I <sub>OPE</sub>	V <sub>DD</sub> = 3.5 V, V <sub>VM</sub> = 0 V	1.0	3.5	7.0	μA	5	2
Current consumption at power down	I <sub>PDN</sub>	V <sub>DD</sub> = V <sub>VM</sub> = 1.5 V	—	—	0.1	μA	5	2
<b>CURRENT CONSUMPTION (without power-down function)</b>								
Current consumption in normal operation	I <sub>OPE</sub>	V <sub>DD</sub> = 3.5 V, V <sub>VM</sub> = 0 V	1.0	3.5	7.0	μA	5	2
Overdischarge current consumption	I <sub>OPEd</sub>	V <sub>DD</sub> = V <sub>VM</sub> = 1.5 V	1.0	3.0	5.5	μA	5	2
<b>OUTPUT RESISTANCE</b>								
CO pin resistance "H"	R <sub>COH</sub>	V <sub>CO</sub> = 3.0 V, V <sub>DD</sub> = 3.5 V, V <sub>VM</sub> = 0 V	2.5	5	10	kΩ	7	4
CO pin resistance "L"	R <sub>COL</sub>	V <sub>CO</sub> = 0.5 V, V <sub>DD</sub> = 4.5 V, V <sub>VM</sub> = 0 V	2.5	5	10	kΩ	7	4
DO pin resistance "H"	R <sub>DOH</sub>	V <sub>DO</sub> = 3.0 V, V <sub>DD</sub> = 3.5 V, V <sub>VM</sub> = 0 V	2.5	5	10	kΩ	8	4
DO pin resistance "L"	R <sub>DOL</sub>	V <sub>DO</sub> = 0.5 V, V <sub>DD</sub> = V <sub>VM</sub> = 1.8 V	2.5	5	10	kΩ	8	4
<b>VM INTERNAL RESISTANCE</b>								
Internal resistance between VM and VDD	R <sub>VMD</sub>	V <sub>DD</sub> = 1.8 V, V <sub>VM</sub> = 0 V	100	300	900	kΩ	6	3
Internal resistance between VM and VSS	R <sub>VMS</sub>	V <sub>DD</sub> = 3.5 V, V <sub>VM</sub> = 1.0 V	10	20	40	kΩ	6	3
<b>0 V BATTERY CHARGE FUNCTION</b>								
0 V battery charge starting charger voltage	V <sub>OCHA</sub>	0 V battery charge "available"	1.2	—	—	V	11	2
0 V battery charge inhibition battery voltage	V <sub>OINH</sub>	0 V battery charge "unavailable"	—	—	0.5	V	12	2

\*1. Since products are not screened at high and low temperatures, the specification for this temperature range is guaranteed by design, not tested in production.



# BATTERY PROTECTION IC FOR 1-CELL PACK S-8261 Series

Rev.5.4\_02

## 2. Except Detection Delay Time (–40°C to +85°C\*1)

Table 7

(Ta = –40°C to +85°C\*1 unless otherwise specified)

Item	Symbol	Condition	Min.	Typ.	Max.	Unit	Test Condition	Test Circuit
<b>DETECTION VOLTAGE</b>								
Overcharge detection voltage V <sub>CU</sub> = 3.900 V to 4.500 V, 5 mV Step	V <sub>CU</sub>	—	V <sub>CU</sub> –0.055	V <sub>CU</sub>	V <sub>CU</sub> +0.040	V	1	1
Overcharge hysteresis voltage V <sub>HC</sub> = 0.1 V to 0.4 V, 50 mV Step	V <sub>HC</sub>	—	V <sub>HC</sub> –0.025	V <sub>HC</sub>	V <sub>HC</sub> +0.025	V	1	1
Overdischarge detection voltage V <sub>DL</sub> = 2.000 V to 3.000 V, 10 mV Step	V <sub>DL</sub>	—	V <sub>DL</sub> –0.080	V <sub>DL</sub>	V <sub>DL</sub> +0.080	V	2	2
Overdischarge hysteresis voltage V <sub>HD</sub> = 0.0 V to 0.7 V, 100 mV Step	V <sub>HD</sub>	—	V <sub>HD</sub> –0.050	V <sub>HD</sub>	V <sub>HD</sub> +0.050	V	2	2
Overcurrent 1 detection voltage V <sub>IOV1</sub> = 0.050 V to 0.300 V, 10 mV Step	V <sub>IOV1</sub>	—	V <sub>IOV1</sub> –0.021	V <sub>IOV1</sub>	V <sub>IOV1</sub> +0.021	V	3	2
Overcurrent 2 detection voltage	V <sub>IOV2</sub>	—	0.370	0.500	0.630	V	3	2
Load short-circuiting detection voltage	V <sub>SHORT</sub>	—	0.700	1.200	1.700	V	3	2
Charger detection voltage	V <sub>CHA</sub>	—	–1.2	–0.7	–0.2	V	4	2
<b>INPUT VOLTAGE, OPERATION VOLTAGE</b>								
Operation voltage between VDD and VSS	V <sub>DSOP1</sub>	Internal circuit operating voltage	1.5	—	8	V	—	—
Operation voltage between VDD and VM	V <sub>DSOP2</sub>	Internal circuit operating voltage	1.5	—	28	V	—	—
<b>CURRENT CONSUMPTION (with power-down function)</b>								
Current consumption in normal operation	I <sub>OPE</sub>	V <sub>DD</sub> = 3.5 V, V <sub>VM</sub> = 0 V	0.7	3.5	8.0	μA	5	2
Current consumption at power down	I <sub>PDN</sub>	V <sub>DD</sub> = V <sub>VM</sub> = 1.5 V	—	—	0.1	μA	5	2
<b>CURRENT CONSUMPTION (without power-down function)</b>								
Current consumption in normal operation	I <sub>OPE</sub>	V <sub>DD</sub> = 3.5 V, V <sub>VM</sub> = 0 V	0.7	3.5	8.0	μA	5	2
Overdischarge current consumption	I <sub>OPED</sub>	V <sub>DD</sub> = V <sub>VM</sub> = 1.5 V	0.7	3.0	6.0	μA	5	2
<b>OUTPUT RESISTANCE</b>								
CO pin resistance "H"	R <sub>COH</sub>	V <sub>CO</sub> = 3.0 V, V <sub>DD</sub> = 3.5 V, V <sub>VM</sub> = 0 V	1.2	5	15	kΩ	7	4
CO pin resistance "L"	R <sub>COL</sub>	V <sub>CO</sub> = 0.5 V, V <sub>DD</sub> = 4.5 V, V <sub>VM</sub> = 0 V	1.2	5	15	kΩ	7	4
DO pin resistance "H"	R <sub>DOH</sub>	V <sub>DO</sub> = 3.0 V, V <sub>DD</sub> = 3.5 V, V <sub>VM</sub> = 0 V	1.2	5	15	kΩ	8	4
DO pin resistance "L"	R <sub>DOL</sub>	V <sub>DO</sub> = 0.5 V, V <sub>DD</sub> = V <sub>VM</sub> = 1.8 V	1.2	5	15	kΩ	8	4
<b>VM INTERNAL RESISTANCE</b>								
Internal resistance between VM and VDD	R <sub>VMD</sub>	V <sub>DD</sub> = 1.8 V, V <sub>VM</sub> = 0 V	78	300	1310	kΩ	6	3
Internal resistance between VM and VSS	R <sub>VMS</sub>	V <sub>DD</sub> = 3.5 V, V <sub>VM</sub> = 1.0 V	7.2	20	44	kΩ	6	3
<b>0 V BATTERY CHARGE FUNCTION</b>								
0 V battery charge starting charger voltage	V <sub>OCHA</sub>	0 V battery charge "available"	1.7	—	—	V	11	2
0 V battery charge inhibition battery voltage	V <sub>OINH</sub>	0 V battery charge "unavailable"	—	—	0.3	V	12	2

\*1. Since products are not screened at high and low temperatures, the specification for this temperature range is guaranteed by design, not tested in production.

**3. Detection Delay Time**

- (1) S-8261AAG, S-8261AAH, S-8261AAJ, S-8261AAL, S-8261AAM, S-8261AAN, S-8261AAO, S-8261AAP, S-8261AAR, S-8261AAZ, S-8261ABB, S-8261ABC, S-8261ABJ, S-8261ABK, S-8261ABM, S-8261ABN, S-8261ABP, S-8261ABR, S-8261ABS, S-8261ACB, S-8261ACE, S-8261ACI, S-8261ACK, S-8261ACM, S-8261ACJ, S-8261ACN

**Table 8**

Item	Symbol	Condition	Min.	Typ.	Max.	Unit	Test Condition	Test Circuit
<b>DELAY TIME (Ta = 25°C)</b>								
Overcharge detection delay time	t <sub>CU</sub>	—	0.96	1.2	1.4	s	9	5
Overdischarge detection delay time	t <sub>DL</sub>	—	115	144	173	ms	9	5
Overcurrent 1 detection delay time	t <sub>OV1</sub>	—	7.2	9	11	ms	10	5
Overcurrent 2 detection delay time	t <sub>OV2</sub>	—	1.8	2.24	2.7	ms	10	5
Load short-circuiting detection delay time	t <sub>SHORT</sub>	—	220	320	380	μs	10	5
<b>DELAY TIME (Ta = -40°C to +85°C) *1</b>								
Overcharge detection delay time	t <sub>CU</sub>	—	0.7	1.2	2.0	s	9	5
Overdischarge detection delay time	t <sub>DL</sub>	—	80	144	245	ms	9	5
Overcurrent 1 detection delay time	t <sub>OV1</sub>	—	5	9	15	ms	10	5
Overcurrent 2 detection delay time	t <sub>OV2</sub>	—	1.2	2.24	3.8	ms	10	5
Load short-circuiting detection delay time	t <sub>SHORT</sub>	—	150	320	540	μs	10	5

\*1. Since products are not screened at high and low temperatures, the specification for this temperature range is guaranteed by design, not tested in production.

- (2) S-8261AAS

**Table 9**

Item	Symbol	Condition	Min.	Typ.	Max.	Unit	Test Condition	Test Circuit
<b>DELAY TIME (Ta = 25°C)</b>								
Overcharge detection delay time	t <sub>CU</sub>	—	0.96	1.2	1.4	s	9	5
Overdischarge detection delay time	t <sub>DL</sub>	—	115	144	173	ms	9	5
Overcurrent 1 detection delay time	t <sub>OV1</sub>	—	3.6	4.5	5.4	ms	10	5
Overcurrent 2 detection delay time	t <sub>OV2</sub>	—	1.8	2.24	2.7	ms	10	5
Load short-circuiting detection delay time	t <sub>SHORT</sub>	—	220	320	380	μs	10	5
<b>DELAY TIME (Ta = -40°C to +85°C) *1</b>								
Overcharge detection delay time	t <sub>CU</sub>	—	0.7	1.2	2.0	s	9	5
Overdischarge detection delay time	t <sub>DL</sub>	—	80	144	245	ms	9	5
Overcurrent 1 detection delay time	t <sub>OV1</sub>	—	2.5	4.5	7.7	ms	10	5
Overcurrent 2 detection delay time	t <sub>OV2</sub>	—	1.2	2.24	3.8	ms	10	5
Load short-circuiting detection delay time	t <sub>SHORT</sub>	—	150	320	540	μs	10	5

\*1. Since products are not screened at high and low temperatures, the specification for this temperature range is guaranteed by design, not tested in production.

**(3) S-8261AAT****Table 10**

Item	Symbol	Condition	Min.	Typ.	Max.	Unit	Test Condition	Test Circuit
<b>DELAY TIME (Ta = 25°C)</b>								
Overcharge detection delay time	t <sub>CU</sub>	—	3.7	4.6	5.5	s	9	5
Overdischarge detection delay time	t <sub>DL</sub>	—	29	36	43	ms	9	5
Overcurrent 1 detection delay time	t <sub>IOV1</sub>	—	14	18	22	ms	10	5
Overcurrent 2 detection delay time	t <sub>IOV2</sub>	—	7.2	9	11	ms	10	5
Load short-circuiting detection delay time	t <sub>SHORT</sub>	—	220	320	380	μs	10	5
<b>DELAY TIME (Ta = -40°C to +85°C) **1</b>								
Overcharge detection delay time	t <sub>CU</sub>	—	2.5	4.6	7.8	s	9	5
Overdischarge detection delay time	t <sub>DL</sub>	—	20	36	61	ms	9	5
Overcurrent 1 detection delay time	t <sub>IOV1</sub>	—	10	18	31	ms	10	5
Overcurrent 2 detection delay time	t <sub>IOV2</sub>	—	5	9	15	ms	10	5
Load short-circuiting detection delay time	t <sub>SHORT</sub>	—	150	320	540	μs	10	5

\*1. Since products are not screened at high and low temperatures, the specification for this temperature range is guaranteed by design, not tested in production.

**(4) S-8261AAU, S-8261AAX, S-8261ABA****Table 11**

Item	Symbol	Condition	Min.	Typ.	Max.	Unit	Test Condition	Test Circuit
<b>DELAY TIME (Ta = 25°C)</b>								
Overcharge detection delay time	t <sub>CU</sub>	—	3.7	4.6	5.5	s	9	5
Overdischarge detection delay time	t <sub>DL</sub>	—	115	144	173	ms	9	5
Overcurrent 1 detection delay time	t <sub>IOV1</sub>	—	7.2	9	11	ms	10	5
Overcurrent 2 detection delay time	t <sub>IOV2</sub>	—	1.8	2.24	2.7	ms	10	5
Load short-circuiting detection delay time	t <sub>SHORT</sub>	—	220	320	380	μs	10	5
<b>DELAY TIME (Ta = -40°C to +85°C) **1</b>								
Overcharge detection delay time	t <sub>CU</sub>	—	2.5	4.6	7.8	s	9	5
Overdischarge detection delay time	t <sub>DL</sub>	—	80	144	245	ms	9	5
Overcurrent 1 detection delay time	t <sub>IOV1</sub>	—	5	9	15	ms	10	5
Overcurrent 2 detection delay time	t <sub>IOV2</sub>	—	1.2	2.24	3.8	ms	10	5
Load short-circuiting detection delay time	t <sub>SHORT</sub>	—	150	320	540	μs	10	5

\*1. Since products are not screened at high and low temperatures, the specification for this temperature range is guaranteed by design, not tested in production.

(5) S-8261ABI, S-8261ABL, S-8261ABT

**Table 12**

Item	Symbol	Condition	Min.	Typ.	Max.	Unit	Test condition	Test circuit
<b>DELAY TIME (Ta = 25°C)</b>								
Overcharge detection delay time	t <sub>CU</sub>	—	0.96	1.2	1.4	s	9	5
Overdischarge detection delay time	t <sub>DL</sub>	—	29	36	43	ms	9	5
Overcurrent 1 detection delay time	t <sub>IOV1</sub>	—	7.2	9	11	ms	10	5
Overcurrent 2 detection delay time	t <sub>IOV2</sub>	—	1.8	2.24	2.7	ms	10	5
Load short-circuiting detection delay time	t <sub>SHORT</sub>	—	220	320	380	μs	10	5
<b>DELAY TIME (Ta = -40°C to +85°C) **1</b>								
Overcharge detection delay time	t <sub>CU</sub>	—	0.7	1.2	2.0	s	9	5
Overdischarge detection delay time	t <sub>DL</sub>	—	20	36	61	ms	9	5
Overcurrent 1 detection delay time	t <sub>IOV1</sub>	—	5	9	15	ms	10	5
Overcurrent 2 detection delay time	t <sub>IOV2</sub>	—	1.2	2.24	3.8	ms	10	5
Load short-circuiting detection delay time	t <sub>SHORT</sub>	—	150	320	540	μs	10	5

\*1. Since products are not screened at high and low temperatures, the specification for this temperature range is guaranteed by design, not tested in production.

(6) S-8261ABY, S-8261ABZ, S-8261ACA, S-8261ACS

**Table 13**

Item	Symbol	Condition	Min.	Typ.	Max.	Unit	Test Condition	Test Circuit
<b>DELAY TIME (Ta = 25°C)</b>								
Overcharge detection delay time	t <sub>CU</sub>	—	0.96	1.2	1.4	s	9	5
Overdischarge detection delay time	t <sub>DL</sub>	—	115	144	173	ms	9	5
Overcurrent 1 detection delay time	t <sub>IOV1</sub>	—	7.2	9	11	ms	10	5
Overcurrent 2 detection delay time	t <sub>IOV2</sub>	—	0.89	1.12	1.35	ms	10	5
Load short-circuiting detection delay time	t <sub>SHORT</sub>	—	220	320	380	μs	10	5
<b>DELAY TIME (Ta = -40°C to +85°C) **1</b>								
Overcharge detection delay time	t <sub>CU</sub>	—	0.7	1.2	2.0	s	9	5
Overdischarge detection delay time	t <sub>DL</sub>	—	80	144	245	ms	9	5
Overcurrent 1 detection delay time	t <sub>IOV1</sub>	—	5	9	15	ms	10	5
Overcurrent 2 detection delay time	t <sub>IOV2</sub>	—	0.61	1.12	1.91	ms	10	5
Load short-circuiting detection delay time	t <sub>SHORT</sub>	—	150	320	540	μs	10	5

\*1. Since products are not screened at high and low temperatures, the specification for this temperature range is guaranteed by design, not tested in production.

**(7) S-8261ACD****Table 14**

Item	Symbol	Condition	Min.	Typ.	Max.	Unit	Test Condition	Test Circuit
<b>DELAY TIME (Ta = 25°C)</b>								
Overcharge detection delay time	t <sub>CU</sub>	—	0.96	1.2	1.4	s	9	5
Overdischarge detection delay time	t <sub>DL</sub>	—	232	290	348	ms	9	5
Overcurrent 1 detection delay time	t <sub>IOV1</sub>	—	14	18	22	ms	10	5
Overcurrent 2 detection delay time	t <sub>IOV2</sub>	—	1.8	2.24	2.7	ms	10	5
Load short-circuiting detection delay time	t <sub>SHORT</sub>	—	220	320	380	μs	10	5
<b>DELAY TIME (Ta = -40°C to +85°C) **1</b>								
Overcharge detection delay time	t <sub>CU</sub>	—	0.7	1.2	2.0	s	9	5
Overdischarge detection delay time	t <sub>DL</sub>	—	160	290	493	ms	9	5
Overcurrent 1 detection delay time	t <sub>IOV1</sub>	—	10	18	31	ms	10	5
Overcurrent 2 detection delay time	t <sub>IOV2</sub>	—	1.2	2.24	3.8	ms	10	5
Load short-circuiting detection delay time	t <sub>SHORT</sub>	—	150	320	540	μs	10	5

\*1. Since products are not screened at high and low temperatures, the specification for this temperature range is guaranteed by design, not tested in production.

**(8) S-8261ACF****Table 15**

Item	Symbol	Condition	Min.	Typ.	Max.	Unit	Test Condition	Test Circuit
<b>DELAY TIME (Ta = 25°C)</b>								
Overcharge detection delay time	t <sub>CU</sub>	—	0.96	1.2	1.4	s	9	5
Overdischarge detection delay time	t <sub>DL</sub>	—	115	144	173	ms	9	5
Overcurrent 1 detection delay time	t <sub>IOV1</sub>	—	14	18	22	ms	10	5
Overcurrent 2 detection delay time	t <sub>IOV2</sub>	—	1.8	2.24	2.7	ms	10	5
Load short-circuiting detection delay time	t <sub>SHORT</sub>	—	220	320	380	μs	10	5
<b>DELAY TIME (Ta = -40°C to +85°C) **1</b>								
Overcharge detection delay time	t <sub>CU</sub>	—	0.7	1.2	2.0	s	9	5
Overdischarge detection delay time	t <sub>DL</sub>	—	80	144	245	ms	9	5
Overcurrent 1 detection delay time	t <sub>IOV1</sub>	—	10	18	31	ms	10	5
Overcurrent 2 detection delay time	t <sub>IOV2</sub>	—	1.2	2.24	3.8	ms	10	5
Load short-circuiting detection delay time	t <sub>SHORT</sub>	—	150	320	540	μs	10	5

\*1. Since products are not screened at high and low temperatures, the specification for this temperature range is guaranteed by design, not tested in production.

(9) S-8261ACH

**Table 16**

Item	Symbol	Condition	Min.	Typ.	Max.	Unit	Test Condition	Test Circuit
<b>DELAY TIME (Ta = 25°C)</b>								
Overcharge detection delay time	t <sub>CU</sub>	—	0.24	0.3	0.36	s	9	5
Overdischarge detection delay time	t <sub>DL</sub>	—	29	36	43	ms	9	5
Overcurrent 1 detection delay time	t <sub>IOV1</sub>	—	7.2	9	11	ms	10	5
Overcurrent 2 detection delay time	t <sub>IOV2</sub>	—	0.89	1.12	1.35	ms	10	5
Load short-circuiting detection delay time	t <sub>SHORT</sub>	—	220	320	380	μs	10	5
<b>DELAY TIME (Ta = -40°C to +85°C) **1</b>								
Overcharge detection delay time	t <sub>CU</sub>	—	0.17	0.3	0.51	s	9	5
Overdischarge detection delay time	t <sub>DL</sub>	—	20	36	61	ms	9	5
Overcurrent 1 detection delay time	t <sub>IOV1</sub>	—	5	9	15	ms	10	5
Overcurrent 2 detection delay time	t <sub>IOV2</sub>	—	0.61	1.12	1.91	ms	10	5
Load short-circuiting detection delay time	t <sub>SHORT</sub>	—	150	320	540	μs	10	5

\*1. Since products are not screened at high and low temperatures, the specification for this temperature range is guaranteed by design, not tested in production.

## ■ Test Circuits

**Caution** Unless otherwise specified, the output voltage levels “H” and “L” at CO pin ( $V_{CO}$ ) and DO pin ( $V_{DO}$ ) are judged by the threshold voltage (1.0 V) of the N-channel FET. Judge the CO pin level with respect to  $V_{VM}$  and the DO pin level with respect to  $V_{SS}$ .

### (1) Test Condition 1, Test Circuit 1

#### (Overcharge Detection Voltage, Overcharge Hysteresis Voltage)

The overcharge detection voltage ( $V_{CU}$ ) is defined as the voltage between VDD and VSS at which  $V_{CO}$  goes from “H” to “L” when the voltage  $V_1$  is gradually increased from the starting condition of  $V_1 = 3.5$  V. The overcharge hysteresis voltage ( $V_{HC}$ ) is then defined as the difference between the overcharge detection voltage ( $V_{CU}$ ) and the voltage between VDD and VSS at which  $V_{CO}$  goes from “L” to “H” when the voltage  $V_1$  is gradually decreased.

### (2) Test Condition 2, Test Circuit 2

#### (Overdischarge Detection Voltage, Overdischarge Hysteresis Voltage)

The overdischarge detection voltage ( $V_{DL}$ ) is defined as the voltage between VDD and VSS at which  $V_{DO}$  goes from “H” to “L” when the voltage  $V_1$  is gradually decreased from the starting condition of  $V_1 = 3.5$  V and  $V_2 = 0$  V. The overdischarge hysteresis voltage ( $V_{HD}$ ) is then defined as the difference between the overdischarge detection voltage ( $V_{DL}$ ) and the voltage between VDD and VSS at which  $V_{DO}$  goes from “L” to “H” when the voltage  $V_1$  is gradually increased.

### (3) Test Condition 3, Test Circuit 2

#### (Overcurrent 1 Detection Voltage, Overcurrent 2 Detection Voltage, Load Short-Circuiting Detection Voltage)

The overcurrent 1 detection voltage ( $V_{IOV1}$ ) is defined as the voltage between VM and VSS whose delay time for changing  $V_{DO}$  from “H” to “L” lies between the minimum and the maximum value of the overcurrent 1 detection delay time when the voltage  $V_2$  is increased rapidly (within 10  $\mu$ s) from the starting condition  $V_1 = 3.5$  V and  $V_2 = 0$  V.

The overcurrent 2 detection voltage ( $V_{IOV2}$ ) is defined as the voltage between VM and VSS whose delay time for changing  $V_{DO}$  from “H” to “L” lies between the minimum and the maximum value of the overcurrent 2 detection delay time when the voltage  $V_2$  is increased rapidly (within 10  $\mu$ s) from the starting condition  $V_1 = 3.5$  V and  $V_2 = 0$  V.

The load short-circuiting detection voltage ( $V_{SHORT}$ ) is defined as the voltage between VM and VSS whose delay time for changing  $V_{DO}$  from “H” to “L” lies between the minimum and the maximum value of the load short-circuiting detection delay time when the voltage  $V_2$  is increased rapidly (within 10  $\mu$ s) from the starting condition  $V_1 = 3.5$  V and  $V_2 = 0$  V.

### (4) Test Condition 4, Test Circuit 2

#### (Charger Detection Voltage, Abnormal Charge Current Detection Voltage)

The charger detection voltage ( $V_{CHA}$ ) is defined as the voltage between VM and VSS at which  $V_{DO}$  goes from “L” to “H” when the voltage  $V_2$  is gradually decreased from 0 V after the voltage  $V_1$  is gradually increased from the starting condition of  $V_1 = 1.8$  V and  $V_2 = 0$  V until the voltage  $V_1$  becomes  $V_1 = V_{DL} + (V_{HD} / 2)$ .

The charger detection voltage can be measured only in the product whose overdischarge hysteresis  $V_{HD} \neq 0$ .

Set  $V_1 = 3.5$  V and  $V_2 = 0$  V. Decrease  $V_2$  from 0 V gradually. The voltage between VM and VSS when  $V_{CO}$  goes from “H” to “L” is the abnormal charge current detection voltage. The abnormal charge current detection voltage has the same value as the charger detection voltage ( $V_{CHA}$ ).

### (5) Test Condition 5, Test Circuit 2

#### (Normal Operation Current Consumption, Power-Down Current Consumption, Overdischarge Current Consumption)

##### With power-down function

The operating current consumption ( $I_{OPE}$ ) is the current that flows through the VDD pin ( $I_{DD}$ ) under the set conditions of  $V_1 = 3.5$  V and  $V_2 = 0$  V (Normal status).

The power-down current consumption ( $I_{PDN}$ ) is the current that flows through the VDD pin ( $I_{DD}$ ) under the set conditions of  $V_1 = V_2 = 1.5$  V (Overdischarge status).

##### Without power-down function

The operating current consumption ( $I_{OPE}$ ) is the current that flows through the VDD pin ( $I_{DD}$ ) under the set conditions of  $V_1 = 3.5$  V and  $V_2 = 0$  V (Normal status).

The Overdischarge current consumption ( $I_{OPED}$ ) is the current that flows through the VDD pin ( $I_{DD}$ ) under the set conditions of  $V_1 = V_2 = 1.5$  V (Overdischarge status).

**(6) Test Condition 6, Test Circuit 3**

**(Internal Resistance between VM and VDD, Internal Resistance between VM and VSS)**

The resistance between VM and VDD ( $R_{VMD}$ ) is the internal resistance between VM and VDD under the set conditions of  $V1 = 1.8\text{ V}$  and  $V2 = 0\text{ V}$ .

The resistance between VM and VSS ( $R_{VMS}$ ) is the internal resistance between VM and VSS under the set conditions of  $V1 = 3.5\text{ V}$  and  $V2 = 1.0\text{ V}$ .

**(7) Test Condition 7, Test Circuit 4**

**(CO Pin Resistance “H”, CO Pin Resistance “L”)**

The CO pin resistance “H” ( $R_{COH}$ ) is the resistance the CO pin under the set condition of  $V1 = 3.5\text{ V}$ ,  $V2 = 0\text{ V}$  and  $V3 = 3.0\text{ V}$ .

The CO pin resistance “L” ( $R_{COL}$ ) is the resistance the CO pin under the set condition of  $V1 = 4.5\text{ V}$ ,  $V2 = 0\text{ V}$  and  $V3 = 0.5\text{ V}$ .

**(8) Test Condition 8, Test Circuit 4**

**(DO Pin Resistance “H”, DO Pin Resistance “L”)**

The DO pin resistance “H” ( $R_{DOH}$ ) is the resistance the DO pin under the set condition of  $V1 = 3.5\text{ V}$ ,  $V2 = 0\text{ V}$  and  $V4 = 3.0\text{ V}$ .

The DO pin resistance “L” ( $R_{DOL}$ ) is the resistance the DO pin under the set condition of  $V1 = 1.8\text{ V}$ ,  $V2 = 0\text{ V}$  and  $V4 = 0.5\text{ V}$ .

**(9) Test Condition 9, Test Circuit 5**

**(Overcharge Detection Delay Time, Overdischarge Detection Delay Time)**

The overcharge detection delay time ( $t_{CU}$ ) is the time needed for  $V_{CO}$  to change from “H” to “L” just after the voltage  $V1$  momentarily increases (within  $10\text{ }\mu\text{s}$ ) from the overcharge detection voltage ( $V_{CU}$ ) –  $0.2\text{ V}$  to the overcharge detection voltage ( $V_{CU}$ ) +  $0.2\text{ V}$  under the set condition of  $V2 = 0\text{ V}$ .

The overdischarge detection delay time ( $t_{DL}$ ) is the time needed for  $V_{DO}$  to change from “H” to “L” just after the voltage  $V1$  momentarily decreases (within  $10\text{ }\mu\text{s}$ ) from the overdischarge detection voltage ( $V_{DL}$ ) +  $0.2\text{ V}$  to the overdischarge detection voltage ( $V_{DL}$ ) –  $0.2\text{ V}$  under the set condition of  $V2 = 0\text{ V}$ .

**(10) Test Condition 10, Test Circuit 5**

**(Overcurrent 1 Detection Delay Time, Overcurrent 2 Detection Delay Time, Load Short-circuiting Detection Delay Time, Abnormal Charge Current Detection Delay Time)**

The overcurrent 1 detection delay time ( $t_{IOV1}$ ) is the time needed for  $V_{DO}$  to go “L” after the voltage  $V2$  momentarily increases (within  $10\text{ }\mu\text{s}$ ) from  $0\text{ V}$  to  $0.35\text{ V}$  under the set condition of  $V1 = 3.5\text{ V}$  and  $V2 = 0\text{ V}$ .

The overcurrent 2 detection delay time ( $t_{IOV2}$ ) is the time needed for  $V_{DO}$  to go “L” after the voltage  $V2$  momentarily increases (within  $10\text{ }\mu\text{s}$ ) from  $0\text{ V}$  to  $0.7\text{ V}$  under the set condition of  $V1 = 3.5\text{ V}$  and  $V2 = 0\text{ V}$ .

The load short-circuiting detection delay time ( $t_{SHORT}$ ) is the time needed for  $V_{DO}$  to go “L” after the voltage  $V2$  momentarily increases (within  $10\text{ }\mu\text{s}$ ) from  $0\text{ V}$  to  $1.6\text{ V}$  under the set condition of  $V1 = 3.5\text{ V}$  and  $V2 = 0\text{ V}$ .

The abnormal charge current detection delay time is the time needed for  $V_{CO}$  to go from “H” to “L” after the voltage  $V2$  momentarily decreases (within  $10\text{ }\mu\text{s}$ ) from  $0\text{ V}$  to  $-1.1\text{ V}$  under the set condition of  $V1 = 3.5\text{ V}$  and  $V2 = 0\text{ V}$ . The abnormal charge current detection delay time has the same value as the overcharge detection delay time.

**(11) Test Condition 11, Test Circuit 2 (0 V battery charge function)**

**(0 V Battery Charge Starting Charger Voltage)**

The 0 V battery charge starting charger voltage ( $V_{0CHA}$ ) is defined as the voltage between VDD and VM at which  $V_{CO}$  goes “H” ( $V_{VM} + 0.1\text{ V}$  or higher) when the voltage  $V2$  is gradually decreased from the starting condition of  $V1 = V2 = 0\text{ V}$ .

**(12) Test Condition 12, Test Circuit 2 (0 V battery charge inhibition function)**

**(0 V Battery Charge Inhibition Battery Voltage)**

The 0 V battery charge inhibition battery voltage ( $V_{0INH}$ ) is defined as the voltage between VDD and VSS at which  $V_{CO}$  goes “H” ( $V_{VM} + 0.1\text{ V}$  or higher) when the voltage  $V1$  is gradually increased from the starting condition of  $V1 = 0\text{ V}$  and  $V2 = -4\text{ V}$ .



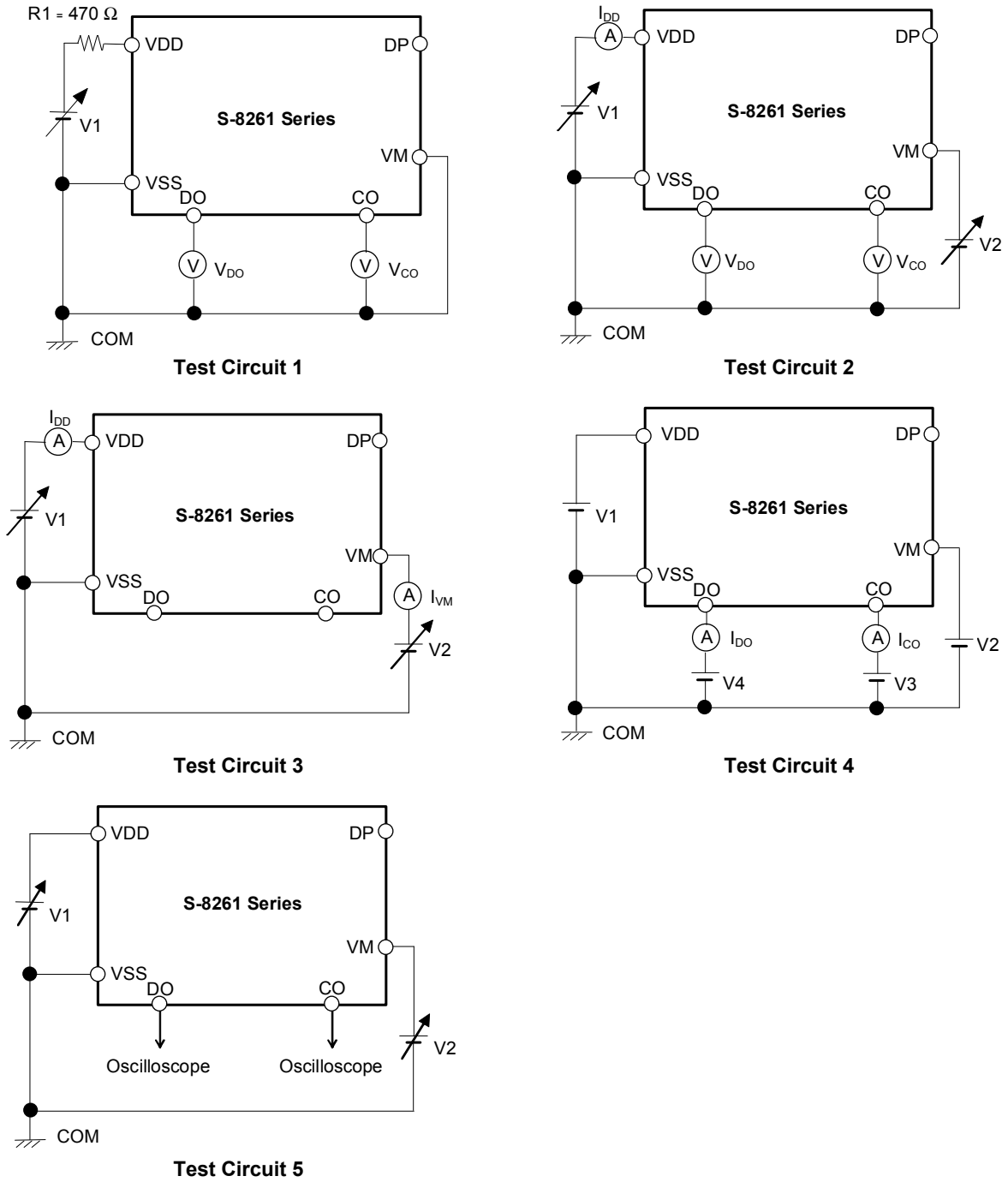

Figure 4

## ■ Operation

**Remark** Refer to “■ Battery Protection IC Connection Example”.

### 1. Normal Status

The S-8261 Series monitors the voltage of the battery connected between VDD pin and VSS pin and the voltage difference between VM pin and VSS pin to control charging and discharging. When the battery voltage is in the range from the overdischarge detection voltage ( $V_{DL}$ ) to the overcharge detection voltage ( $V_{CU}$ ), and the VM pin voltage is in the range from the charger detection voltage ( $V_{CHA}$ ) to the overcurrent 1 detection voltage ( $V_{IOV1}$ ), the IC turns both the charging and discharging control FETs on. This status is called the normal status, and in this status charging and discharging can be carried out freely.

**Caution** When a battery is connected to the IC for the first time, discharging may not be enabled. In this case, short the VM pin and VSS pin or connect the charger to restore the normal condition.

### 2. Overcurrent Status (Detection of Overcurrent 1, Overcurrent 2 and Load Short-circuiting)

When a battery in the normal status is in the status where the voltage of the VM pin is equal to or higher than the overcurrent detection voltage because the discharge current is higher than the specified value and the status lasts for the overcurrent detection delay time, the discharge control FET is turned off and discharging is stopped. This status is called the overcurrent status.

In the overcurrent status, the VM and VSS pins are shorted by the resistor between VM and VSS ( $R_{VMS}$ ) in the IC. However, the voltage of the VM pin is at the  $V_{DD}$  potential due to the load as long as the load is connected. When the load is disconnected completely, the VM pin returns to the  $V_{SS}$  potential.

The voltage of the VM pin returns to overcurrent 1 detection voltage ( $V_{IOV1}$ ) or lower and the overcurrent status is restored to the normal status.

### 3. Overcharge Status

When the battery voltage becomes higher than the overcharge detection voltage ( $V_{CU}$ ) during charging under the normal status and the detection continues for the overcharge detection delay time ( $t_{CU}$ ) or longer, the S-8261 Series turns the charging control FET off to stop charging. This status is called the overcharge status.

The overcharge status is released by the following two cases ((1) and (2)):

- (1) When the battery voltage falls below the overcharge detection voltage ( $V_{CU}$ ) – overcharge hysteresis voltage ( $V_{HC}$ ), the S-8261 Series turns the charging control FET on and turns to the normal status.
- (2) When a load is connected and discharging starts, the S-8261 Series turns the charging control FET on and returns to the normal status. Just after the load is connected and discharging starts, the discharging current flows through the parasitic diode in the charging control FET. At this moment the VM pin potential becomes  $V_f$ , the voltage for the parasitic diode, higher than  $V_{SS}$  level. When the battery voltage goes under the overcharge detection voltage ( $V_{CU}$ ) and provided that the VM pin voltage is higher than the overcurrent 1 detection voltage, the S-8261 Series releases the overcharge status.

**Caution 1.** If the battery is charged to a voltage higher than the overcharge detection voltage ( $V_{CU}$ ) and the battery voltage does not fall below the overcharge detection voltage ( $V_{CU}$ ) even when a heavy load is connected, the detection of overcurrent 1, overcurrent 2 and load short-circuiting do not function until the battery voltage falls below overcharge detection voltage ( $V_{CU}$ ). Since an actual battery has an internal impedance of several dozens of  $m\Omega$ , the battery voltage drops immediately after a heavy load that causes overcurrent is connected, and the detection of overcurrent 1, overcurrent 2 and load short-circuiting function.

2. When a charger is connected after the overcharge detection, the overcharge status is not released even if the battery voltage is below the overcharge release voltage ( $V_{CL}$ ). The overcharge status is released when the VM pin voltage goes over the charger detection voltage ( $V_{CHA}$ ) by removing the charger.

#### 4. Overdischarge Status

##### With power-down function

When the battery voltage falls below the overdischarge detection voltage ( $V_{DL}$ ) during discharging under the normal status and the detection continues for the overdischarge detection delay time ( $t_{DL}$ ) or longer, the S-8261 Series turns the discharging control FET off to stop discharging. This status is called the overdischarge status. When the discharging control FET is turned off, the VM pin voltage is pulled up by the resistor between VM and VDD in the IC ( $R_{VMD}$ ). When the voltage difference between the VM and VDD then is 1.3 V (typ.) or lower, the current consumption is reduced to the power-down current consumption ( $I_{PDN}$ ). This status is called the power-down status.

The power-down status is released when a charger is connected and the voltage difference between the VM and VDD becomes 1.3 V (typ.) or higher. Moreover when the battery voltage becomes the overdischarge detection voltage ( $V_{DL}$ ) or higher, the S-8261 Series turns the discharging FET on and returns to the normal status.

##### Without power-down function

When the battery voltage falls below the overdischarge detection voltage ( $V_{DL}$ ) during discharging under the normal status and the detection continues for the overdischarge detection delay time ( $t_{DL}$ ) or longer, the S-8261 Series turns the discharging control FET off to stop discharging. This status is called the overdischarge status. When the discharging control FET is turned off, the VM pin voltage is pulled up by the resistor between VM and VDD in the IC ( $R_{VMD}$ ).

When the battery voltage becomes the overdischarge detection voltage ( $V_{DL}$ ) + overdischarge hysteresis voltage ( $V_{HD}$ ) or higher, the S-8261 Series turns the discharging FET on and returns to the normal status.

#### 5. Charger Detection

When a battery in the overdischarge status is connected to a charger and provided that the VM pin voltage is lower than the charger detection voltage ( $V_{CHA}$ ), the S-8261 Series releases the overdischarge status and turns the discharging control FET on when the battery voltage becomes equal to or higher than the overdischarge detection voltage ( $V_{DL}$ ) since the charger detection function works. This action is called charger detection.

When a battery in the overdischarge status is connected to a charger and provided that the VM pin voltage is not lower than the charger detection voltage ( $V_{CHA}$ ), the S-8261 Series releases the overdischarge status when the battery voltage reaches the overdischarge detection voltage ( $V_{DL}$ ) + overdischarge hysteresis voltage ( $V_{HD}$ ) or higher.

#### 6. Abnormal Charge Current Detection

If the VM pin voltage falls below the charger detection voltage ( $V_{CHA}$ ) during charging under normal status and it continues for the overcharge detection delay time ( $t_{CU}$ ) or longer, the charging control FET turns off and charging stops. This action is called the abnormal charge current detection.

Abnormal charge current detection works when the DO pin voltage is "H" and the VM pin voltage falls below the charger detection voltage ( $V_{CHA}$ ). Consequently, if an abnormal charge current flows to an over-discharged battery, the S-8261 Series turns the charging control FET off and stops charging after the battery voltage becomes higher than the overdischarge detection voltage which make the DO pin voltage "H", and still after the overcharge detection delay time ( $t_{CU}$ ) elapses.

Abnormal charge current detection is released when the voltage difference between VM pin and VSS pin becomes less than charger detection voltage ( $V_{CHA}$ ).

**7. Delay Circuit**

The detection delay times are determined by dividing a clock of the approximately 3.5 kHz with the counter.

**Remark 1.** The detection delay time for overcurrent 2 ( $t_{IOV2}$ ) and load short-circuiting ( $t_{SHORT}$ ) start when the overcurrent 1 ( $V_{IOV1}$ ) is detected. When the overcurrent 2 ( $V_{IOV2}$ ) or load short-circuiting ( $V_{SHORT}$ ) is detected over the detection delay time for each of them ( $= t_{IOV2}$  or  $t_{SHORT}$ ) after the detection of overcurrent 1 ( $V_{IOV1}$ ), the S-8261 Series turns the FET off within  $t_{IOV2}$  or  $t_{SHORT}$  of each detection.

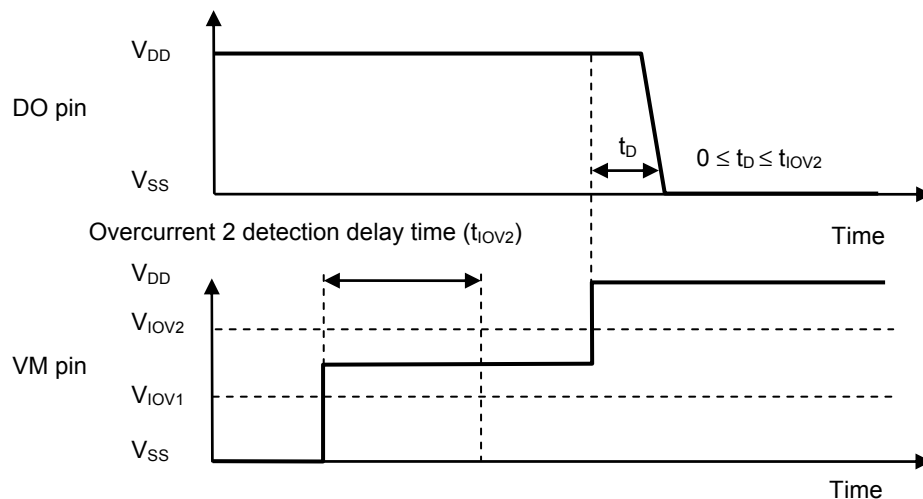

**Figure 5**

**2. With power-down function**

When the overcurrent is detected and continues for longer than the overdischarge detection delay time ( $t_{DL}$ ) without releasing the load, the status changes to the power-down status when the battery voltage falls below the overdischarge detection voltage ( $V_{DL}$ ). When the battery voltage falls below the overdischarge detection voltage ( $V_{DL}$ ) due to the overcurrent, the S-8261 Series turns the discharging control FET off by the overcurrent detection. In this case if the recovery of the battery voltage is so slow that the battery voltage after the overdischarge detection delay time ( $t_{DL}$ ) is still lower than the overdischarge detection voltage ( $V_{DL}$ ), the S-8261 Series shifts to the power-down status.

**Without power-down function**

When the overcurrent is detected and continues for longer than the overdischarge detection delay time ( $t_{DL}$ ) without released the load, the status changes to the overdischarge status when the battery voltage falls below overdischarge detection voltage ( $V_{DL}$ ).When the battery voltage falls below overdischarge detection voltage ( $V_{DL}$ ) due to the overcurrent, the S-8261 Series turns the discharging control FET off by the overcurrent detection. In this case, if the recovery of the battery voltage is so slow that the battery voltage after the overdischarge detection delay time ( $t_{DL}$ ) is still lower than the overdischarge detection voltage ( $V_{DL}$ ), the S-8261 Series shifts to the overdischarge status.

## 8. DP Pin

The DP pin is a test pin for delay time measurement and it should be open in the actual application. If a capacitor whose capacitance is larger than 1000 pF or a resistor whose resistance is less than 1 MΩ is connected to this pin, error may occur in the delay times or in the detection voltages.

## 9. 0 V Battery Charge Function “Available”

This function is used to recharge the connected battery whose voltage is 0 V due to the self-discharge. When the 0 V battery charge starting charger voltage ( $V_{0CHA}$ ) or higher is applied between EB+ pin and EB- pin by connecting a charger, the charging control FET gate is fixed to VDD pin voltage. When the voltage between the gate and source of the charging control FET becomes equal to or higher than the turn-on voltage due to the charger voltage, the charging control FET is turned on to start charging. At this time, the discharging control FET is off and the charging current flows through the internal parasitic diode in the discharging control FET. When the battery voltage becomes equal to or higher than the overdischarge detection voltage ( $V_{DL}$ ) and the overdischarge hysteresis voltage ( $V_{HD}$ ), the S-8261 Series enters the normal status.

**Caution** Some battery providers do not recommend charging for completely self-discharged battery. Please ask battery providers before determine whether to enable or inhibit the 0 V battery charge function.

**Remark** The 0 V battery charge function has higher priority than the abnormal charge current detection function. Consequently, a product with the 0 V battery charging function is enabled charges a battery forcibly and abnormal charge current cannot be detected when the battery voltage is low.

## 10. 0 V Battery Charge Function “Unavailable”

This function inhibits the recharging when a battery that is short-circuited (0 V battery) internally is connected. When the battery voltage is the 0 V battery charge inhibition battery voltage ( $V_{0INH}$ ) or lower, the charging control FET gate is fixed to EB- pin voltage to inhibit charging. When the battery voltage is the 0 V battery charge inhibition battery voltage ( $V_{0INH}$ ) or higher, charging can be performed.

**Caution** Some battery providers do not recommend charging for completely self-discharged battery. Please ask battery providers before determining the 0 V battery charge function.

■ **Timing Chart**

**(1) Overcharge and Overdischarge Detection**

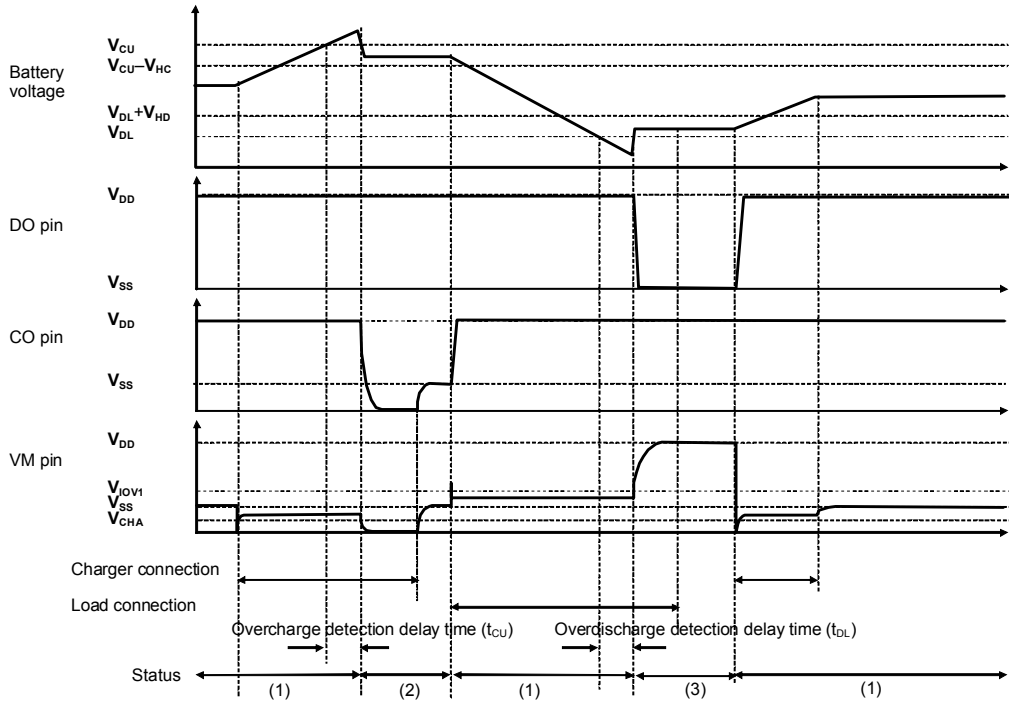

**Remark** (1) Normal status, (2) Overcharge status, (3) Overdischarge status, (4) Overcurrent status  
 The charger is supposed to charge with constant current.

**Figure 6**

**(2) Overcurrent Detection**

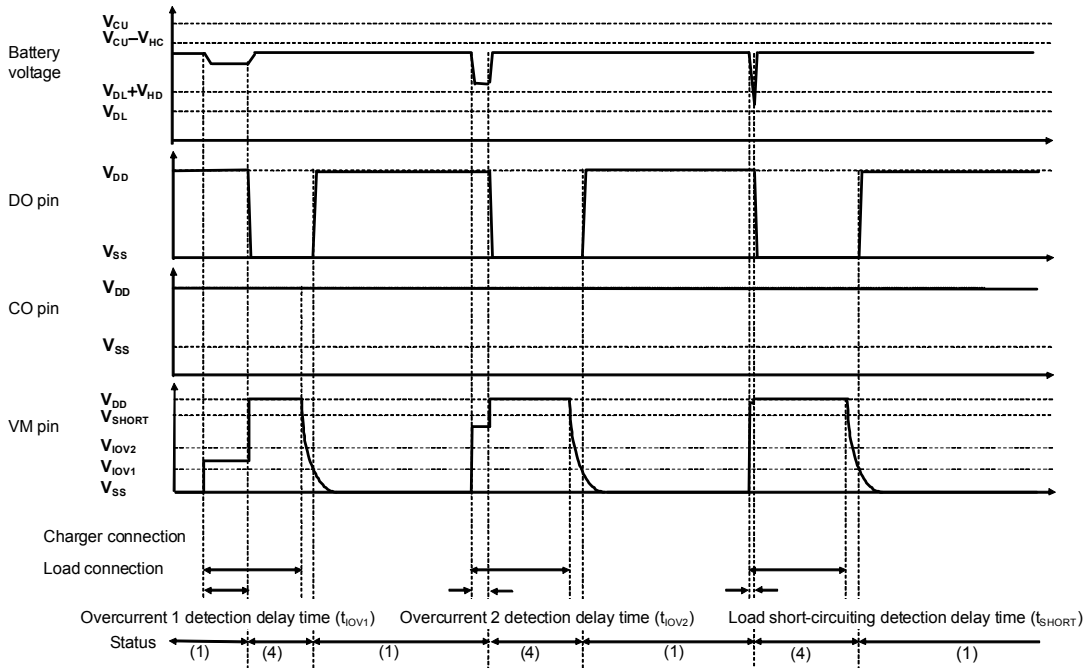

**Remark** (1) Normal status, (2) Overcharge status, (3) Overdischarge status, (4) Overcurrent status  
 The charger is supposed to charge with constant current.

**Figure 7**

(3) Charger Detection

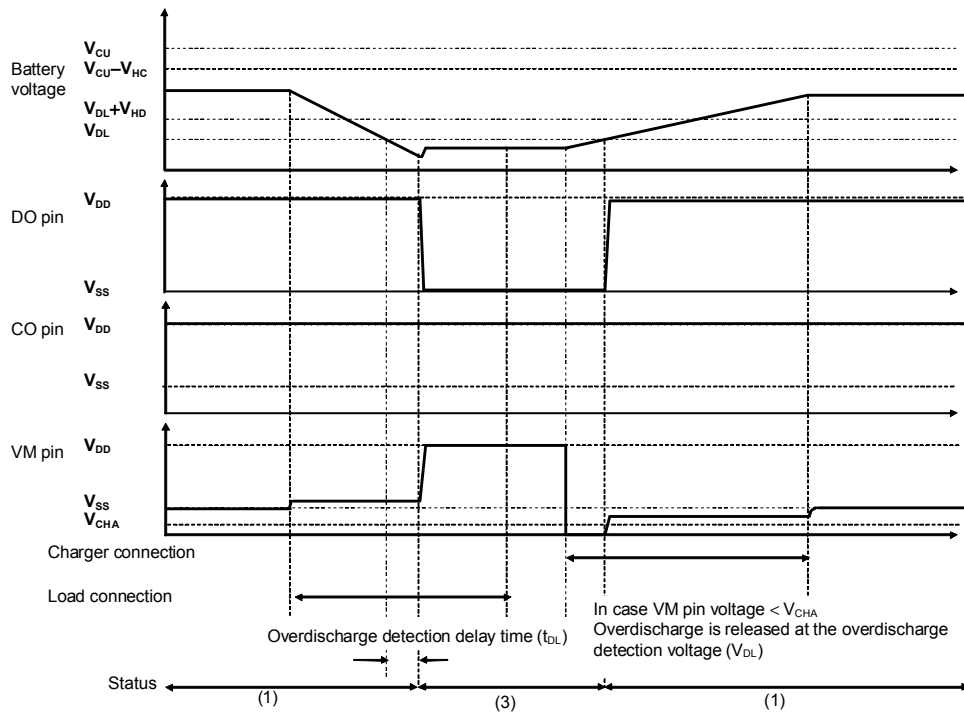

**Remark** (1) Normal status, (2) Overcharge status, (3) Overdischarge status, (4) Overcurrent status  
The charger is supposed to charge with constant current.

Figure 8

(4) Abnormal Charge Current Detection

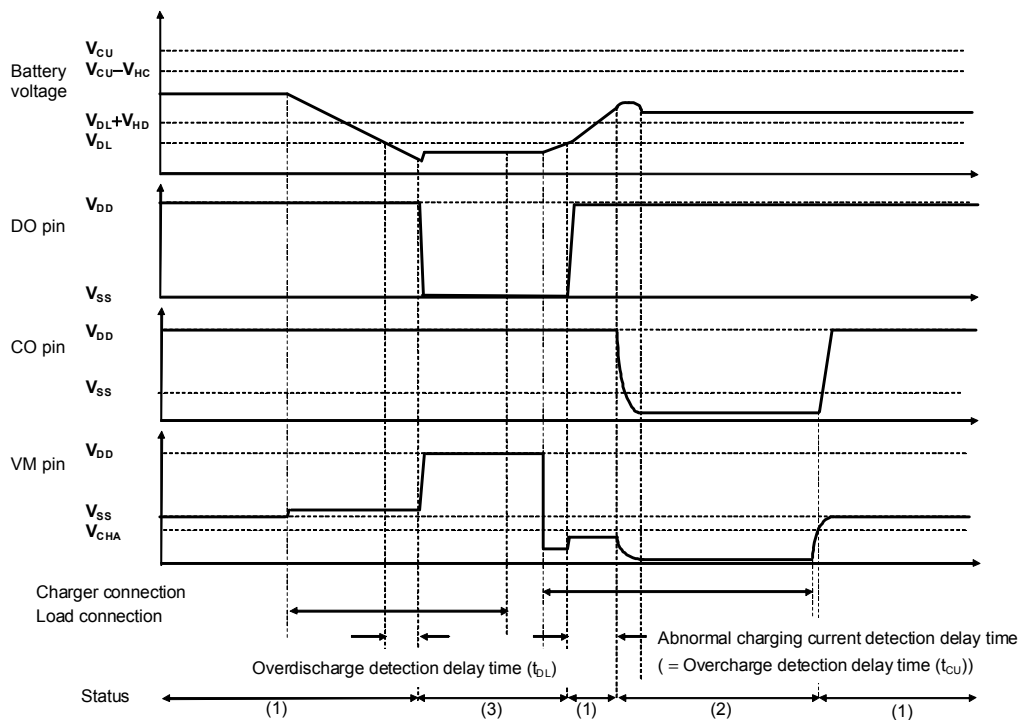

**Remark** (1) Normal status, (2) Overcharge status, (3) Overdischarge status, (4) Overcurrent status  
The charger is supposed to charge with constant current.

Figure 9

■ **Battery Protection IC Connection Example**

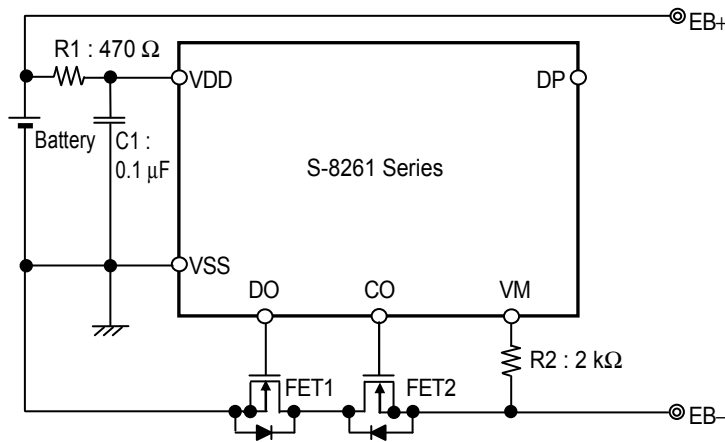

Figure 10

Table 17 Constant for External Components

Symbol	Part	Purpose	Min.	Typ.	Max.	Remarks
FET1	N-channel MOS FET	Discharge control	—	—	—	Threshold voltage $\leq$ Overdischarge detection voltage <sup>*1</sup> Gate to source withstanding voltage $\geq$ Charger voltage <sup>*2</sup>
FET2	N-channel MOS FET	Charge control	—	—	—	Threshold voltage $\leq$ Overdischarge detection voltage <sup>*1</sup> Gate to source withstanding voltage $\geq$ Charger voltage <sup>*2</sup>
R1	Resistor	ESD protection, For power fluctuation	300 $\Omega$	470 $\Omega$	1 k $\Omega$	Resistance should be as small as possible to avoid lowering of the overcharge detection accuracy caused by VDD pin current. <sup>*3</sup>
C1	Capacitor	For power fluctuation	0.022 $\mu$ F	0.1 $\mu$ F	1.0 $\mu$ F	Install a capacitor of 0.022 $\mu$ F or higher between VDD and VSS. <sup>*4</sup>
R2	Resistor	Protection for reverse connection of a charger	300 $\Omega$	2 k $\Omega$	4 k $\Omega$	Select a resistance as large as possible to prevent large current when a charger is connected in reverse. <sup>*5</sup>

- \*1. If the threshold voltage of an FET is low, the FET may not cut the charging current.  
If an FET with a threshold voltage equal to or higher than the overdischarge detection voltage is used, discharging may be stopped before overdischarge is detected.
- \*2. If the withstanding voltage between the gate and source is lower than the charger voltage, the FET may be destroyed.
- \*3. If R1 has a high resistance, the voltage between VDD and VSS may exceed the absolute maximum rating when a charger is connected in reverse since the current flows from the charger to the IC. Insert a resistor of 300  $\Omega$  or higher to R1 for ESD protection.
- \*4. If a capacitor of less than 0.022  $\mu$ F is connected to C1, DO may oscillate when load short-circuiting is detected. Be sure to connect a capacitor of 0.022  $\mu$ F or higher to C1.
- \*5. If R2 has a resistance higher than 4 k $\Omega$ , the charging current may not be cut when a high-voltage charger is connected.

**Caution 1. The above constants may be changed without notice.**

2. The DP pin should be open.
3. It has not been confirmed whether the operation is normal or not in circuits other than the above example of connection. In addition, the example of connection shown above and the constant do not guarantee proper operation. Perform thorough evaluation using the actual application to set the constant.



**■ Precautions**

- The application conditions for the input voltage, output voltage, and load current should not exceed the package power dissipation.
- Do not apply an electrostatic discharge to this IC that exceeds the performance ratings of the built-in electrostatic protection circuit.
- SII Semiconductor Corporation claims no responsibility for any and all disputes arising out of or in connection with any infringement by products including this IC of patents owned by a third party.

■ **Characteristics (Typical Data)**

**1. Detection / Release Voltage Temperature Characteristics**

Overcharge detection voltage vs. temperature

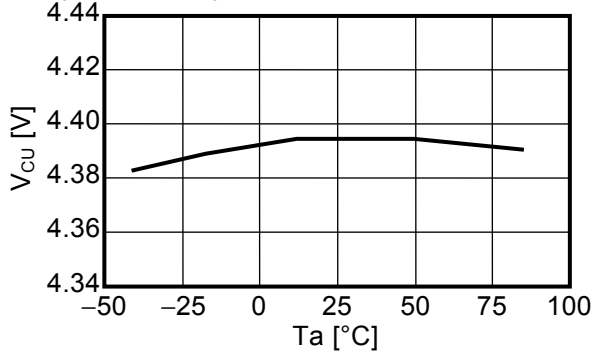

Overcharge release voltage vs. temperature

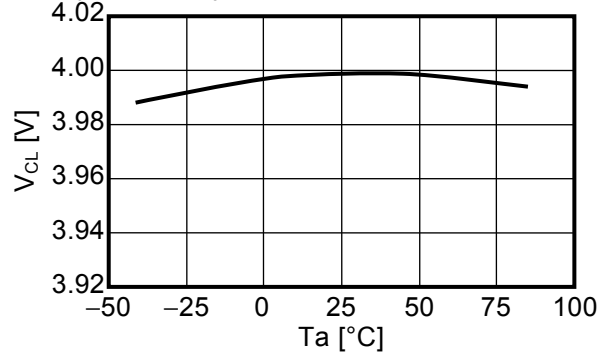

Overdischarge detection voltage vs. temperature

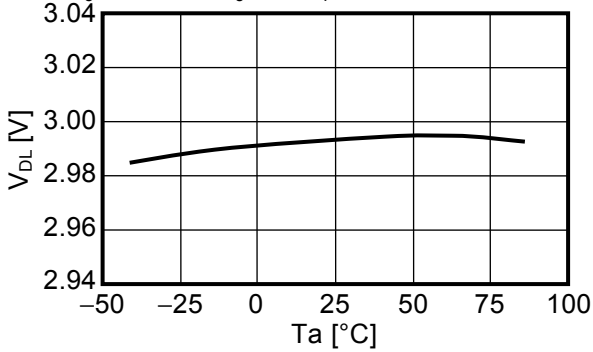

Overdischarge release voltage vs. temperature

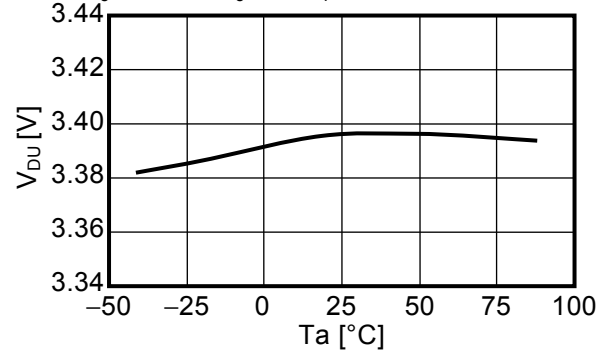

Overcurrent 1 detection voltage vs. temperature

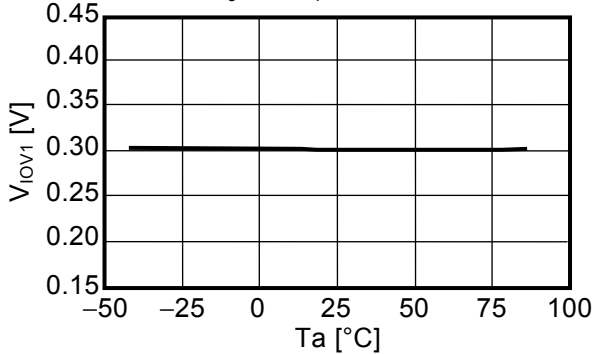

Overcurrent 2 detection voltage vs. temperature

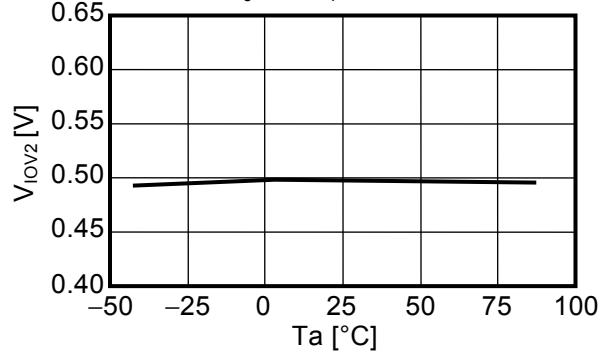

Load short-circuiting detection voltage vs. temperature

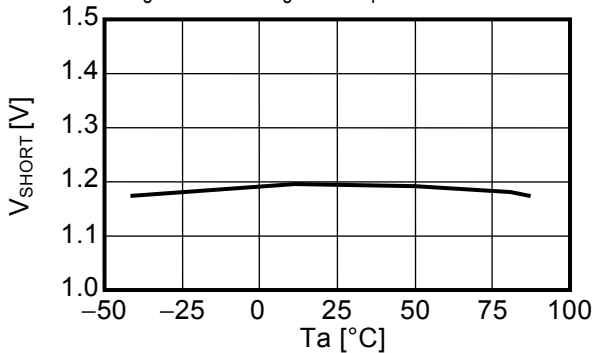

**2. Current Consumption Temperature Characteristics**

Current consumption vs. temperature in normal mode

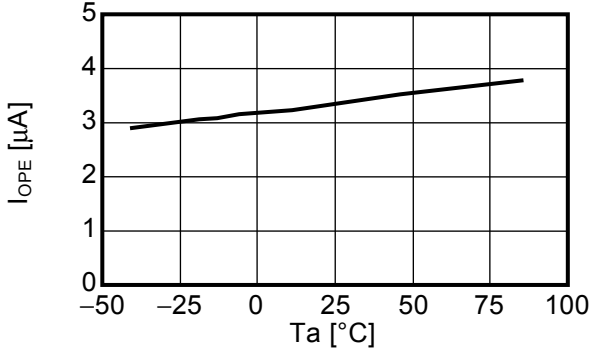

Current consumption vs. temperature in power-down mode

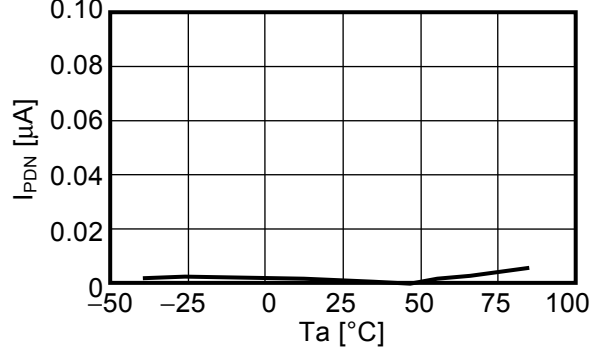

**3. Current Consumption Power Voltage Characteristics (Ta = 25°C)**

Current consumption vs. power supply voltage dependency

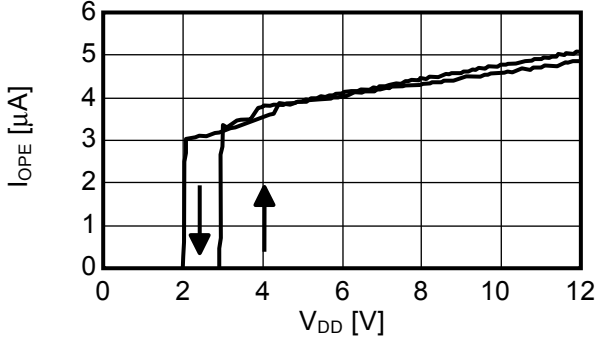

**4. Detection / Release Delay Time Temperature Characteristics**

Overcharge detection delay time vs. temperature

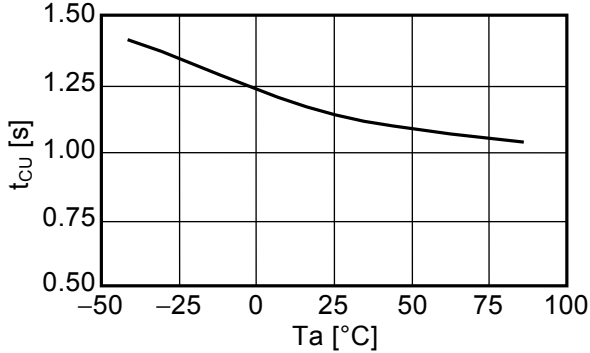

Overcharge release delay time vs. temperature

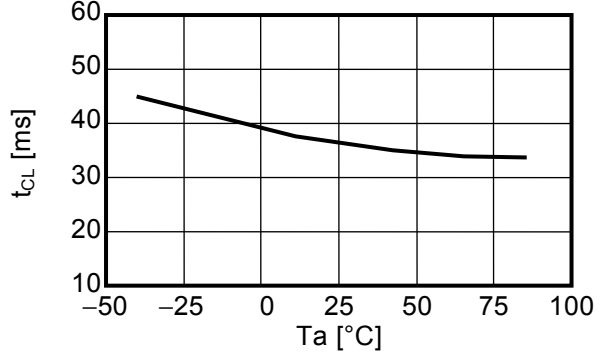

Overdischarge detection delay time vs. temperature

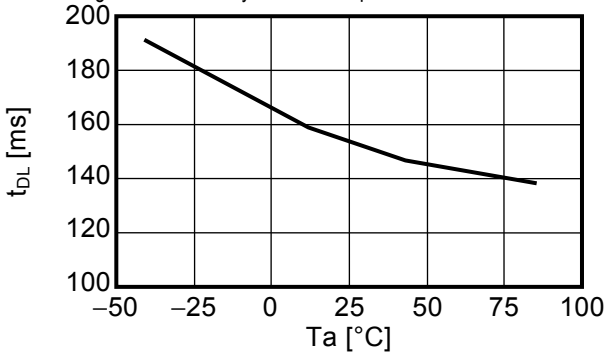

Overcurrent 1 detection delay time vs. temperature

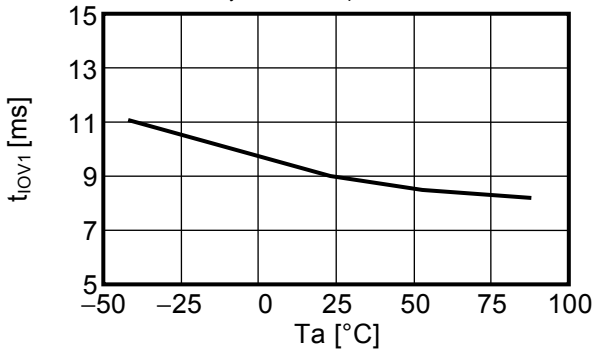

Overcurrent 2 detection delay time vs. temperature

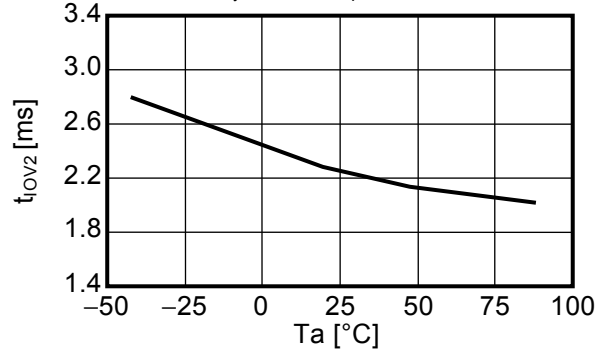

Load short-circuiting detection delay time vs. temperature

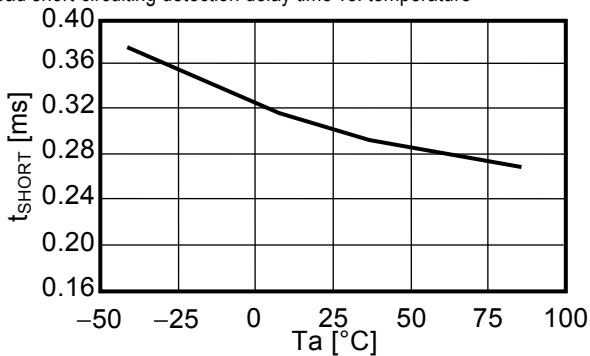

**5. Delay Time Power-Voltage Characteristics (Ta = 25°C)**

Overcurrent 1 detection delay time vs. power supply voltage dependency

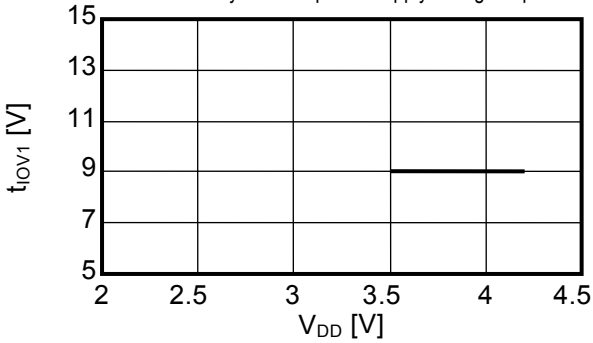

Overcurrent 2 detection delay time vs. power supply voltage dependency

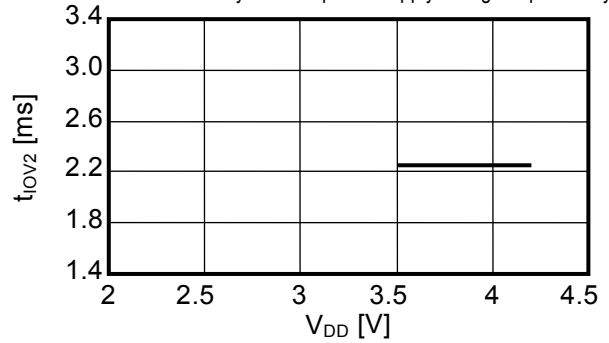

Load short-circuiting detection delay time vs. power supply voltage dependency

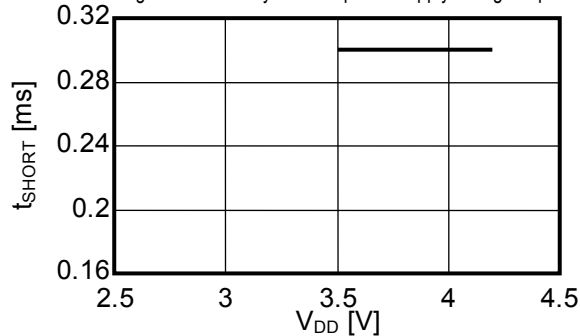

6. CO Pin / DO Pin Output Current Characteristics (Ta = 25°C)

CO pin source current characteristics  $V_{DD} = 3.5\text{ V}, V_M = V_{SS} = 0\text{ V}$

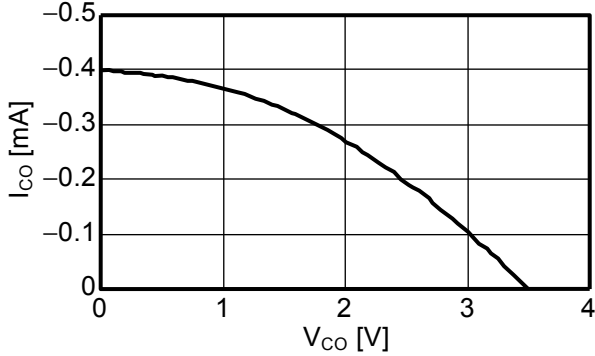

CO pin sink current characteristics  $V_{DD} = 4.5\text{ V}, V_M = V_{SS} = 0\text{ V}$

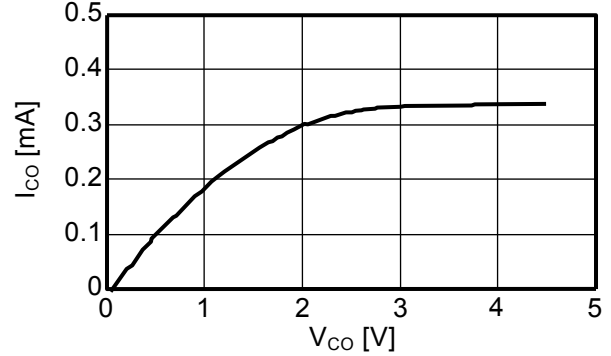

DO pin source current characteristics  $V_{DD} = 3.5\text{ V}, V_M = V_{SS} = 0\text{ V}$

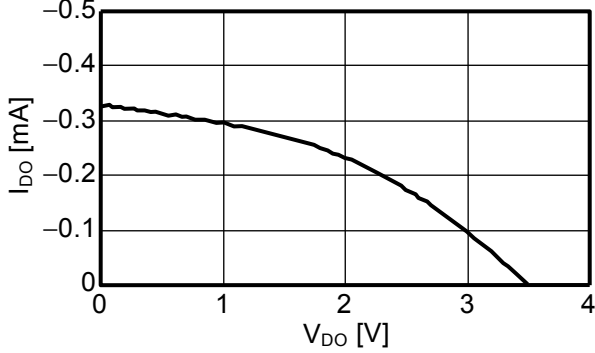

DO pin sink current characteristics  $V_{DD} = 1.8\text{ V}, V_M = V_{SS} = 0\text{ V}$

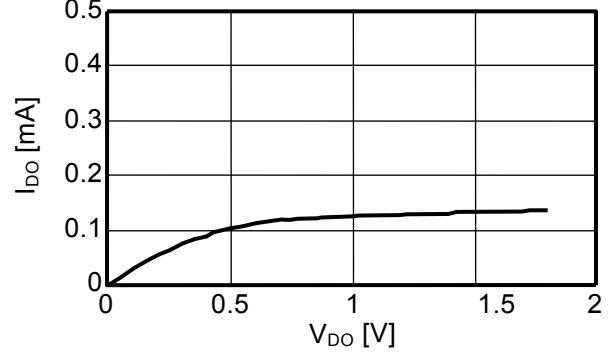



No. MP006-A-P-SD-2.1

TITLE	SOT236-A-PKG Dimensions
No.	MP006-A-P-SD-2.1
ANGLE	
UNIT	mm
SII Semiconductor Corporation	



No. MP006-A-C-SD-3.1

TITLE	SOT236-A-Carrier Tape
No.	MP006-A-C-SD-3.1
ANGLE	
UNIT	mm
SII Semiconductor Corporation	



Enlarged drawing in the central part



No. MP006-A-R-SD-2.1

TITLE	SOT236-A-Reel		
No.	MP006-A-R-SD-2.1		
ANGLE		QTY	3,000
UNIT	mm		
SII Semiconductor Corporation			



## Disclaimers (Handling Precautions)

1. All the information described herein (product data, specifications, figures, tables, programs, algorithms and application circuit examples, etc.) is current as of publishing date of this document and is subject to change without notice.
2. The circuit examples and the usages described herein are for reference only, and do not guarantee the success of any specific mass-production design.  
SII Semiconductor Corporation is not responsible for damages caused by the reasons other than the products or infringement of third-party intellectual property rights and any other rights due to the use of the information described herein.
3. SII Semiconductor Corporation is not responsible for damages caused by the incorrect information described herein.
4. Take care to use the products described herein within their specified ranges. Pay special attention to the absolute maximum ratings, operation voltage range and electrical characteristics, etc.  
SII Semiconductor Corporation is not responsible for damages caused by failures and/or accidents, etc. that occur due to the use of products outside their specified ranges.
5. When using the products described herein, confirm their applications, and the laws and regulations of the region or country where they are used and verify suitability, safety and other factors for the intended use.
6. When exporting the products described herein, comply with the Foreign Exchange and Foreign Trade Act and all other export-related laws, and follow the required procedures.
7. The products described herein must not be used or provided (exported) for the purposes of the development of weapons of mass destruction or military use. SII Semiconductor Corporation is not responsible for any provision (export) to those whose purpose is to develop, manufacture, use or store nuclear, biological or chemical weapons, missiles, or other military use.
8. The products described herein are not designed to be used as part of any device or equipment that may affect the human body, human life, or assets (such as medical equipment, disaster prevention systems, security systems, combustion control systems, infrastructure control systems, vehicle equipment, traffic systems, in-vehicle equipment, aviation equipment, aerospace equipment, and nuclear-related equipment), excluding when specified for in-vehicle use or other uses. Do not use those products without the prior written permission of SII Semiconductor Corporation. Especially, the products described herein cannot be used for life support devices, devices implanted in the human body and devices that directly affect human life, etc.  
Prior consultation with our sales office is required when considering the above uses.  
SII Semiconductor Corporation is not responsible for damages caused by unauthorized or unspecified use of our products.
9. Semiconductor products may fail or malfunction with some probability.  
The user of these products should therefore take responsibility to give thorough consideration to safety design including redundancy, fire spread prevention measures, and malfunction prevention to prevent accidents causing injury or death, fires and social damage, etc. that may ensue from the products' failure or malfunction.  
The entire system must be sufficiently evaluated and applied on customer's own responsibility.
10. The products described herein are not designed to be radiation-proof. The necessary radiation measures should be taken in the product design by the customer depending on the intended use.
11. The products described herein do not affect human health under normal use. However, they contain chemical substances and heavy metals and should therefore not be put in the mouth. The fracture surfaces of wafers and chips may be sharp. Take care when handling these with the bare hands to prevent injuries, etc.
12. When disposing of the products described herein, comply with the laws and ordinances of the country or region where they are used.
13. The information described herein contains copyright information and know-how of SII Semiconductor Corporation.  
The information described herein does not convey any license under any intellectual property rights or any other rights belonging to SII Semiconductor Corporation or a third party. Reproduction or copying of the information described herein for the purpose of disclosing it to a third-party without the express permission of SII Semiconductor Corporation is strictly prohibited.
14. For more details on the information described herein, contact our sales office.

1.0-2016.01

