



## GS4915 ClockCleaner™

### Key Features

- Reduces jitter for clocks of 148.5MHz, 148.5/1.001MHz, 74.25MHz, 74.25/1.001MHz and 27MHz
- Output jitter as low as 20ps peak to peak
- Automatic bypass mode for all other clock rates
- Loop bandwidth adjustable as low as 2kHz
- Output skew control
- Input selectable as differential or single-ended
- Both single-ended and differential outputs
- Uses the GO1555 VCO
- Small 6mm x 6mm 40-pin QFN package
- Pb-free and RoHS compliant

### Applications

High definition video systems. Digital video recording, playback, processing and display devices.

### Description

The GS4915 provides a low jitter clock output when fed with an HD or SD video clock input. Other input clock frequencies between 12MHz and 165MHz can be automatically passed through to the GS4915 outputs.

An internal 2:1 mux allows the user to select between a differential or single-ended (LVCMOS) input clock. Both a single-ended LVCMOS-compatible and an LVDS-compatible differential output are provided.

The GS4915 may operate in either auto or fixed frequency mode. In auto mode, the device will automatically clean the selected input clock if its frequency is found to be one of the supported SD or HD clock rates. In fixed mode, the user selects only one of these frequencies to be cleaned.

In addition, the device allows the user to select between auto or manual bypass operation. In autobypass mode, the GS4915 will automatically bypass its cleaning stage and pass the input clock signal directly to the output whenever the device is unlocked, which includes the case where the input frequency is something other than the five frequencies supported. In manual bypass mode, the input signal passes through directly to the output.

The GS4915 can optionally double the output frequency for 74.25MHz or 74.175MHz HD clocks in order to provide optimal jitter performance of some serializers.

The GS4915 also provides the user with a 2-state skew control. The output clocks produced by the device may be advanced by  $\frac{1}{4}$  of an output CLK period in order to accommodate downstream setup and hold requirements.

The GS4915 is designed to operate with the GO1555 VCO.

The GS4915 Clock Cleaner complements Gennum's GS4911B Clock and Timing Generator for implementing a video genlock solution. Whereas the GS4911B itself cleans low-frequency jitter, the GS4915 is designed to clean primarily the higher frequency jitter of clocks generated by the GS4911B.

# Functional Block Diagram

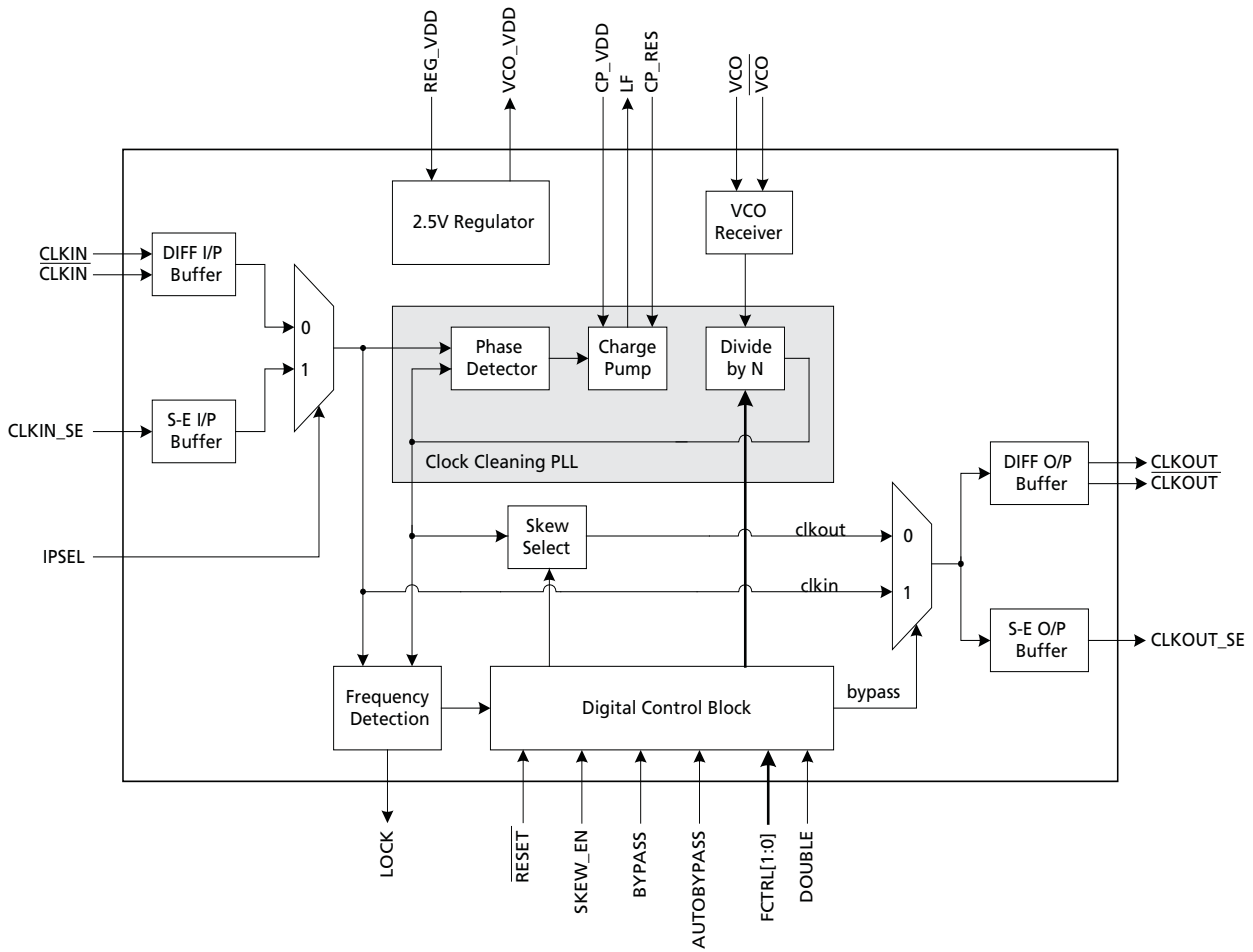

GS4915 Functional Block Diagram

## Revision History

Version	ECR	PCN	Date	Changes and/or Modifications
5	151935	–	June 2009	Updated document with new template.
4	149060	–	February 2008	Updated <a href="#">Figure 4-1: GS4915 Typical Application Circuit</a> .
3	146729	–	November 2007	Converted document to Data Sheet. Updated Power Consumption values in <a href="#">Table 2-1: DC Electrical Characteristics</a> .
2	145306	–	August 2007	Defined IO_VDD see Note 5 in <a href="#">2.2 DC Electrical Characteristics</a> and added chamfer dimensions in <a href="#">6.3 Recommended PCB Footprint</a> . Added pin descriptions for D-VDD, IN_VDD and SEto <a href="#">1.2 Pin Descriptions</a> . Changed Loop Bandwidth to 2kHz in <a href="#">Key Features</a> . Added section <a href="#">3.3.3 Loop Filter</a> and <a href="#">Table 3-1: Loop Filter Component Values</a> . Changed some pin descriptions. Updated power consumption values in <a href="#">Table 2-1: DC Electrical Characteristics</a> .
1	144087	43245	February 2007	Corrected pin 38 (CP_VDD) connection on <a href="#">Typical Application Circuit</a> .
0	142746	–	November 2006	Modified <a href="#">Table 1-1: Pin Descriptions</a> . Updated <a href="#">DC Electrical Characteristics</a> and <a href="#">AC Electrical Characteristics</a> table. Modified <a href="#">Typical Application Circuit</a> . Added junction - board thermal resistance parameter to section <a href="#">6.4 Packaging Data</a> .

# Contents

Key Features .....	1
Applications .....	1
Description .....	1
Functional Block Diagram .....	2
Revision History .....	3
1. Pin Out .....	5
1.1 Pin Assignment .....	5
1.2 Pin Descriptions .....	6
2. Electrical Characteristics .....	9
2.1 Absolute Maximum Ratings .....	9
2.2 DC Electrical Characteristics .....	9
2.3 AC Electrical Characteristics .....	10
3. Detailed Description .....	12
3.1 Functional Overview .....	12
3.2 Clock Inputs .....	12
3.2.1 Differential Clock Input .....	13
3.2.2 Single-Ended Clock Input .....	13
3.2.3 Input Clock Selection .....	13
3.2.4 Unused Clock Inputs .....	13
3.3 Clock Cleaning PLL .....	13
3.3.1 Phase Detector .....	14
3.3.2 Charge Pump .....	14
3.3.3 Loop Filter .....	14
3.3.4 External VCO .....	15
3.4 Modes of Operation .....	15
3.4.1 Frequency Modes .....	15
3.4.2 Bypass Modes .....	17
3.5 Output Clock Frequency and Jitter .....	18
3.6 Output Skew .....	20
3.7 Clock Outputs .....	21
3.7.1 Differential Clock Output .....	21
3.7.2 Single-Ended Clock Output .....	21
3.8 Device Reset .....	21
3.8.1 Hardware Reset .....	21
4. Typical Application Circuit .....	22
5. References & Relevant Standards .....	23
6. Package & Ordering Information .....	24
6.1 Package Dimensions .....	24
6.2 Solder Reflow Profiles .....	25
6.3 Recommended PCB Footprint .....	26
6.4 Packaging Data .....	26
6.5 Ordering Information .....	26

# 1. Pin Out

## 1.1 Pin Assignment

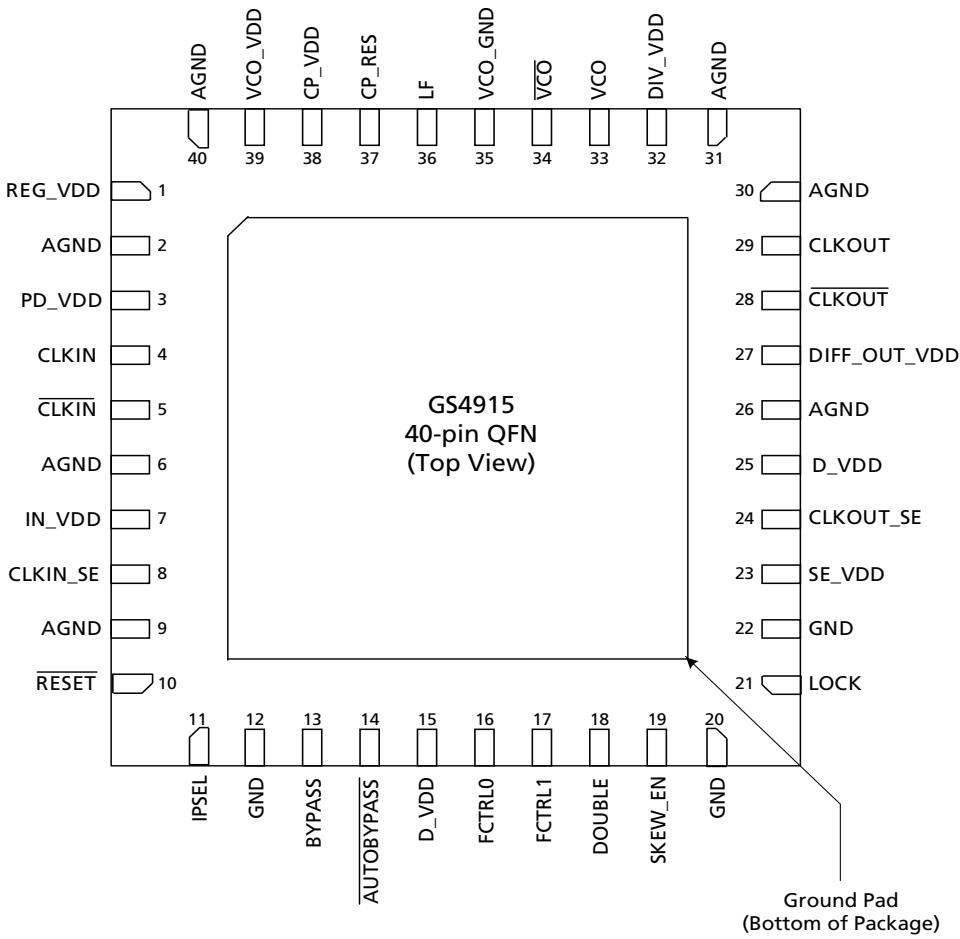

Figure 1-1: 40-Pin QFN

## 1.2 Pin Descriptions

Table 1-1: Pin Descriptions

Pin Number	Name	Timing	Type	Description
1	REG_VDD	–	Power	Positive power supply connection for the internal voltage regulator. Connect to filtered +3.3V DC.
2, 6, 9, 26, 30, 31, 40	AGND	–	Power	Ground connection for analog blocks and IOs. Connect to clean analog GND.
3	PD_VDD	–	Power	Positive power supply connection for the phase detector. Connect to filtered +1.8V DC.
4, 5	CLKIN, $\overline{\text{CLKIN}}$	–	Input	CLOCK SIGNAL INPUTS Signal levels are CML/LVDS compatible. A differential clock input signal is applied to these pins.
7	IN_VDD	–	Power	Positive power supply connection for the single-ended and differential input clock buffers. Supplies CLKIN_SE. Connect to filtered +1.8V DC.
8	CLKIN_SE	–	Input	CLOCK SIGNAL INPUT Signal levels are LVCMOS compatible. A single-ended video clock input signal is applied to this pin.
10	$\overline{\text{RESET}}$	Non synchronous	Input	CONTROL SIGNAL INPUT Signal levels are LVCMOS/LVTTL compatible. See <a href="#">Section 3.8.1</a> for operation.
11	IPSEL	Non synchronous	Input	CONTROL SIGNAL INPUT Signal levels are LVCMOS compatible. Selects which input clock is cleaned by the device. See <a href="#">Section 3.2.3</a> for operation.
12, 20, 22	GND	–	Power	Ground connection for digital blocks and IO's. Connect to GND.
13	BYPASS	Non synchronous	Input	CONTROL SIGNAL INPUT Signal levels are LVCMOS compatible. See Manual Bypass <a href="#">Section 3.4.2</a> .
14	$\overline{\text{AUTOBYPASS}}$	Non synchronous	Input	CONTROL SIGNAL INPUT Signal levels are LVCMOS compatible. Selects the bypass mode of the device. See Manual Bypass <a href="#">Section 3.4.2</a> .
15	D_VDD	–	Power	Positive power supply connection for digital block. Connect to filtered +1.8V DC. The digital block includes pins 10 - 21.
17, 16	FCTRL1, FCTRL0	Non synchronous	Input	CONTROL SIGNAL INPUTS Signal levels are LVCMOS compatible. Selects the frequency mode of the device. See <a href="#">Section 3.4.1</a> for operation.

**Table 1-1: Pin Descriptions (Continued)**

Pin Number	Name	Timing	Type	Description
18	DOUBLE	Non synchronous	Input	CONTROL SIGNAL INPUT Signal levels are LVCMOS compatible. Controls the output frequency of the cleaned clock, for HD input clocks. See <a href="#">Section 3.5</a> for operation.
19	SKEW_EN	Non synchronous	Input	CONTROL SIGNAL INPUT Signal levels are LVCMOS compatible. Selects the phase of the output clock with respect to the selected input clock. See <a href="#">Section 3.6</a> for operation.
21	LOCK	Non synchronous	Output	STATUS SIGNAL OUTPUT Signal levels are LVCMOS compatible. This pin will be HIGH when the output clock is locked to the selected input clock. It will be LOW otherwise.
23	SE_VDD	–	Power	Positive power supply connection for the single-ended clock driver. Determines the output level of CLKOUT_SE. Connect to filtered +1.8V DC or +3.3V DC. NOTE: If the single-ended clock output is not used, this pin should be tied to ground.
24	CLKOUT_SE	–	Output	CLOCK SIGNAL OUTPUT Signal levels are LVCMOS compatible. Single-ended video clock output signal. See <a href="#">Section 3.7.2</a> for operation.
25	D_VDD	–	Power	Positive power supply connection for the single-ended output clock buffer. Connect to filtered +1.8V DC. NOTE: If the single-ended clock output is not used, this pin should be tied to ground.
27	DIFF_OUT_VDD	–	Power	Positive power supply connection for the LVDS clock outputs. Connect to filtered +1.8V DC. NOTE: If the LVDS clock outputs are not used, this pin should be tied to ground.
29, 28	CLKOUT, $\overline{\text{CLKOUT}}$	–	Output	CLOCK SIGNAL OUTPUT Differential video clock output signal. This is the lowest jitter output of the device. See <a href="#">Section 3.7.1</a> for operation.
32	DIV_VDD	–	Power	Positive power supply connection for the divider block. Connect to filtered +1.8V DC.
33,34	VCO, $\overline{\text{VCO}}$	Analog	Input	Differential input for the external VCO reference signal. When using the recommended VCO, leave $\overline{\text{VCO}}$ unconnected. See <a href="#">Section 3.3.4</a> for operation.
35	VCO_GND	–	Power	Ground reference for the external voltage controlled oscillator. Connect to pins 2, 4, 6, and 8 of the GO1555.

**Table 1-1: Pin Descriptions (Continued)**

Pin Number	Name	Timing	Type	Description
36	LF	Analog	Output	Control voltage for the external voltage controlled oscillator. Connect to pin 5 of the GO1555 via a low pass filter. See <a href="#">Typical Application Circuit on page 22</a> .
37	CP_RES	Analog	Input	Charge pump current control. Connect to VCO_GND via a 10kΩ resistor.
38	CP_VDD	–	Power	Power supply for the internal charge pump block (nominally +2.5V DC). Connect to VCO_VDD (pin 39).
39	VCO_VDD	–	Power	Power supply for the external voltage controlled oscillator (+2.5V DC). Connect to pin 7 of the GO1555. This pin is an output. Must be isolated from all other power supplies.
–	Ground Pad	–	Power	Ground pad on bottom of package must be soldered to AGND plane of PCB.



## 2. Electrical Characteristics

### 2.1 Absolute Maximum Ratings

Parameter	Value
Supply Voltage (SE_VDD, REG_VDD)	-0.3 to +4.0 V <sub>DC</sub>
Core Supply Voltage (all 1.8V supplies)	-0.3 to +2.2 V <sub>DC</sub>
Input ESD Voltage	1 kV HBM
Storage Temperature	-50°C < T <sub>S</sub> < 125°C
Operating Temperature	-20°C < T <sub>A</sub> < 85°C

NOTE: Absolute Maximum Ratings are those values beyond which damage to the device may occur. Functional operation under these conditions or at any other condition beyond those indicated in the AC/DC Electrical Characteristic sections is not implied.

### 2.2 DC Electrical Characteristics

**Table 2-1: DC Electrical Characteristics**

V<sub>DD</sub> = 1.8V ±5%, 3.3V ±5%; T<sub>A</sub> = -20°C to 85°C, unless otherwise shown

Parameter	Symbol	Conditions	Min	Typ	Max	Units	Notes
Operating Temperature Range	T <sub>A</sub>	–	-20	25	85	°C	–
Power Consumption (SE_VDD = 1.8V Nominal)	P <sub>1.8V</sub>	1.8V Rail	–	156	270	mW	–
		3.3V Rail	–	58	87	mW	–
Power Consumption (SE_VDD = 3.3V Nominal)	P <sub>3.3V</sub>	1.8V Rail	–	132	243	mW	–
		3.3V Rail	–	133	156	mW	–
+1.8V Power Supply Voltage	–	–	1.71	1.8	1.89	V	–
+3.3V Power Supply Voltage	–	–	3.135	3.3	3.465	V	–
+2.5V Regulator Output Voltage	–	Output load of 3-12mA	2.375	2.5	2.625	V	–
Input Voltage, Logic LOW	V <sub>IL</sub>	–	–	0	0.35 x IO_VDD	V	1,5
Input Voltage, Logic HIGH	V <sub>IH</sub>	–	0.65 x IO_VDD	1.8	–	V	1,5
Output Voltage, Logic LOW	V <sub>OL</sub>	1.8V or 3.3V operation	–	0	0.4	V	2,3,5
Output Voltage, Logic HIGH	V <sub>OH</sub>	1.8V operation	0.65 x IO_VDD	1.8	–	V	2,3,5
		3.3V operation	0.65 x IO_VDD	3.3	–	V	2,3,5

**Table 2-1: DC Electrical Characteristics (Continued)**

$V_{DD} = 1.8V \pm 5\%$ ,  $3.3V \pm 5\%$ ;  $T_A = -20^{\circ}C$  to  $85^{\circ}C$ , unless otherwise shown

Parameter	Symbol	Conditions	Min	Typ	Max	Units	Notes
Clock Output Drive Current	-	1.8V operation	-	10	-	mA	2,3,4
		3.3V operation	-	8	-	mA	2,3,4
Differential Input Common Mode Voltage	$V_{ICM}$	-	1.12	1.25	1.38	V	-
Differential Input Swing	$V_{IDIFF}$	-	240	350	460	mV	-
Differential Clock Output Common Mode Voltage	$V_{OCM}$	100 $\Omega$ termination between CLKOUT and $\overline{CLKOUT}$	-	1.45	-	V	-
Differential Clock Output Swing	$V_{ODIFF}$	100 $\Omega$ termination between CLKOUT and $\overline{CLKOUT}$	250	350	460	mV	6

**NOTES:**

1. For all LVCMOS compatible inputs.
2. For LVCMOS compatible output SE\_CLK.
3. For LVCMOS compatible output LOCK.
4. While still satisfying  $V_{OL}$  max and  $V_{OH}$  min.
5. IO\_VDD refers to the power supply that supplies the particular pin in question. D\_VDD supplies pins 10-21. IN\_VDD supplies CLKIN\_SE. SE\_VDD supplies CLKOUT\_SE.
6. Differential swing as defined here:

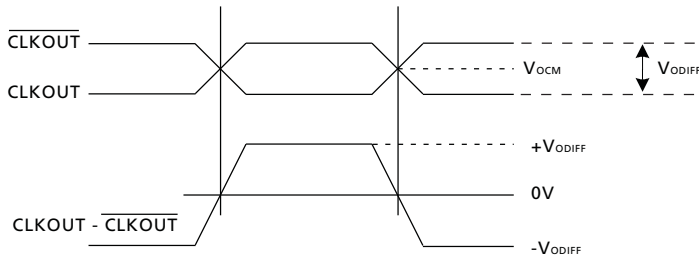

## 2.3 AC Electrical Characteristics

**Table 2-2: AC Electrical Characteristics**

$V_{DD} = 1.8V \pm 5\%$ ,  $T_A = 0^{\circ}C$  to  $70^{\circ}C$ , unless otherwise shown

Parameter	Symbol	Conditions	Min	Typ	Max	Units	Notes
Input Jitter Tolerance	IJT	< 0.5Hz	-10	-	10	UI	1
		0.5Hz to 1Hz	-5	-	5	UI	1
		1Hz to 100Hz	-1	-	1	UI	1
		> 100Hz	-0.1	-	0.1	UI	1

**Table 2-2: AC Electrical Characteristics (Continued)**

V<sub>DD</sub> = 1.8V ±5%, T<sub>A</sub> = 0°C to 70°C, unless otherwise shown

Parameter	Symbol	Conditions	Min	Typ	Max	Units	Notes
Output Jitter Differential Output	–	100kHz to 10MHz	–	20	–	ps	–
	–	Unfiltered	–	40	–	ps	–
Output Jitter Single-ended Output	–	100kHz to 10MHz	–	60	–	ps	–
	–	Unfiltered	–	100	–	ps	–
Output Duty Cycle	–	Differential output	45	–	55	%	–
	–	Single-ended output	40	–	60	%	–
Differential Clock Output Rise / Fall Time	–	100Ω diff. load	–	500	–	ps	–
Single-ended Clock Output Rise / Fall Time	–	10 pF load	–	1200	–	ps	–
Input Clock Frequency	–	–	12	–	165	MHz	–
Output Clock Frequency	–	–	12	–	165	MHz	–
Lock Detect Time	t <sub>LOCKD</sub>	Within 300ppm of reference frequency	–	–	500	us	–
Unlock Detect Time	t <sub>UNLOCKD</sub>	Within 700ppm of reference frequency	–	–	500	us	–
Lock Time	t <sub>LOCK</sub>	–	–	–	1	s	2
Device Latency	–	Differential in, Differential out, SKEW_EN = LOW	–	1.2	–	ns	–
	–	Differential in, Differential out, SKEW_EN = HIGH	–	1.2 - T <sub>out</sub> /4	–	ns	–
	–	Single ended in, single ended out, SKEW_EN = LOW	–	3.5	–	ns	–
	–	Single ended in, single ended out, SKEW_EN = HIGH	–	3.5 - T <sub>out</sub> /4	–	ns	–
Device Latency Difference	–	–	–	750	–	ps	3

**NOTES:**

1. One UI refers to one cycle of the input CLK.
2. Assuming power up has already occurred.
3. Difference between cleaning and bypass modes.

# 3. Detailed Description

## 3.1 Functional Overview

The GS4915 provides a low jitter clock output when fed with an HD or SD video clock input. Other input clock frequencies between 12MHz and 165MHz can be automatically passed through to the GS4915 outputs.

An internal 2:1 mux allows the user to select between a differential (CML/LVDS compatible) or single-ended (LVCMOS) input clock. Both a single-ended LVCMOS-compatible and an LVDS-compatible differential output are provided.

The GS4915 may operate in either auto or fixed frequency mode. In auto mode, the device will automatically clean the selected input clock if its frequency is found to be one of the supported SD or HD clock rates. In fixed mode, the user selects only one of these frequencies to be cleaned.

In addition, the device allows the user to select between auto or manual bypass operation. In autobypass mode, the GS4915 will automatically bypass its cleaning stage and pass the input clock signal directly to the output whenever the device is unlocked which includes the case where the input frequency is something other than the five frequencies supported. In manual bypass mode, the input signal passes through directly to the output.

The GS4915 can optionally double the output frequency for 74.25MHz or 74.175MHz HD clocks in order to provide optimal jitter performance of some serializers.

The GS4915 also provides the user with a 2-state skew control. The output clocks produced by the device may be advanced by  $\frac{1}{4}$  of an output CLK period in order to accommodate downstream setup and hold requirements.

The GS4915 is designed to operate with the GO1555 VCO.

The GS4915 Clock Cleaner complements Gennum's GS4911B Clock and Timing Generator for implementing a video genlock solution. Whereas the GS4911B itself cleans low-frequency jitter, the GS4915 is designed to clean primarily the higher frequency jitter of clocks generated by the GS4911B.

## 3.2 Clock Inputs

The GS4915 contains two separate input buffers to accept either a differential or single-ended input clock. The applied clock(s) can be any video clock needing cleaning, although typically it will be the video clock specifically used for serialization.

The frequency of the applied clock signal(s) must be between 12MHz and 165MHz.

The clock input buffers use a separate power supply of +1.8V DC supplied via the IN\_VDD pin.

### 3.2.1 Differential Clock Input

A differential LVDS clock signal conforming to the TIA/EIA-644-A standard may be AC-coupled to the CLKIN and  $\overline{\text{CLKIN}}$  pins.

If the GS4911B/10B/01B/00B is used, the PCLK3 and  $\overline{\text{PCLK3}}$  outputs from that device may be directly connected to the CLKIN and  $\overline{\text{CLKIN}}$  inputs of the GS4915, respectively.

The CLKIN and  $\overline{\text{CLKIN}}$  input traces should be tightly-coupled with a controlled differential impedance of 100 $\Omega$ . The pair should be terminated with 100 $\Omega$  at the input to the device as no internal termination is provided.

This input clock is selected as the one to be cleaned by the GS4915 when the IPSEL pin is set LOW.

The clock can be DC coupled if the levels are appropriate, but only AC coupling is recommended. These inputs are both LVDS and CML compatible, and AC coupling is only required in cases where the common mode does not line up.

### 3.2.2 Single-Ended Clock Input

A single-ended clock signal at from 1.8V - 3.3V CMOS levels may be DC-coupled to the CLKIN\_SE pin.

If the GS4911B/10B/01B/00B is used, the PCLK1 or PCLK2 output from that device may be directly connected to the CLKIN\_SE input of the GS4915.

### 3.2.3 Input Clock Selection

An internal 2x1 input multiplexer is provided to allow switching between the differential and single-ended clock inputs using one external pin. When IPSEL is set LOW, the differential clock at the CLKIN/ $\overline{\text{CLKIN}}$  pins is selected as the one to be processed by the device. When IPSEL is set HIGH, the single-ended clock at the CLKIN\_SE pin is selected as the one to be processed.

### 3.2.4 Unused Clock Inputs

If the application will only provide a differential clock input, then the CLKIN\_SE input pin should be connected to AGND.

If only a single-ended clock will be provided, then the CLKIN/ $\overline{\text{CLKIN}}$  pins should be left unconnected.

## 3.3 Clock Cleaning PLL

To obtain a low-jitter output clock signal, the GS4915 uses a clock cleaning phase-locked loop. This block will always attempt to lock an external 1.485GHz VCO signal to the selected input clock. Internal dividers, set by the digital control block based on the frequency mode of the device (see [Section 3.4.1](#)), are used to obtain the final output

clock of 27MHz (divide by 55), 74.25MHz/74.175MHz (divide by 20), or 148.5MHz/148.35MHz (divide by 10).

### 3.3.1 Phase Detector

The GS4915's phase detector can identify phase misalignment between the selected input clock and the reference clock provided by the external VCO, and correspondingly signal the charge pump to alter the VCO control voltage.

### 3.3.2 Charge Pump

The charge pump block of the PLL is powered externally by +2.5V DC applied to CP\_VDD. This is provided by the GS4915 itself at the VCO\_VDD pin. An external RC filter at the CP\_VDD pin is recommended to reduce supply noise for best jitter performance. Please refer to the [Typical Application Circuit on page 22](#).

An external resistance connected to the CP\_RES pin is used to set the charge pump reference current of the device. Typically, the CP\_RES pin will be connected through 10k $\Omega$  to VCO\_GND.

### 3.3.3 Loop Filter

The GS4915 PLL loop filter is an external first order filter formed by a series RC connection as shown in [Table 3-1: Loop Filter Component Values](#). The loop filter resistor value sets the bandwidth of the PLL and the capacitor value controls its stability and lock time. A loop filter resistor value between 1  $\Omega$  and 20  $\Omega$  and a loop filter capacitor value between 1 $\mu$ F and 33 $\mu$ F are recommended.

The GS4915 uses a non-linear, bang-bang, PLL, therefore its bandwidth scales linearly with the input jitter amplitude - greater input jitter results in a smaller loop bandwidth causing more of the input jitter to be rejected. For a given input jitter amplitude, a smaller loop filter resistor produces a narrower loop bandwidth. With an input jitter amplitude of 300ps, for example, the PLL bandwidth can be adjusted from 2KHz to 40KHz by varying the loop filter resistor, as shown in the table below. For use with GS4911, a narrow loop bandwidth is recommended.

Increasing the loop filter capacitor value increases the stability of the PLL, but results in a longer lock time. For loop filter resistors smaller than 7 $\Omega$ , a capacitor value of 33 $\mu$ F is recommended, while larger resistor values can accommodate smaller capacitors. Sample combinations of the loop filter resistor and capacitor values are shown in the table below, along with the resulting loop bandwidth. Additional loop bandwidths can be achieved by using different loop filter resistor values.

**Table 3-1: Loop Filter Component Values**

Loop Filter R	Typical Loop Bandwidth*	Recommended Loop Filter C	Comments
1Ω	2kHz	33μF	Narrow bandwidth - provides maximum jitter reduction. Long lock-time.
7Ω	8kHz	10μF	
20Ω	40kHz	1μF	Wide bandwidth. Fast lock-time.

Note:  
1. \*Measured with 300ps pk-pk input jitter on CLK.

### 3.3.4 External VCO

The GS4915 uses the external GO1555 Voltage Controlled Oscillator as part of its phase-locked loop. This external VCO implementation was chosen to ensure superior jitter performance of the device.

Power for the external VCO is generated entirely by the GS4915 from an on-chip voltage regulator. The internal regulator uses +3.3V DC supplied at the REG\_VDD pin to provide +2.5V at the VCO\_VDD pin.

Based on the control voltage output by the GS4915 on the LF pin, the GO1555 produces a 1.485GHz reference signal for the PLL. This signal must be run via a 50Ω controlled-impedance trace to the VCO pin of the GS4915. The VCO receiver block of the device will then convert this single-ended signal into the differential 1.485GHz reference signal used by the clock cleaning PLL.

Both the reference and controls signals should be referenced to the supplied VCO\_GND, as shown in the recommended application circuit of the [Typical Application Circuit on page 22](#).

## 3.4 Modes of Operation

The GS4915 may operate in one of two possible frequency modes, and in one of three possible bypass modes. The combination of the frequency mode and bypass mode will determine the frequency and jitter of the output clock.

### 3.4.1 Frequency Modes

The frequency mode of the device is determined entirely by the setting of the external FCTRL[1:0] pins.

**Table 3-2: GS4915 Frequency Modes**

FCTRL[1:0]	Frequency Mode
00	Auto
01	Fixed – 27MHz ± 0.4%

**Table 3-2: GS4915 Frequency Modes**

FCTRL[1:0]	Frequency Mode
10	Fixed – 74.25MHz ± 0.4%
11	Fixed – 148.5MHz ± 0.4%

In both Auto and Fixed Frequency modes, the GS4915 will measure the selected input clock frequency to determine if it is in any of the following ranges: 27MHz ± 0.4%, 74.25MHz ± 0.4%, or 148.5MHz ± 0.4% (these ranges include the 74.25MHz/1.001 and 148.5MHz/1.001 video clock frequencies).

### Auto Frequency Mode

When FCTRL[1:0] = 00, the device will operate in Auto Frequency mode. In this mode, the GS4915 will automatically clean the selected input clock if its frequency is found to be contained in any of the ranges listed above.

The LOCK output pin will be HIGH whenever the device has successfully locked its cleaning PLL to the selected input clock. In Auto Frequency mode, LOCK will be HIGH if the input clock frequency is 27MHz ± 0.4%, 74.25MHz ± 0.4%, or 148.5MHz ± 0.4%.

If the input clock varies by more than ± 6.4%, the LOCK output pin will be LOW. Between 0.4% and 6.4%, the device may lock or bypass, as shown in Figure 3-1. Frequencies in this range should not be applied to the device.

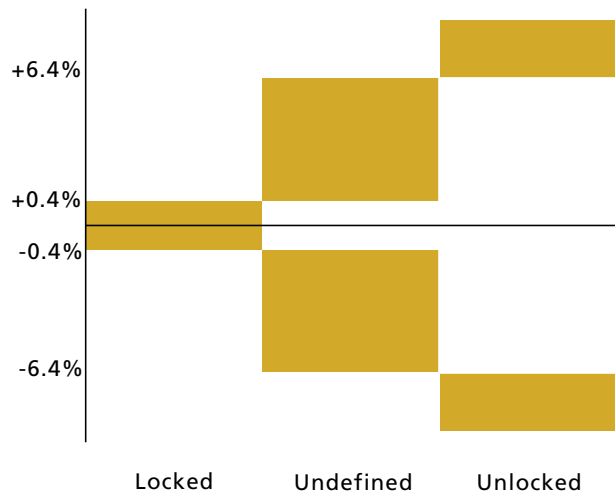

Figure 3-1: Locked, Undefined and Unlocked regions

### Fixed Frequency Mode

When FCTRL[1:0] ≠ 00, the device will operate in Fixed Frequency mode. In this mode, the device will only clean the selected input clock if its frequency is found to be in the range defined by the particular setting of the FCTRL[1:0] pins.



For example, if FCTRL[1:0] = 01, the GS4915 will only clean the input clock if its frequency is 27MHz ± 0.4%; if FCTRL[1:0] = 10, the GS4915 will only clean the input clock if its frequency is 74.25MHz ± 0.4%; and if FCTRL[1:0] = 11, the GS4915 will only clean the input clock if its frequency is 148.5MHz ± 0.4%.

In Fixed Frequency mode, the LOCK output pin will be set HIGH after the device has locked its cleaning PLL to the selected input clock, and only if the input clock frequency matches the frequency selected by the setting of the FCTRL[1:0] pins. Otherwise, LOCK will be LOW.

### 3.4.2 Bypass Modes

The bypass mode of the device is determined by the setting of the external AUTOBYPASS and BYPASS pins.

**Table 3-3: GS4915 Bypass Modes**

AUTOBYPASS	BYPASS	Bypass Mode
0	X	Autobypass Mode
1	0	Forced Output Mode
1	1	Manual Bypass Mode

NOTE: 'X' indicates a "don't care" condition.

#### Autobypass Mode

When AUTOBYPASS is LOW, the device will operate in Autobypass mode. In this mode, the GS4915 will bypass its cleaning stage and pass the selected input clock signal directly to the output whenever LOCK is LOW.

#### Manual Bypass Mode

When AUTOBYPASS and BYPASS are both HIGH, the GS4915 will operate in Manual Bypass Mode. In this mode, the GS4915 will bypass its cleaning stage and pass the selected input clock signal directly to the output.

NOTE: If operating in Manual Bypass mode, the LOCK output pin should be ignored. Depending on the set frequency mode of the device and the detected frequency of the selected input clock, the cleaning PLL of the device may achieve lock and so may set the LOCK pin HIGH; however, the output clock will always be a copy of the input clock, and NOT the cleaned clock.

#### Forced Output Mode

If AUTOBYPASS is HIGH and BYPASS is set LOW, the device will operate in Forced Output mode. In this mode, the cleaning stage of the device is never bypassed, and so the output clock will always be the clock output by the device's PLL, even in an unlocked condition.

When LOCK is HIGH, the output clock will be low-jitter and locked to the selected input clock. But when LOCK is LOW in Forced Output mode, the output clock should not be used.

### 3.5 Output Clock Frequency and Jitter

The frequency and jitter of the output clock are determined by:

- the frequency of the input clock,
- the differential or single-ended input and output clocks,
- the selected frequency mode,
- the selected bypass mode, and
- the setting of the DOUBLE pin.

When the DOUBLE pin is set HIGH, the output clock frequency will be double the input only when the selected input clock frequency is determined to be 74.25MHz ± 0.4%. Otherwise, the setting of the DOUBLE pin will have no effect on the frequency of the output clock.

The output clock will be low jitter when the LOCK pin is HIGH. The only exception to this is if operating in Manual Bypass mode, see Section 3.4.2. Table 3-4, Table 3-5, and Table 3-6 summarize the output frequency and LOCK behaviour of the device given the frequency of the input clock, the selected frequency mode, and the setting of the DOUBLE pin for Autobypass, Manual Bypass, and Forced Output modes, respectively. In each table, 'X' indicates a "don't care" condition.

**Table 3-4: Output Behaviour in Autobypass Mode**

FCTRL[1:0]	Input	DOUBLE	LOCK	Output
Auto [00]	27MHz	X	HIGH	27MHz
	74.25MHz	0	HIGH	74.25MHz
		1	HIGH	148.5MHz
	148.5MHz	X	HIGH	148.5MHz
	Other	X	LOW	Input
Fixed – 27MHz [01]	27MHz	X	HIGH	27MHz
	74.25MHz	X	LOW	74.25MHz
	148.5MHz	X	LOW	148.5MHz
	Other	X	LOW	Input

**Table 3-4: Output Behaviour in Autobypass Mode**

FCTRL[1:0]	Input	DOUBLE	LOCK	Output
Fixed – 74.25MHz [10]	27MHz	X	LOW	27MHz
	74.25MHz	0	HIGH	74.25MHz
		1	HIGH	148.5MHz
	148.5MHz	X	LOW	148.5MHz
	Other	X	LOW	Input
Fixed – 148.5MHz [11]	27MHz	X	LOW	27MHz
	74.25MHz	X	LOW	74.25MHz
	148.5MHz	X	HIGH	148.5MHz
	Other	X	LOW	Input

**Table 3-5: Output Behaviour in Manual Bypass Mode**

FCTRL[1:0]	Input	DOUBLE	LOCK	Output
Auto [00]	27MHz	X	HIGH*	27MHz
	74.25MHz	X	HIGH*	74.25MHz
	148.5MHz	X	HIGH*	148.5MHz
	Other	X	LOW	Input
Fixed – 27MHz [01]	27MHz	X	HIGH*	27MHz
	74.25MHz	X	LOW	74.25MHz
	148.5MHz	X	LOW	148.5MHz
	Other	X	LOW	Input
Fixed – 74.25MHz [10]	27MHz	0	LOW	27MHz
	74.25MHz	0	HIGH*	74.25MHz
	148.5MHz	0	LOW	148.5MHz
	Other	0	LOW	Input
Fixed – 148.5MHz [11]	27MHz	X	LOW	27MHz
	74.25MHz	X	LOW	74.25MHz
	148.5MHz	X	HIGH*	148.5MHz
	Other	X	LOW	Input

\*NOTE: Although LOCK = HIGH under these conditions, the output clock will be a copy of the selected input clock and will have the jitter of the input clock.

**Table 3-6: Output Behaviour in Forced Output Mode**

FCTRL[1:0]	Input	DOUBLE	LOCK	Output	
Auto [00]	27MHz	X	HIGH	27MHz	
	74.25MHz	0	HIGH	74.25MHz	
		1	HIGH	148.5MHz	
	148.5MHz	X	HIGH	148.5MHz	
	Other	X	LOW	Last locked*	
Fixed – 27MHz [01]	27MHz	X	HIGH	27MHz	
	74.25MHz	X	LOW	27MHz	
	148.5MHz	X	LOW	27MHz	
	Other	X	LOW	27MHz	
Fixed – 74.25MHz [10]	27MHz	0	LOW	74.25MHz	
		1	LOW	148.5MHz	
	74.25MHz	0	HIGH	74.25MHz	
		1	HIGH	148.5MHz	
	148.5MHz	0	LOW	74.25MHz	
		1	LOW	148.5MHz	
	Other	0	LOW	74.25MHz	
		1	LOW	148.5MHz	
	Fixed – 148.5MHz [11]	27MHz	X	LOW	148.5MHz
		74.25MHz	X	LOW	148.5MHz
148.5MHz		X	HIGH	148.5MHz	
Other		X	LOW	148.5MHz	

\*NOTE: The output clock will remain within  $\pm 5\%$  of the last locked frequency if an input frequency other than 27MHz, 74.25MHz, or 148.5MHz is applied to the selected clock input. If operating under these conditions upon power-up, the output frequency will be 74.25MHz  $\pm 5\%$ .

### 3.6 Output Skew

The GS4915 provides the user with the option of advancing the phase of the output clock from that of the input clock. This feature is controlled by the external SKEW\_EN pin.

When SKEW\_EN is set LOW, the output clock will be delayed from the selected input clock only by the latency of the device. By setting SKEW\_EN = HIGH, the user can advance the output clock from the selected input clock by one quarter of an output period, minus the latency of the device. Please see [Figure 3-2](#).

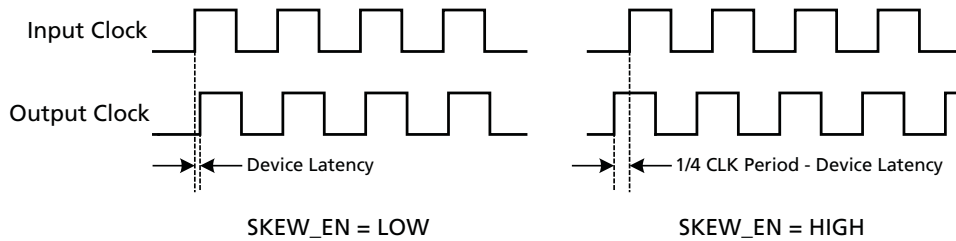

Figure 3-2: Output skew behaviour of GS4915

## 3.7 Clock Outputs

The GS4915 presents both differential and single-ended clock outputs. When the LOCK output signal is HIGH, these clock outputs will be low-jitter and locked to the selected input clock.

NOTE: If in Manual Bypass mode, the LOCK pin may be HIGH although the output clock will always be a copy of the input clock, and NOT the cleaned clock.

The frequency of the differential and single-ended clock outputs will be identical and will be determined as described in [Section 3.5](#).

### 3.7.1 Differential Clock Output

A CML-based driver is used to provide the differential clock output at the CLKOUT and  $\overline{\text{CLKOUT}}$  pins. Although this driver will output a signal amplitude that is compatible to the TIA/EIA-644 LVDS standard, it has an incompatible common mode level. Therefore, AC-coupling and external biasing resistors are required if interfacing the differential clock outputs from the GS4915 to a true LVDS receiver. The common mode is, however, compatible with the LVDS inputs on most FPGAs and can be DC coupled.

This is the lowest-jitter output of the GS4915.

The differential clock output driver uses a separate power supply of +1.8V DC supplied via the DIFF\_OUT\_VDD pin.

### 3.7.2 Single-Ended Clock Output

The single-ended output clock is present at the CLKOUT\_SE pin. The signal will operate at either 1.8V or 3.3V CMOS levels, as determined by the voltage applied to the SE\_VDD pin.

The single-ended clock output pre-drive uses a separate power supply of +1.8V DC supplied via the D\_VDD pin.

## 3.8 Device Reset

### 3.8.1 Hardware Reset

In order to reset the GS4915 to their defaults conditions, the RESET pin must be held LOW for a minimum of  $t_{\text{reset}} = 0.5\text{ms}$ .

# 4. Typical Application Circuit

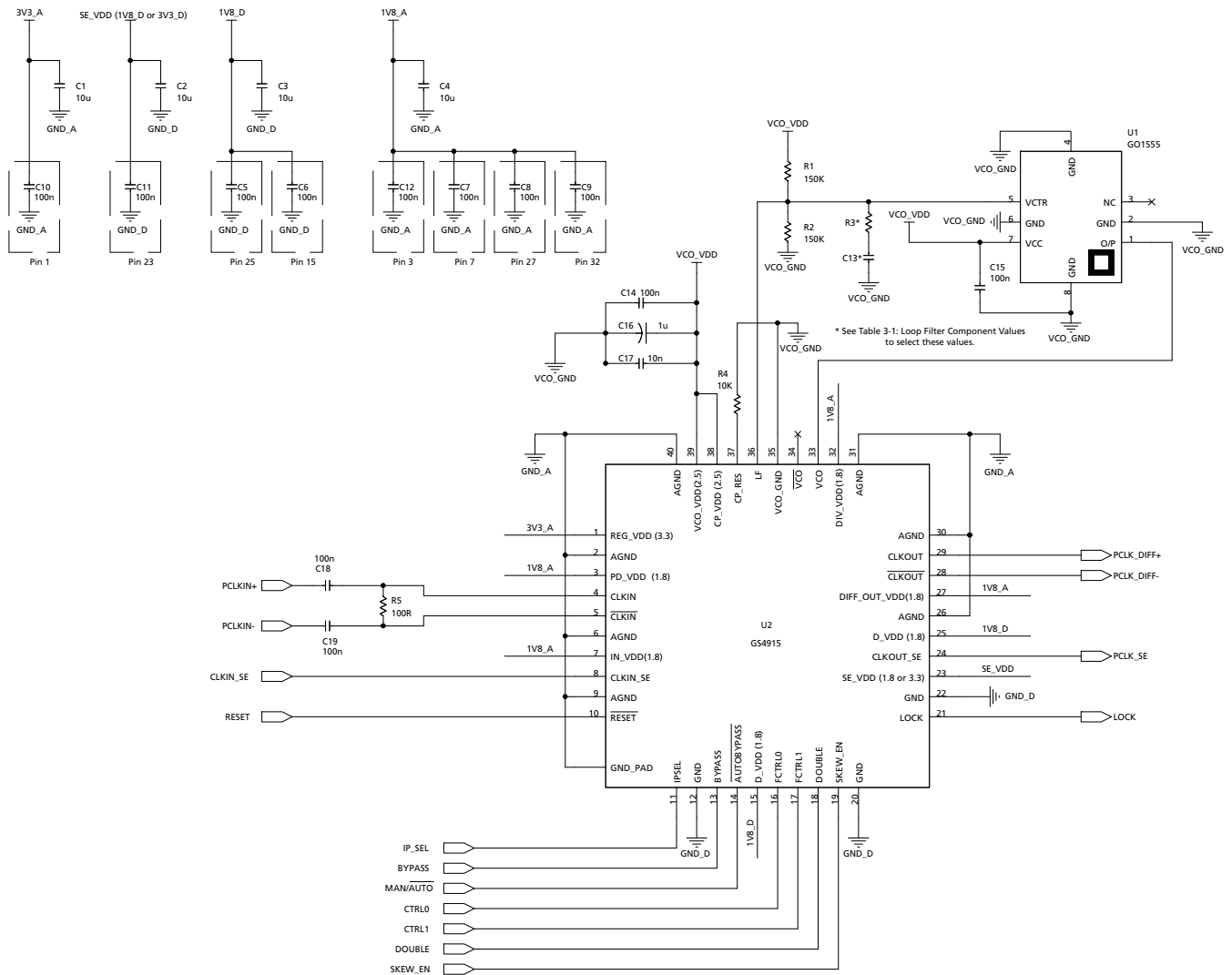

Figure 4-1: GS4915 Typical Application Circuit

# 5. References & Relevant Standards

**Table 5-1: References & Relevant Standards**

EIA/JEDEC JESD8-B	Interface standard for 3V/3.3V Supply Digital Integrated Circuits
EIA/JEDEC JESD8-7	Interface standard for 1.8-V Supply Digital Integrated Circuits
TIA/EIA-644-A	Electrical Characteristics of Low Voltage Differential Signalling (LVDS) Interface Circuits
SMPTE 240M-1999	1125-Line High Definition Production Systems - Signal Parameters
SMPTE 259M-1997	10-bit 4:2:2 Component and 4fsc Composite Digital Signals - Serial Digital Interface
SMPTE 274M-1998	1920 x 1080 Scanning and Analog and Parallel Digital Interfaces for Multiple Picture Rates
SMPTE 292M-1998	Bit-Serial Digital Interface for High-Definition Television Systems
SMPTE 294M-1997	720 x 483 Active Line at 59.94-Hz Progressive Scan Production - Bit-Serial Interfaces
SMPTE 295M-1997	1920 x 1080 50 Hz - Scanning and Interfaces
SMPTE 296M-1997	1280 x 720 Scanning, Analog and Digital Representation and Analog Interface
SMPTE RP 184-2004	Specification of Jitter in Bit-Serial Digital Systems
SMPTE RP 211-2000	Implementation of 24P, 25P and 30P Segmented Frames for 1920 x 1080 Production Format
ITU-R BT.656	Interface for Digital Component Video Signals in 525-Line and 625-Line Television Systems
ITU-R BT.709-4	Parameter Values for the HDTV Standards for Production and International Program Exchange

# 6. Package & Ordering Information

## 6.1 Package Dimensions

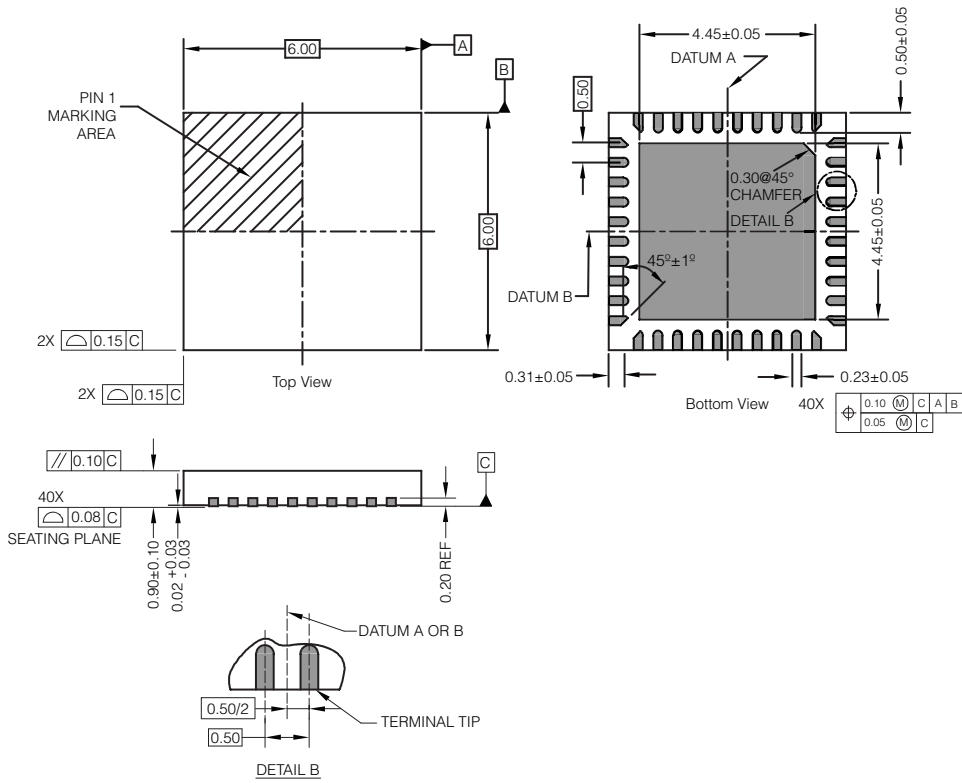



## 6.2 Solder Reflow Profiles

The device is manufactured with Matte-Sn terminations and is compatible with both standard eutectic and Pb-free solder reflow profiles. The recommended standard eutectic reflow profile is shown in Figure 6-1. MSL qualification was performed using the maximum Pb-free reflow profile shown in Figure 6-2.

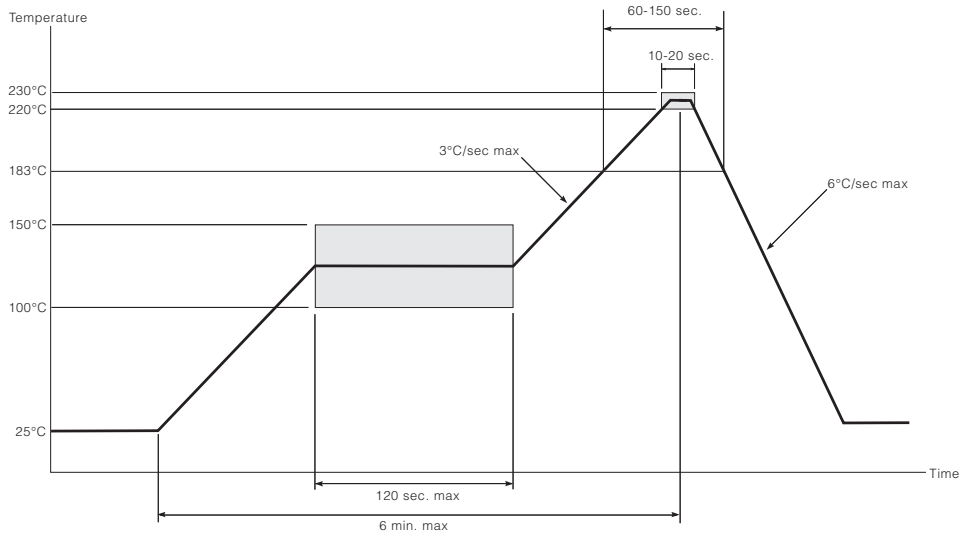

Figure 6-1: Standard Eutectic Solder Reflow Profile

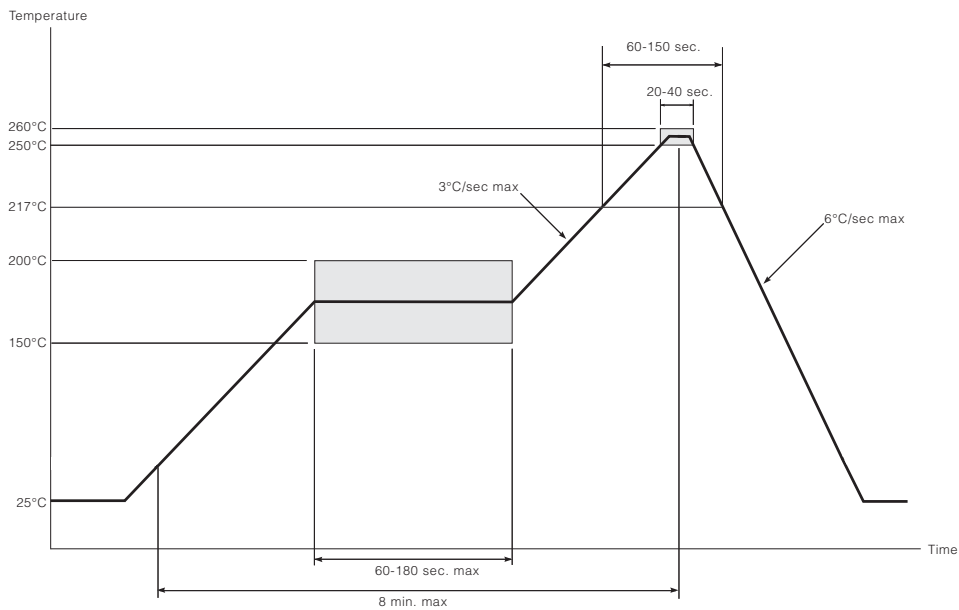
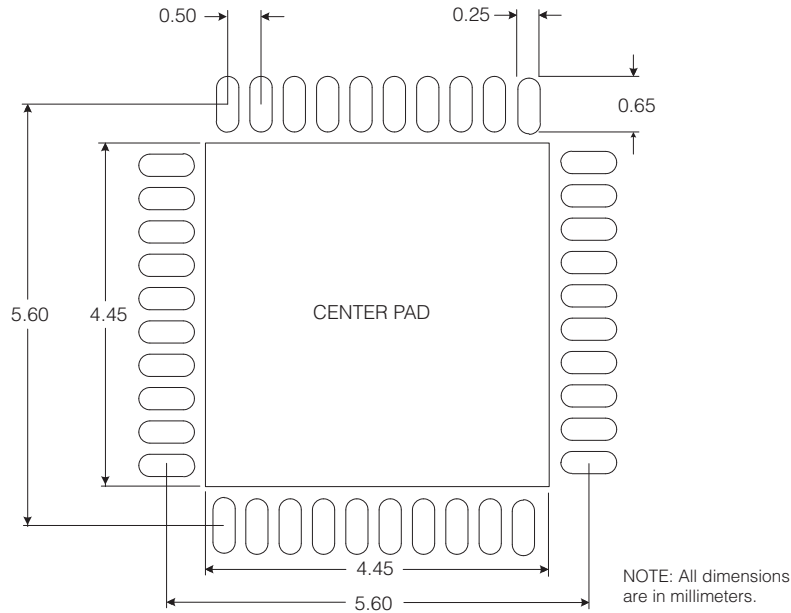

Figure 6-2: Maximum Pb-Free Solder Reflow Profile (Preferred)

## 6.3 Recommended PCB Footprint



NOTE: Suggested dimensions only. Final dimensions should conform to customer design rules 1 and process optimizations.

## 6.4 Packaging Data

Parameter	Value
Package Type	6mm x 6mm 40-pin QFN
Moisture Sensitivity Level	3
Junction to Case Thermal Resistance, $\theta_{j-c}$	19.9°C/W
Junction to Air Thermal Resistance, $\theta_{j-a}$ (at zero airflow)	34.9°C/W
Junction to Board Thermal Resistance, $\theta_{j-b}$	12.5°C/W
Psi, $\psi$	0.5°C/W
Pb-free and RoHS Compliant	Yes

## 6.5 Ordering Information

Part Number	Package	Temperature Range
GS4915-INE3	Pb-free 40-pin QFN	-20°C to 85°C

---

**DOCUMENT IDENTIFICATION  
DATA SHEET**

The product is in production. Gennum reserves the right to make changes to the product at any time without notice to improve reliability, function or design, in order to provide the best product possible.

**CAUTION**

ELECTROSTATIC SENSITIVE DEVICES

DO NOT OPEN PACKAGES OR HANDLE EXCEPT AT A  
STATIC-FREE WORKSTATION

---

**GENNUM CORPORATE HEADQUARTERS**

4281 Harvester Road, Burlington, Ontario L7L 5M4 Canada

Phone: +1 (905) 632-2996

E-mail: [corporate@gennum.com](mailto:corporate@gennum.com)

Fax: +1 (905) 632-2055

[www.gennum.com](http://www.gennum.com)

---

**OTTAWA**232 Herzberg Road, Suite 101  
Kanata, Ontario K2K 2A1  
Canada

Phone: +1 (613) 270-0458

Fax: +1 (613) 270-0429

**CALGARY**3553 - 31st St. N.W., Suite 210  
Calgary, Alberta T2L 2K7  
Canada

Phone: +1 (403) 284-2672

**UNITED KINGDOM**North Building, Walden Court  
Parsonage Lane,  
Bishop's Stortford Hertfordshire, CM23 5DB  
United Kingdom

Phone: +44 1279 714170

Fax: +44 1279 714171

**INDIA**#208(A), Nirmala Plaza,  
Airport Road, Forest Park Square  
Bhubaneswar 751009  
India

Phone: +91 (674) 653-4815

Fax: +91 (674) 259-5733

**SNOWBUSH IP - A DIVISION OF GENNUM**439 University Ave. Suite 1700  
Toronto, Ontario M5G 1Y8  
Canada

Phone: +1 (416) 925-5643

Fax: +1 (416) 925-0581

E-mail: [sales@snowbush.com](mailto:sales@snowbush.com)Web Site: <http://www.snowbush.com>**MEXICO**288-A Paseo de Maravillas  
Jesus Ma., Aguascalientes  
Mexico 20900

Phone: +1 (416) 848-0328

**JAPAN KK**Shinjuku Green Tower Building 27F  
6-14-1, Nishi Shinjuku  
Shinjuku-ku, Tokyo, 160-0023  
Japan

Phone: +81 (03) 3349-5501

Fax: +81 (03) 3349-5505

E-mail: [gennum-japan@gennum.com](mailto:gennum-japan@gennum.com)Web Site: <http://www.gennum.co.jp>**TAIWAN**6F-4, No.51, Sec.2, Keelung Rd.  
Sinyi District, Taipei City 11502  
Taiwan R.O.C.

Phone: (886) 2-8732-8879

Fax: (886) 2-8732-8870

E-mail: [gennum-taiwan@gennum.com](mailto:gennum-taiwan@gennum.com)**GERMANY**Hainbuchenstraße 2  
80935 Muenchen (Munich), Germany

Phone: +49-89-35831696

Fax: +49-89-35804653

E-mail: [gennum-germany@gennum.com](mailto:gennum-germany@gennum.com)**NORTH AMERICA WESTERN REGION**Bayshore Plaza  
2107 N 1st Street, Suite #300  
San Jose, CA 95131  
United States

Phone: +1 (408) 392-9454

Fax: +1 (408) 392-9427

E-mail: [naw\\_sales@gennum.com](mailto:naw_sales@gennum.com)**NORTH AMERICA EASTERN REGION**4281 Harvester Road  
Burlington, Ontario L7L 5M4  
Canada

Phone: +1 (905) 632-2996

Fax: +1 (905) 632-2055

E-mail: [nae\\_sales@gennum.com](mailto:nae_sales@gennum.com)**KOREA**8F Jinnex Lakeview Bldg.  
65-2, Bangidong, Songpagu  
Seoul, Korea 138-828

Phone: +82-2-414-2991

Fax: +82-2-414-2998

E-mail: [gennum-korea@gennum.com](mailto:gennum-korea@gennum.com)

---

Gennum Corporation assumes no liability for any errors or omissions in this document, or for the use of the circuits or devices described herein. The sale of the circuit or device described herein does not imply any patent license, and Gennum makes no representation that the circuit or device is free from patent infringement.

All other trademarks mentioned are the properties of their respective owners.

GENNUM and the Gennum logo are registered trademarks of Gennum Corporation.

© Copyright 2006 Gennum Corporation. All rights reserved.

[www.gennum.com](http://www.gennum.com)