

PROTECTION PRODUCTS - RailClamp®

Description

RailClamp® TVS arrays are ultra low capacitance ESD protection devices designed to protect high speed data interfaces. This series has been specifically designed to protect sensitive components which are connected to high-speed data and transmission lines from overvoltage caused by **ESD** (electrostatic discharge), **CDE** (Cable Discharge Events), and **EFT** (electrical fast transients).

The RClamp®7528T has a typical capacitance of only 0.25pF between I/O pins. This allows it to be used on circuits operating in excess of 3GHz without signal attenuation.

The RClamp7528T is in a 9-pin SLP2611N9T package. It measures 2.6 x 1.1mm with a nominal height of 0.40mm. The innovative flow through package design simplifies pcb layout and maximizes signal integrity on high-speed lines. Each device will protect eight lines and requires less board space than existing solutions.

The combination of small size, low capacitance, and high level of ESD protection makes this device a flexible solution for applications such as HDMI, MHL, MDDI, and eSATA interfaces.

Features

- ◆ ESD protection for high-speed data lines to **IEC 61000-4-2 (ESD) ±25kV (air), ±20kV (contact)**
- ◆ **IEC 61000-4-5 (Lightning) 5A (8/20µs)**
- ◆ **IEC 61000-4-4 (EFT) 40A (5/50ns)**
- ◆ Package design optimized for high speed lines
- ◆ Flow-Through design
- ◆ Protects eight high-speed lines
- ◆ Low capacitance: **0.25pF** typical (I/O to I/O)
- ◆ Low ESD clamping voltage
- ◆ Extremely low dynamic resistance: 0.30 Ohms (Typ)
- ◆ Solid-state silicon-avalanche technology

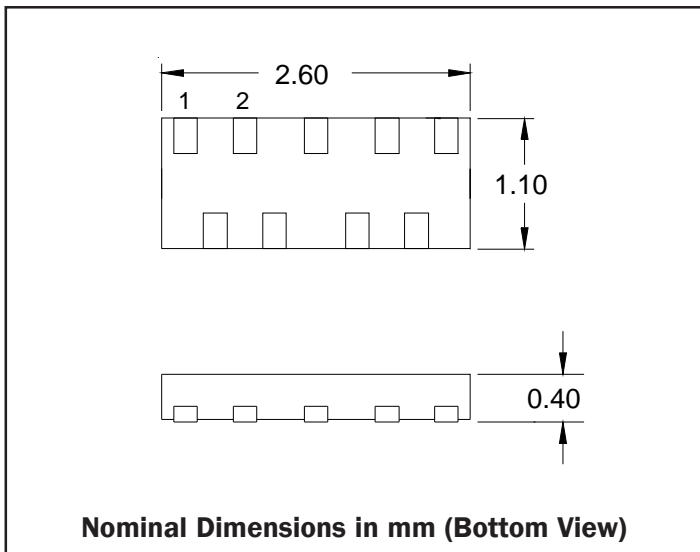
Mechanical Characteristics

- ◆ SLP2611N9T 9-pin package (2.6 x 1.1 x 0.40mm)
- ◆ Pb-Free, Halogen Free, RoHS/WEEE Compliant
- ◆ Lead Pitch: 0.50mm
- ◆ Lead finish: NiPdAu
- ◆ Marking: Marking Code
- ◆ Packaging: Tape and Reel

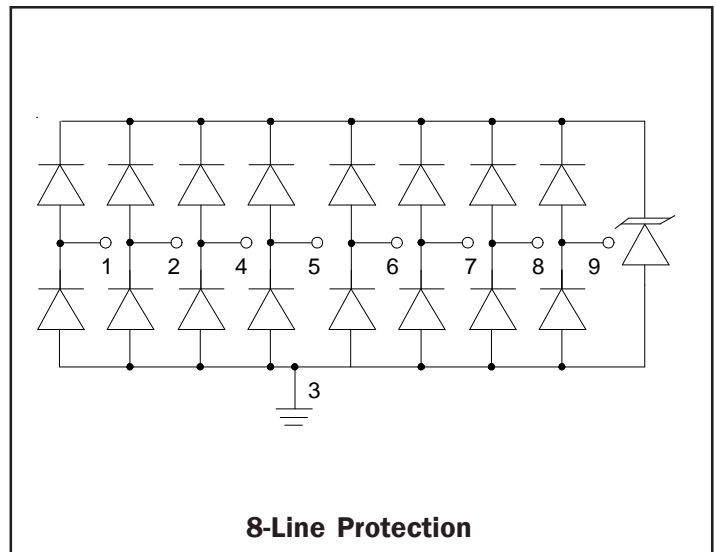
Applications

- ◆ HDMI 1.4
- ◆ USB 3.0
- ◆ MHL
- ◆ LVDS Interfaces
- ◆ PCI Express
- ◆ eSATA Interfaces

Dimensions



Circuit Diagram

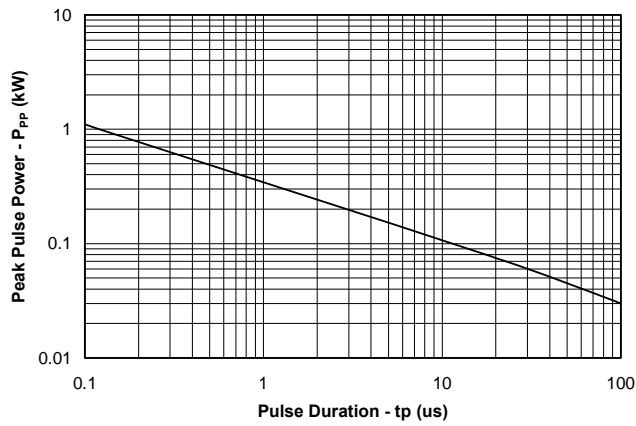
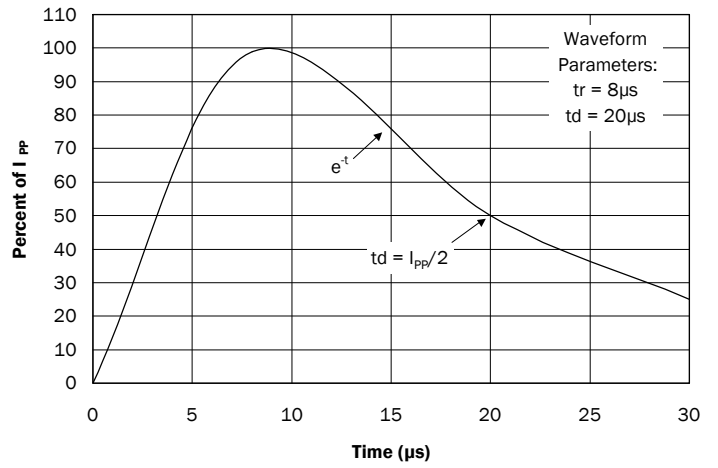
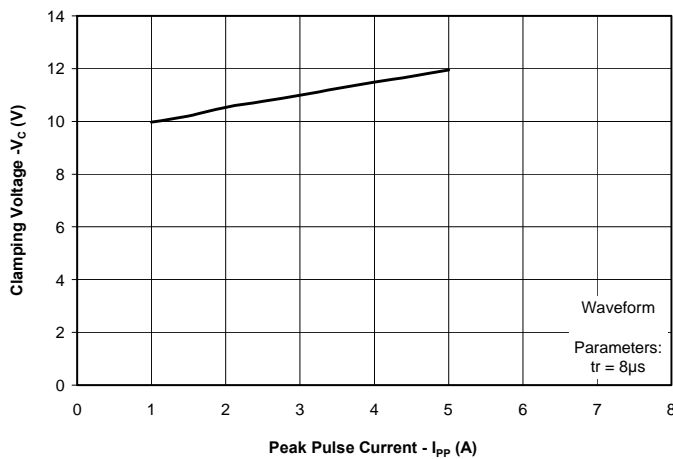
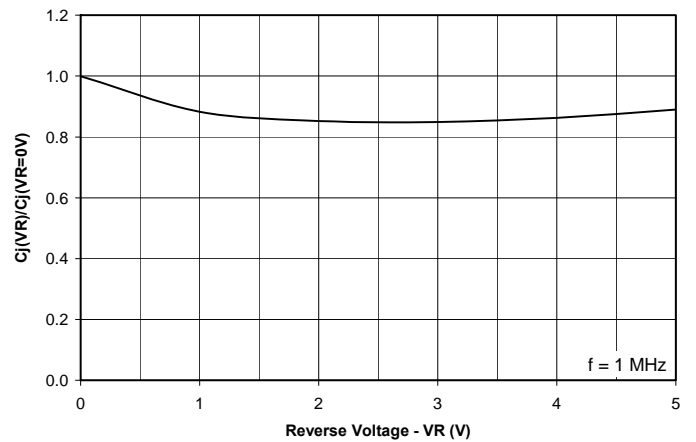


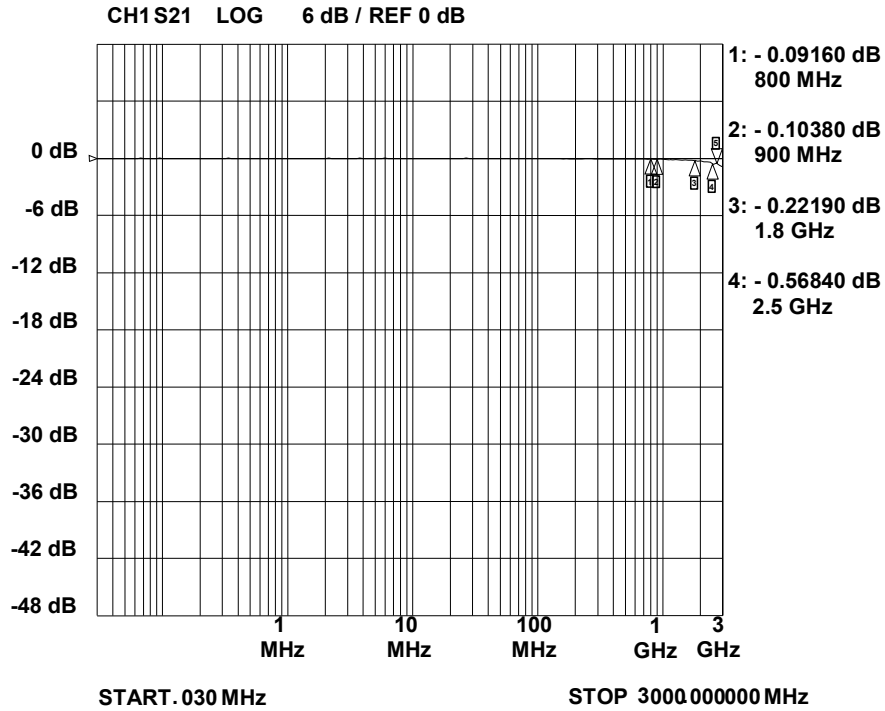
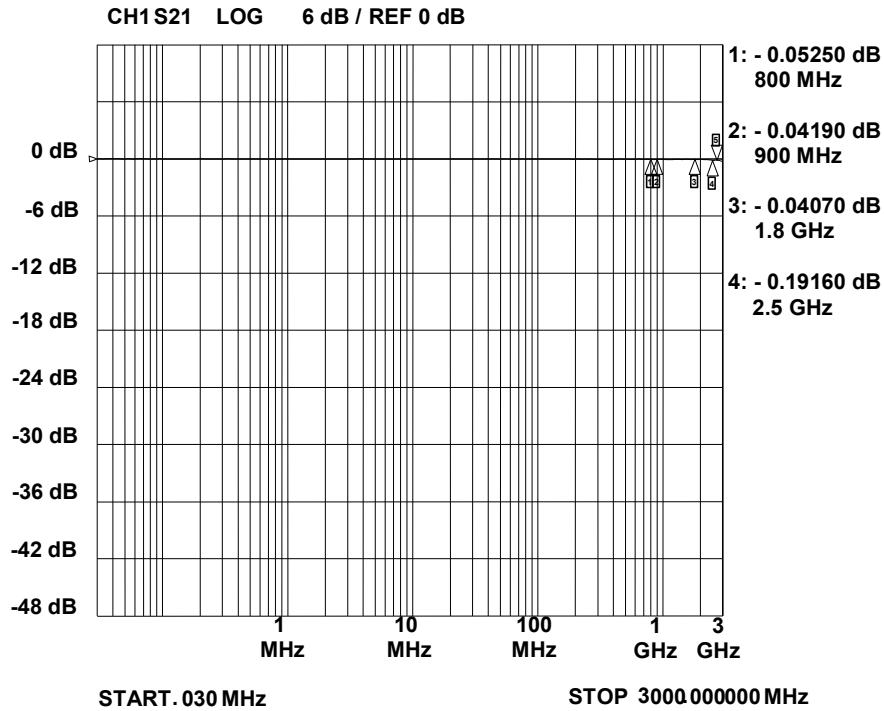
PROTECTION PRODUCTS
Absolute Maximum Rating

Rating	Symbol	Value	Units
Peak Pulse Power (tp = 8/20μs)	P_{pk}	75	Watts
Peak Pulse Current (tp = 8/20μs)	I_{pp}	5	A
ESD per IEC 61000-4-2 (Air) ESD per IEC 61000-4-2 (Contact)	V_{ESD}	+/- 25 +/- 20	kV
Operating Temperature	T_J	-55 to +125	°C
Storage Temperature	T_{STG}	-55 to +150	°C

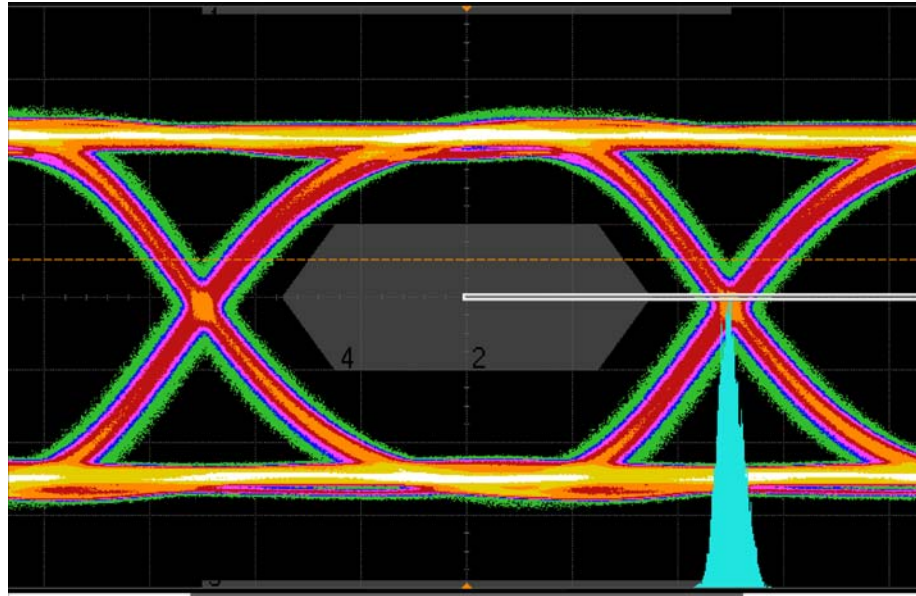
Electrical Characteristics (T=25°C)

Parameter	Symbol	Conditions	Minimum	Typical	Maximum	Units
Reverse Stand-Off Voltage	V_{RWM}	Any I/O to GND			5	V
Reverse Breakdown Voltage	V_{BR}	$I_t = 1mA$, Any I/O to GND	6.5	9	11	V
Reverse Leakage Current	I_R	$V_{RWM} = 5.0V$, Any I/O to GND		0.005	0.100	μA
Clamping Voltage	V_C	$I_{pp} = 1A$, tp = 8/20μs Any I/O to GND			12	V
Clamping Voltage	V_C	$I_{pp} = 5A$, tp = 8/20μs Any I/O to GND			15	V
Junction Capacitance	C_j	$V_R = 0V$, f = 1MHz, Any I/O to GND		0.50	0.60	pF
		$V_R = 0V$, f = 1MHz, Between I/O pins		0.25	0.4	pF

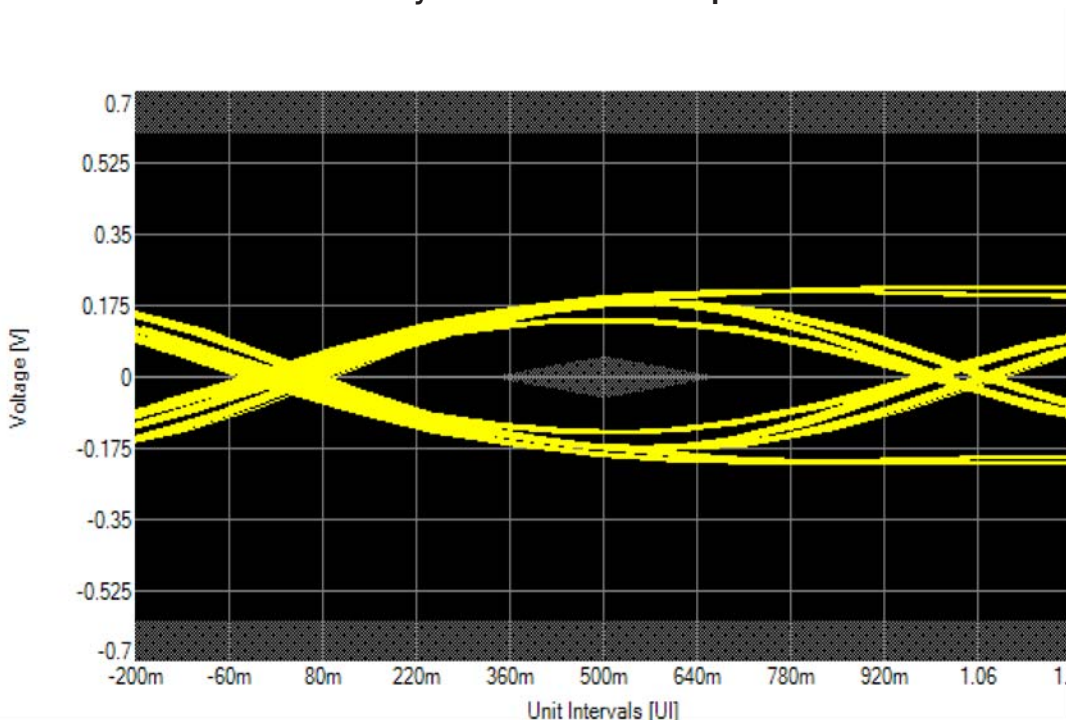
PROTECTION PRODUCTS
Typical Characteristics
Non-Repetitive Peak Pulse Power vs. Pulse Time

Pulse Waveform

**Clamping Voltage vs. Peak Pulse Current
(Between any I/O and Ground)**

Normalized Capacitance vs. Reverse Voltage


Insertion Loss S21 - I/O to GND

Insertion Loss S21 - I/O to I/O


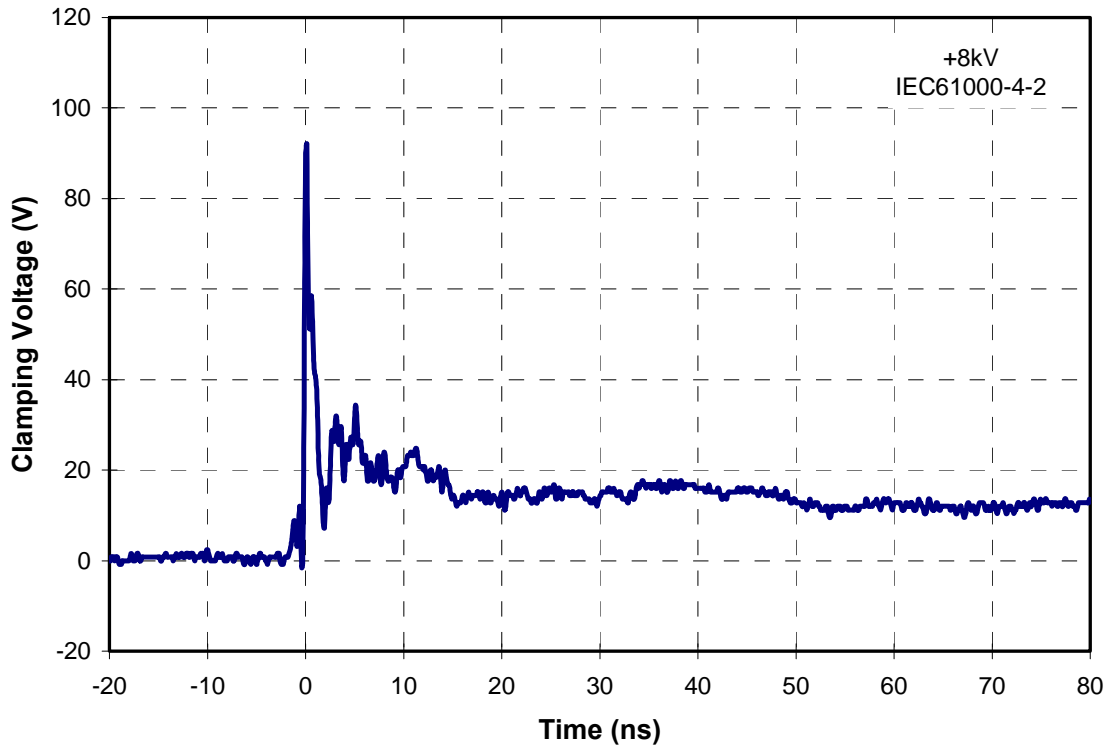
HDMI 1.4 Eye Pattern with RClamp7528T



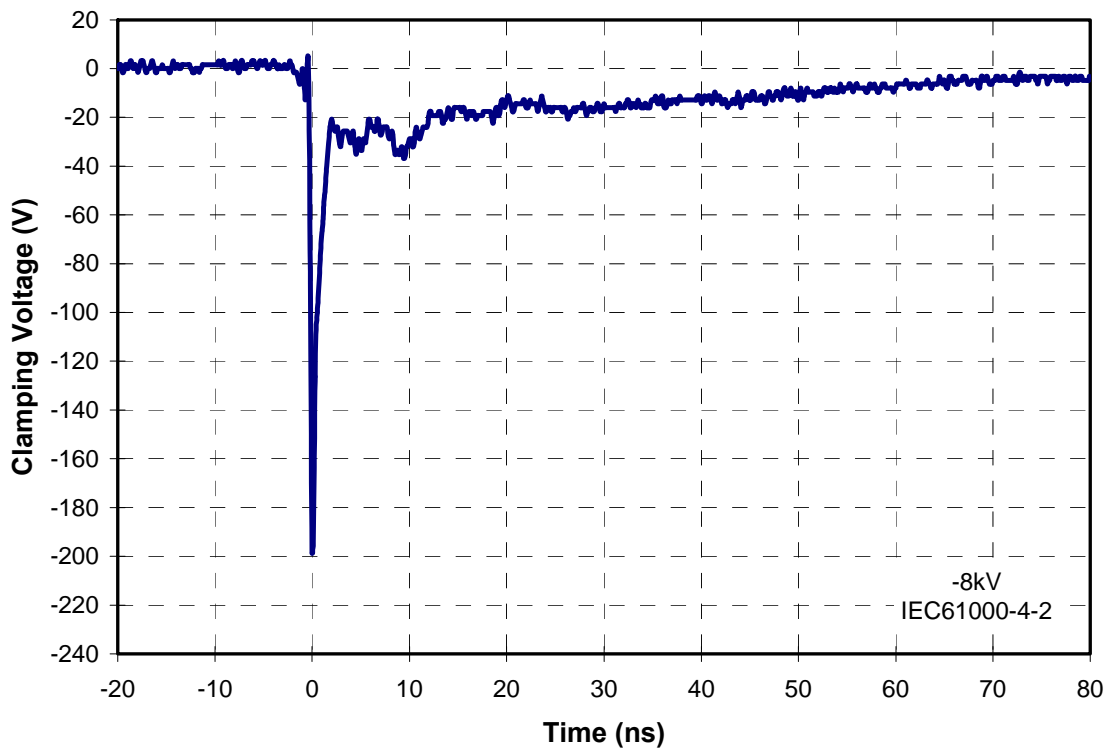
USB 3.0 Eye Pattern with RClamp7528T



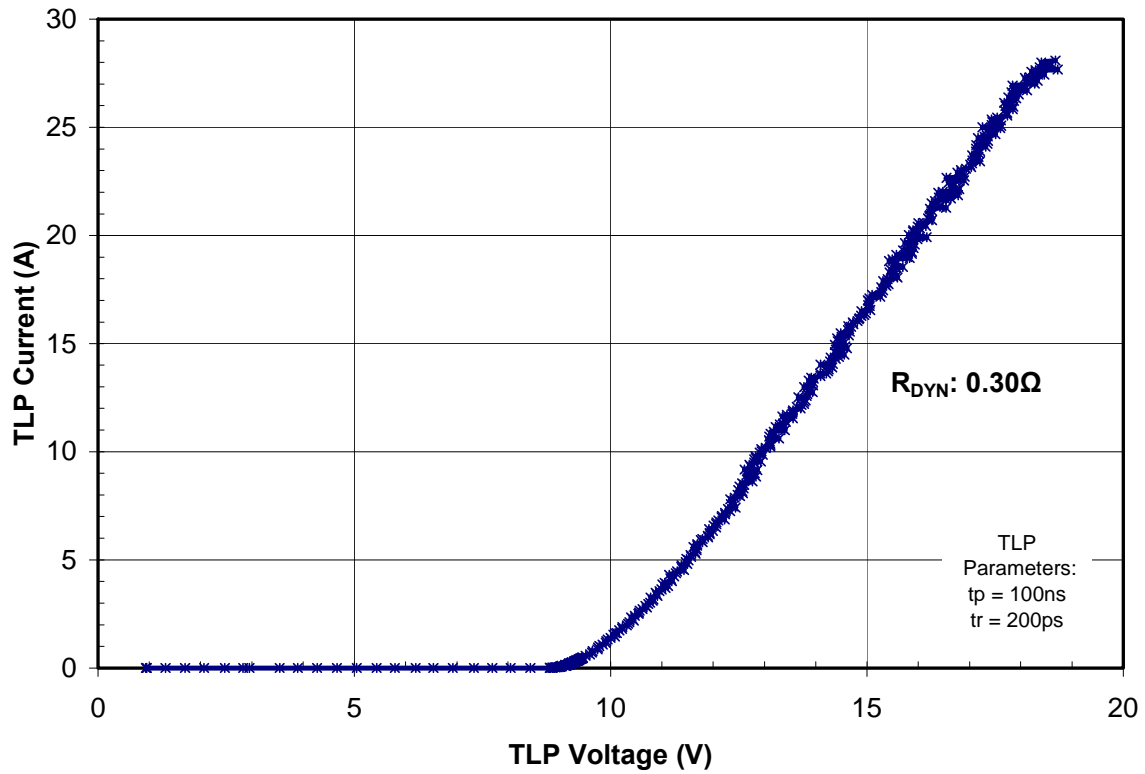
ESD Clamping (+8kV Contact per IEC 61000-4-2)



ESD Clamping (-8kV Contact per IEC 61000-4-2)



TLP Characteristic

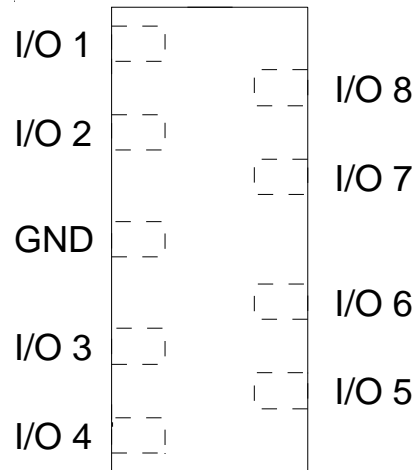
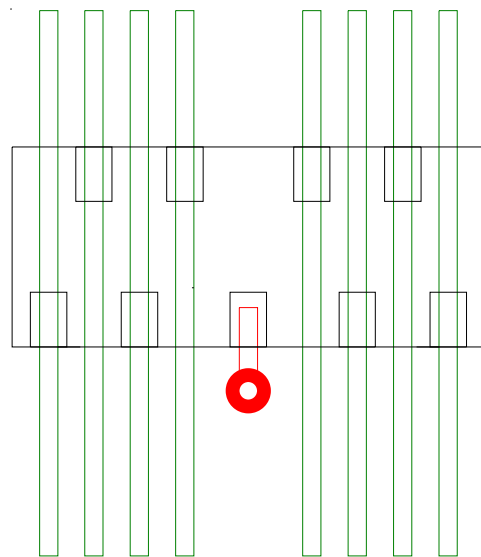


Design Recommendations for HDMI Protection

Adding external ESD protection to HDMI ports can be challenging. First, ESD protection devices have an inherent junction capacitance. Furthermore, adding even a small amount of capacitance will cause the impedance of the differential pair to drop. Second, large packages and land pattern requirements cause discontinuities that adversely affect signal integrity. The RClamp7528T is specifically designed for protection of high-speed interfaces such as HDMI. They present <math><0.25\text{pF}</math> capacitance between the pairs while being rated to handle >math> \pm 20\text{kV}</math> ESD contact discharges (>math> \pm 25\text{kV}</math> air discharge) as outlined in IEC 61000-4-2. Each device is in a leadless SLP package that is nominally 1.1mm wide. They are designed such that the traces flow straight through the device. The narrow package and flow-through design reduces discontinuities and minimizes impact on signal integrity. This becomes even more critical as signal speeds increase.

Pin Configuration

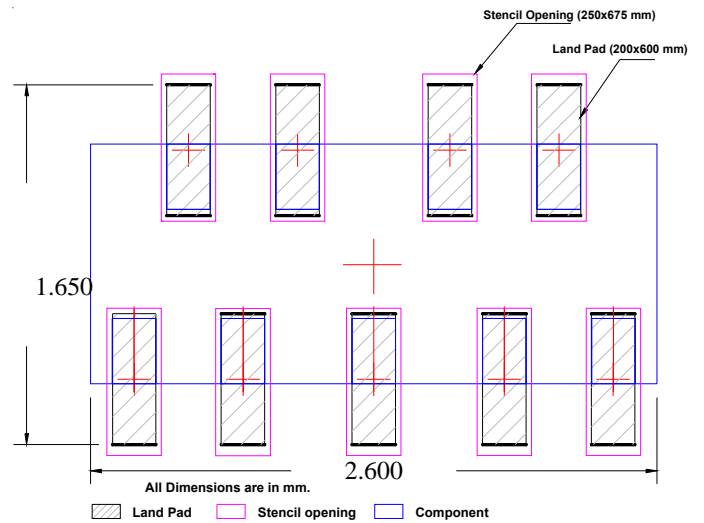
Figure 2 is an example of how to route the high speed differential traces through the RClamp7528T. The PCB traces enter and exit each I/O pin. The package is designed such that the trace-to-trace spacing can be kept at 0.100mm minimum when using 0.100mm wide traces. Ground is connected at pin 3.

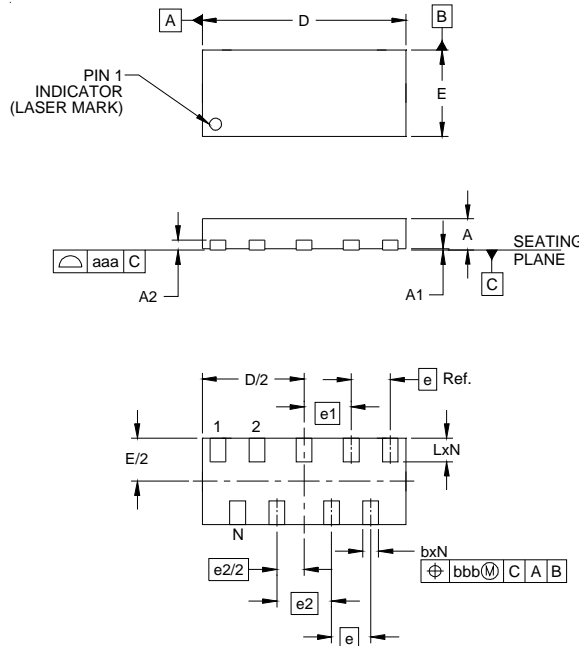

Figure 1 - Pin Configuration (Top View)

Figure 2 - Flow through Layout Using RClamp7528T

Assembly Guidelines

The small size of this device means that some care must be taken during the mounting process to insure reliable solder joint. The table below provides Semtech's recommended assembly guidelines for mounting this device. The figure at the right details Semtech's recommended aperture based on the below recommendations. Note that these are only recommendations and should serve only as a starting point for design since there are many factors that affect the assembly process. The exact manufacturing parameters will require some experimentation to get the desired solder application.

Assembly Parameter	Recommendation
Solder Stencil Design	Laser cut, Electro-polished
Aperture shape	Rectangular
Solder Stencil Thickness	0.100 mm (0.004")
Solder Paste Type	Type 3 size sphere or smaller
Solder Reflow Profile	Per JEDEC J-STD-020
PCB Solder Pad Design	Non-Solder mask defined
PCB Pad Finish	OSP OR NiAu

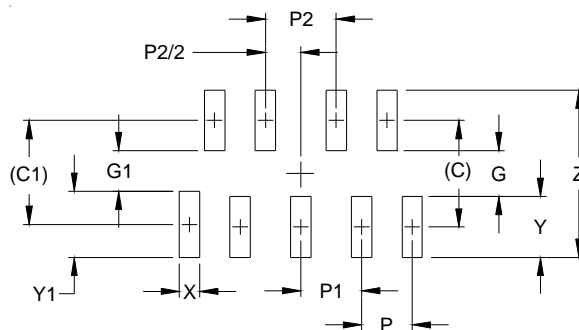

Recommended Mounting Pattern

PROTECTION PRODUCTS
Outline Drawing - SLP2611N9T


DIM	DIMENSIONS		
	MILLIMETERS		
	MIN	NOM	MAX
A	0.37	0.40	0.43
A1	0.00	0.02	0.05
A2	(0.13)		
b	0.15	0.20	0.25
D	2.50	2.60	2.70
E	1.00	1.10	1.20
e	0.50 BSC		
e1	0.60 BSC		
e2	0.70 BSC		
L	0.25	0.30	0.35
N	9		
aaa	0.08		
bbb	0.10		

NOTES:

1. CONTROLLING DIMENSIONS ARE IN MILLIMETERS (ANGLES IN DEGREES).

Land Pattern - SLP2611N9T


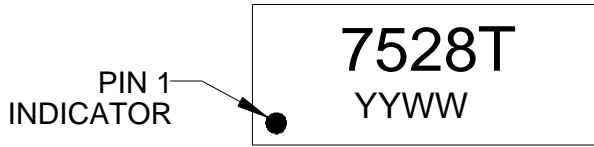
DIM	DIMENSIONS	
	MILLIMETERS	
C	(1.05)	
C1	(1.025)	
G	0.45	
G1	0.40	
P	0.50	
P1	0.60	
P2	0.70	
X	0.20	
Y	0.60	
Y1	0.65	
Z	1.65	

NOTES:

1. CONTROLLING DIMENSIONS ARE IN MILLIMETERS (ANGLES IN DEGREES).
2. THIS LAND PATTERN IS FOR REFERENCE PURPOSES ONLY. CONSULT YOUR MANUFACTURING GROUP TO ENSURE YOUR COMPANY'S MANUFACTURING GUIDELINES ARE MET.

PROTECTION PRODUCTS

Marking Codes



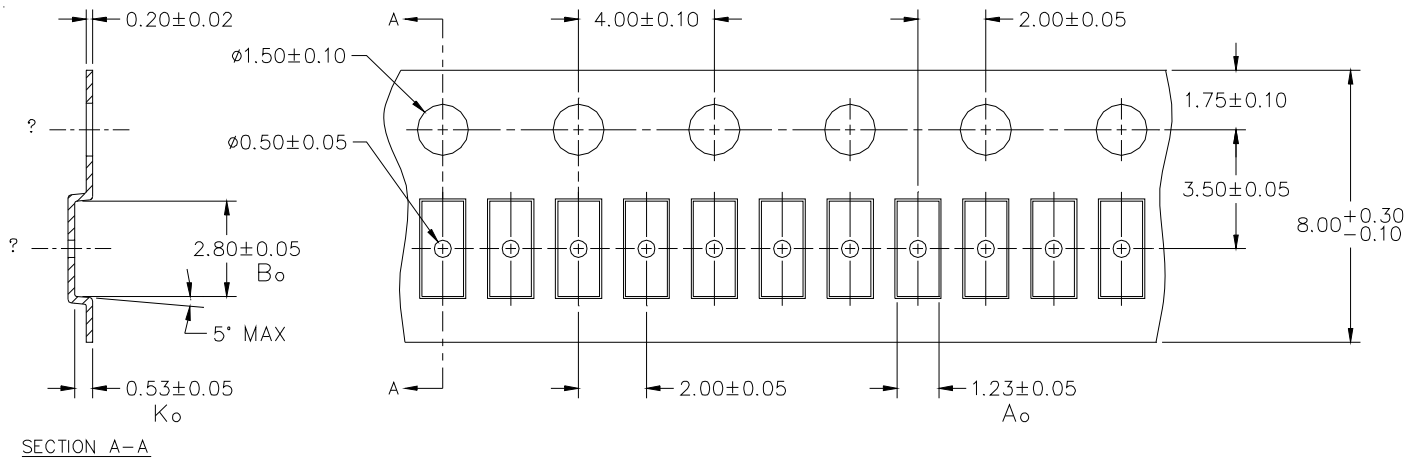
YYWW = Date Code

Ordering Information

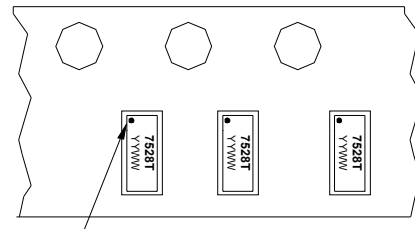
Part Number	Qty per Reel	Reel Size
RClamp7528T.TNT	10,000	7 Inch

RailClamp and RClamp are trademarks of Semtech Corporation.

Carrier Tape Specification



NOTES: ALL DIMENSIONS IN MILLIMETERS UNLESS OTHERWISE SPECIFIED.



Pin 1 Location (Towards Sprocket Holes)

→
User Direction of feed

Device Orientation in Tape

Contact Information

Semtech Corporation
 Protection Products Division
 200 Flynn Road, Camarillo, CA 93012
 Phone: (805)498-2111 FAX (805)498-3804