

AAT3510/3515/3517/3518

Micropower μP Reset with Watchdog Timer

General Description

The AAT351x PowerManager products are members of Skyworks' Total Power Management IC (TPMIC™) product family. This family of microprocessor reset circuits provides the ultimate in versatility, allowing system designers full customization of the μP monitor and reset function without any additional components. The AAT351x family offers several combinations of threshold voltage, watchdog timeout period, reset active period, and output drive configurations, which are all factory-programmed options. All devices are available in 32 reset threshold voltages from 2.6V up to 5V, with three watchdog timeout periods from 6.3ms to 1600ms and three reset timeouts from 1ms up to 140ms. Available output configurations are active low push-pull, active low open drain, active low bi-directional, and active high push-pull.

The AAT351x family is designed to ignore fast negative transients on V_{DD} and to ensure that reset outputs remain valid down to 1V.

The AAT351x family is available in the Pb-free, space-saving 5-pin SOT23 surface mount package and is specified over the -40 to +85°C temperature range.

Features

- Tight Voltage Tolerance: $\pm 1.5\%$
- Low Quiescent Current: 5 μA
- Guaranteed Reset Valid Down to 1V
- 32 Voltage Options from 2.6V to 5.0V
- Three Reset Active Period Options:
 - 1ms, 20ms, 140ms
- Three Watchdog Timeout Period Options:
 - 6.3ms, 102ms, 1600ms
- Four Output Options:
 - Open Drain
 - Inverting
 - Non-Inverting
 - Bi-Directional
- Low Temperature Coefficient: 100ppm/°C
- 5-Pin SOT23 Package

Applications

- Critical μP and μC Supply Monitoring
- Embedded Control Systems
- Industrial Controllers
- Intelligent Instruments
- Notebook Computers
- Portable Electronics
- Power-On Reset Circuits

Typical Application

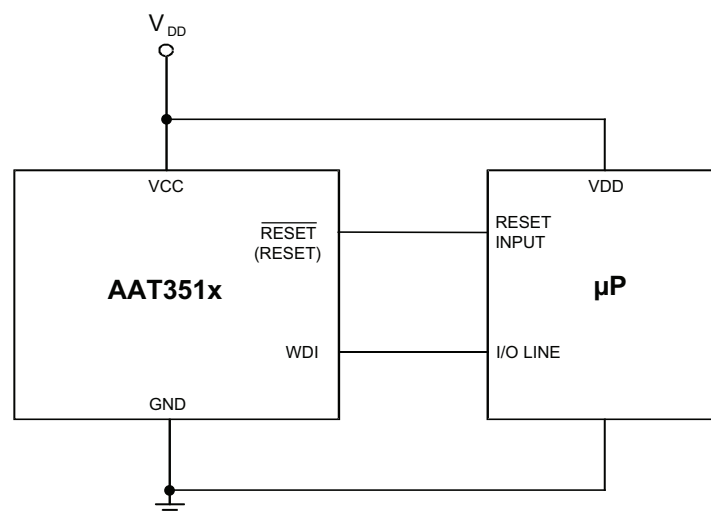

AAT3510/3515/3517/3518

Micropower μ P Reset with Watchdog Timer

Pin Descriptions

Pin Number			Symbol	Function
AAT3510 AAT3517	AAT3515	AAT3518		
1	1	1	$\overline{\text{RESET}}$	AAT3510/15: $\overline{\text{RESET}}$ output goes low whenever V_{DD} falls below the reset threshold. CMOS push-pull output. AAT3517: $\overline{\text{RESET}}$ output goes low whenever V_{DD} falls below the reset threshold. Open drain output. Connect a pull-up resistor to any supply voltage up to 5.5V. AAT3518: $\overline{\text{RESET}}$ output goes low whenever V_{DD} falls below the reset threshold. Open drain output. Connect a pull-up resistor to any supply voltage up to 5.5V.
2	2	2	GND	Ground connection pin.
N/A	3	3	RESET	RESET active-high output. This CMOS push-pull signal is the logical inverse of $\overline{\text{RESET}}$.
3	4	N/A	$\overline{\text{MR}}$	Manual reset input pin. Active low. Pull low to force a reset.
4	N/A	4	WDI	Watchdog input pin. Triggers a reset if it remains in a steady state for the duration of the watchdog timer period.
5	5	5	VCC	Input voltage pin.

Pin Configuration

5-lead SOT23
(Top View)

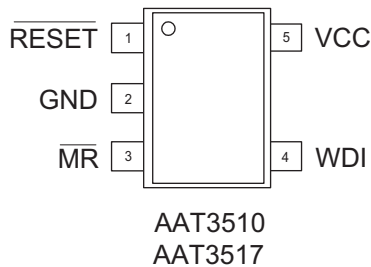

5-lead SOT23
(Top View)

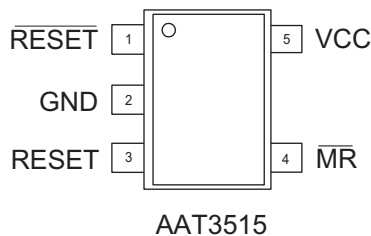

5-lead SOT23
(Top View)

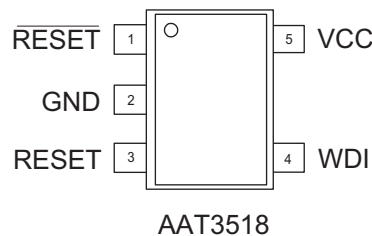

AAT3510/3515/3517/3518

Micropower μ P Reset with Watchdog Timer

Absolute Maximum Ratings¹

 $T_A = 25^\circ\text{C}$, unless otherwise noted.

Symbol	Description	Max	Units
V_{CC}	V_{CC} to GND	-0.3 to 6	V
V_{MR}, V_{WDI}	$\overline{MR}, \overline{WDI}$ to GND	-0.3 to $V_{CC} + 0.3$	
V_{RESET}	\overline{RESET} to GND (Push-Pull or Bidirectional Output) \overline{RESET} to GND (Open Drain Output)		
I_{VCC}, I_{MR}, I_{WDI}	Maximum Continuous Input Current	20	mA
I_{RESET}	$\overline{RESET}/\overline{RESET}$ Output Current	100	V/ μs
dV_{CC}/dt	Rate of Rise of V_{CC}	150	$^\circ\text{C}$
T_J	Operating Junction Temperature Range (-40 $^\circ\text{C}$ to +150 $^\circ\text{C}$)		

Thermal Information²

Symbol	Description	Value	Units
Θ_{JA}	Maximum Thermal Resistance	190	$^\circ\text{C}/\text{W}$
P_D	Maximum Power Dissipation	526	mW

- Stresses above those listed in Absolute Maximum Ratings may cause permanent damage to the device. Functional operation at conditions other than the operating conditions specified is not implied.
- Mounted on an FR4 board.

AAT3510/3515/3517/3518

Micropower μ P Reset with Watchdog Timer

Electrical Characteristics

$V_{CC} = 2.5V$ to $5.5V$, $T_A = -40^{\circ}C$ to $+85^{\circ}C^1$, unless otherwise noted. Typical values are at $T_A = 25^{\circ}C$.

Symbol	Description	Conditions	Min	Typ	Max	Units
V_{CC}	Operating Voltage Range	$T_A = -40^{\circ}C$ to $+85^{\circ}C$	1		5.5	V
I_{CC}	Supply Current	AAT3510/7/8: \overline{MR} & WDI Unconnected	$V_{CC} = 3.6V$	5	15	μA
			$V_{CC} = 5.5V$	6	18	
		AAT3515: MR Unconnected	$V_{CC} = 3.6V$		15	
			$V_{CC} = 5.5V$		18	
V_{TH}	Reset Threshold Voltage	$T_A = 25^{\circ}C$	$V_{THNOM} - 1.5\%$	V_{TH}	$V_{THNOM} + 1.5\%$	V
		$T_A = -40$ to $+85^{\circ}C$	$V_{THNOM} - 2.5\%$		$V_{THNOM} + 2.5\%$	
T_C	Reference Voltage Temperature Coefficient	$-40^{\circ}C < T_A < +85^{\circ}C$		± 40		ppm/ $^{\circ}C$
t_{RP}	Reset Active Timeout Period	AAT351xIGV-xx-B-x-T1	20	28	40	ms
		AAT351xIGV-xx-C-x-T1	140	200	280	
T_{RD}	V_{CC} to RESET Delay	V_{CC} Falling at $1mV/\mu s$		40		μs
Push/Pull RESET Output (AAT3510, 3515, 3518)						
V_{OL}	\overline{RESET} Low Output Voltage	$V_{CC} \geq 1.0V, I_{SINK} = 50\mu A$			0.3	V
		$V_{CC} \geq 1.2V, I_{SINK} = 100\mu A$				
		$V_{CC} \geq 2.7V, I_{SINK} = 1.2mA$			0.4	
		$V_{CC} \geq 4.5V, I_{SINK} = 3.2mA$				
V_{OH}	\overline{RESET} High Output Voltage	$V_{CC} \geq 2.7V, I_{SOURCE} = 500\mu A$	$0.8 \times V_{CC}$			
		$V_{CC} \geq 4.5V, I_{SOURCE} = 800\mu A$	$V_{CC} - 1.5$			
V_{OH}	RESET Low Output Voltage	$V_{CC} \geq 2.7V, I_{SINK} = 1.2mA$			0.3	
		$V_{CC} \geq 4.5V, I_{SINK} = 3.2mA$			0.4	
	RESET High Output Voltage	$V_{CC} \geq 1.8V, I_{SOURCE} = 150\mu A$	$0.8 \times V_{CC}$			
		$V_{CC} \geq 2.7V, I_{SOURCE} = 500\mu A$				
		$V_{CC} \geq 4.5V, I_{SOURCE} = 800\mu A$	$V_{CC} - 1.5$			

1. Over-temperature limits are guaranteed by design, not production tested.

AAT3510/3515/3517/3518

Micropower μ P Reset with Watchdog Timer

Electrical Characteristics

$V_{CC} = 2.5V$ to $5.5V$, $T_A = -40^\circ C$ to $+85^\circ C$ ¹, unless otherwise noted. Typical values are at $T_A = 25^\circ C$.

Symbol	Description	Conditions	Min	Typ	Max	Units
Open-Drain RESET Output (AAT3517, 3518)						
V_{OL}	RESET Low Output Voltage	$V_{CC} \geq 1.0V, I_{SINK} = 50\mu A$			0.3	V
		$V_{CC} \geq 1.2V, I_{SINK} = 100\mu A$				
		$V_{CC} \geq 2.7V, I_{SINK} = 1.2mA$				
		$V_{CC} \geq 4.5V, I_{SINK} = 3.2mA$			0.4	
$I_{D(OFF)}$	Reset Leakage Current				1.0	μA
Watchdog Input (AAT3510, 3517, 3518)						
t_{WD}	Watchdog Timeout Period	AAT351xIGV-xx-x-B-T1	71	102	153	ms
		AAT351xIGV-xx-x-C-T1 ²	1.12	1.6	2.4	s
t_{WDI}	WDI Minimum Pulse Width	$V_{IL} = 0.3 \times V_{CC}, V_{IH} = 0.7 \times V_{CC}$		50		ns
V_{IL}	WDI Input Threshold ³		$0.3 \times V_{CC}$			
V_{IH}					$0.8 \times V_{CC}$	V
I_{WDI}	WDI Input Current ⁴	WDI = V_{CC} , Time Average		120	160	μA
		$V_{WDI} = 0$, Time Average	-20	-15		
Manual RESET Input (3515)						
V_{IL}	MR Input Threshold		$0.3 \times V_{CC}$			
V_{IH}	MR Input Threshold				$0.7 \times V_{CC}$	V
	MR Input Pulse Width		1			μs
	MR Glitch Rejection			100		ns
	MR Internal Pull-Up Resistance	$T_A = 25^\circ C$	35	52	75	$k\Omega$
	MR to Reset Delay	$V_{CC} = 5V$			230	ns

1. Over-temperature limits are guaranteed by design, not production tested.

2. Watchdog timeout period C is not available on AAT3518.

3. WDI is internally serviced within the watchdog period if WDI is left unconnected.

4. The WDI input current is specified as the average input current when the WDI input is driven high or low. The WDI input is designed for a three-stated-output device with a $10\mu A$ maximum leakage current and capable of driving a maximum capacitive load of 200pF. The three-state device must be able to source and sink at least $200\mu A$ when active.

AAT3510/3515/3517/3518

Micropower μP Reset with Watchdog Timer

Typical Characteristics

Unless otherwise noted, $V_{IN} = 3V$, $T_A = 25^\circ C$.

Supply Current vs. Temperature

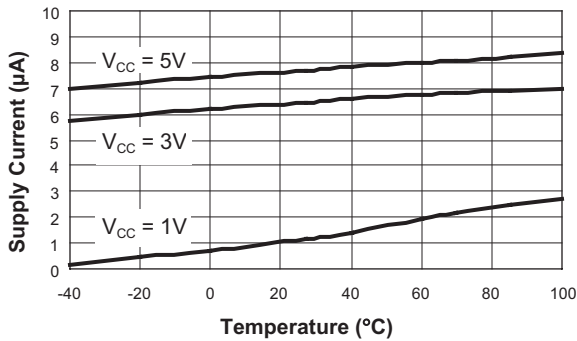

V_{CC} Falling to RESET Propagation Delay vs. Temperature

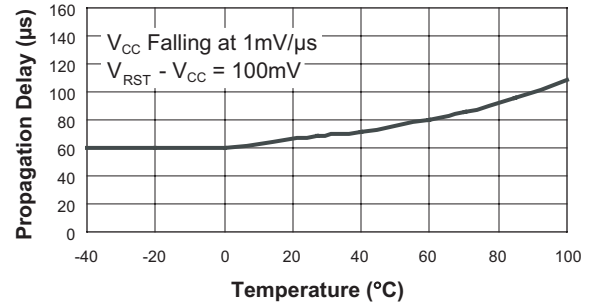

Manual Reset to RESET Propagation Delay vs. Temperature

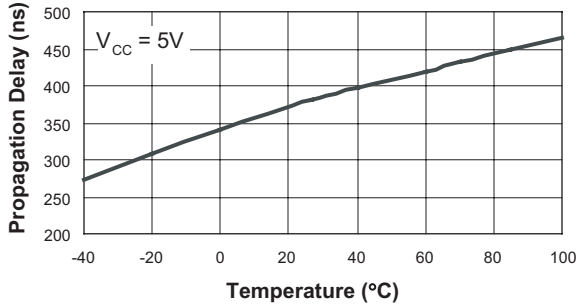

Normalized Reset Timeout Period vs. Temperature

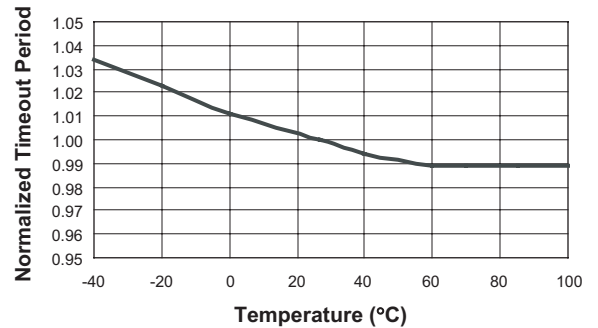

Normalized Watchdog Timeout Period vs. Temperature

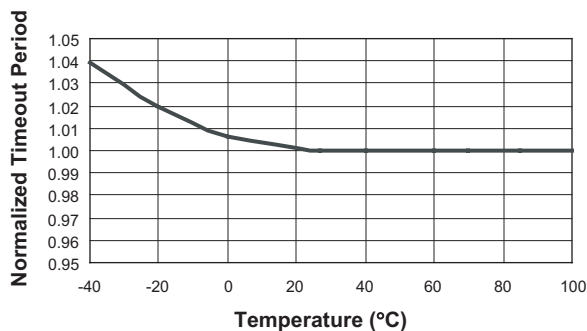

Maximum V_{CC} Transient Duration vs. Reset Threshold Overdrive

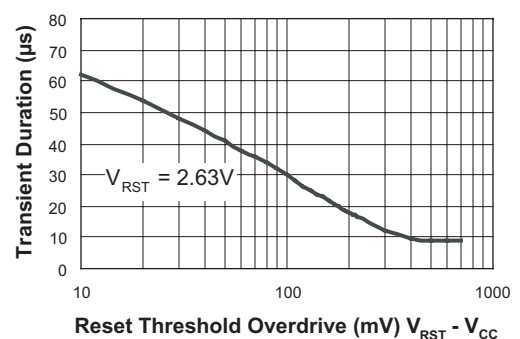

AAT3510/3515/3517/3518

Micropower μ P Reset with Watchdog Timer

Typical Characteristics

Unless otherwise noted, $V_{IN} = 3V$, $T_A = 25^\circ C$.

Bidirectional Pullup Characteristic

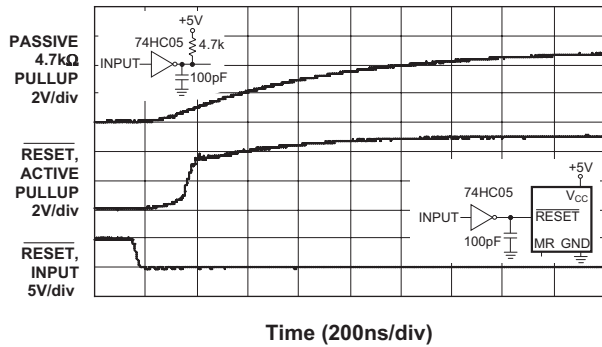

AAT3510/3515/3517/3518

Micropower μ P Reset with Watchdog Timer

Functional Block Diagram

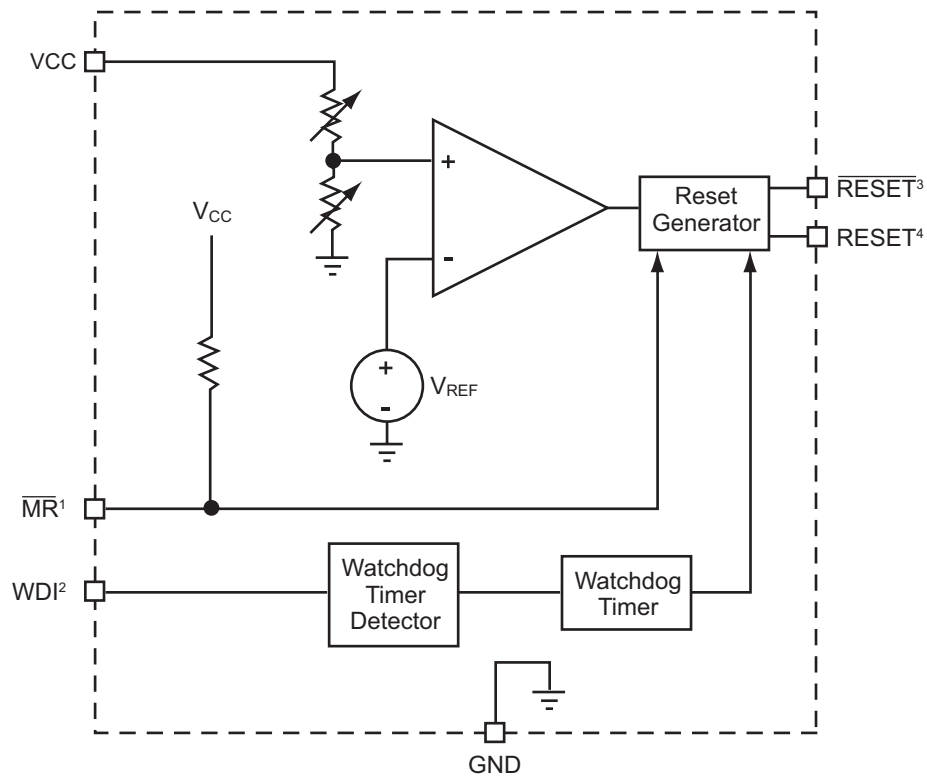

1. MR pin available on AAT3510/5/7.
2. WDI pin available on AAT3510/7/8.
3. RESET pin available on AAT3510/5/7/8.
4. RESET pin available on AAT3515/8.

AAT3510/3515/3517/3518

Micropower μ P Reset with Watchdog Timer

Factory-Trimmed Reset Thresholds¹ and Ordering Information

AAT351x IGV-X.XX-X-X-T1

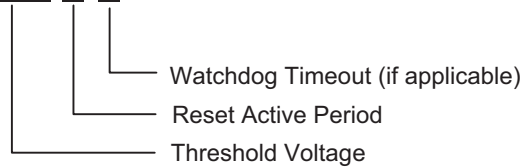

Reset Active Period

A: $T_{R(MIN)} = 1\text{ms}$

B: $T_{R(MIN)} = 20\text{ms}$

C: $T_{R(MIN)} = 140\text{ms}$

Watchdog Timeout Period

A: $T_{WD(NOM)} = 6.3\text{ms}$

B: $T_{WD(NOM)} = 102\text{ms}$

C: $T_{WD(NOM)} = 1600\text{ms}$ ¹

VDD Threshold Voltage

2.63: $V_{TH(NOM)} = 2.63\text{V}$

2.70: $V_{TH(NOM)} = 2.7\text{V}$

2.80: $V_{TH(NOM)} = 2.8\text{V}$

2.93: $V_{TH(NOM)} = 2.93\text{V}$

3.00: $V_{TH(NOM)} = 3.0\text{V}$

3.08: $V_{TH(NOM)} = 3.08\text{V}$

3.20: $V_{TH(NOM)} = 3.2\text{V}$

3.30: $V_{TH(NOM)} = 3.3\text{V}$

3.40: $V_{TH(NOM)} = 3.4\text{V}$

3.50: $V_{TH(NOM)} = 3.5\text{V}$

3.60: $V_{TH(NOM)} = 3.6\text{V}$

3.70: $V_{TH(NOM)} = 3.7\text{V}$

3.80: $V_{TH(NOM)} = 3.8\text{V}$

3.90: $V_{TH(NOM)} = 3.9\text{V}$

4.00: $V_{TH(NOM)} = 4.0\text{V}$

4.10: $V_{TH(NOM)} = 4.1\text{V}$

4.20: $V_{TH(NOM)} = 4.2\text{V}$

4.38: $V_{TH(NOM)} = 4.3\text{V}$

4.40: $V_{TH(NOM)} = 4.38\text{V}$

4.50: $V_{TH(NOM)} = 4.5\text{V}$

4.63: $V_{TH(NOM)} = 4.63\text{V}$

4.70: $V_{TH(NOM)} = 4.7\text{V}$

4.80: $V_{TH(NOM)} = 4.8\text{V}$

4.90: $V_{TH(NOM)} = 4.9\text{V}$

5.00: $V_{TH(NOM)} = 5.0\text{V}$

1. Watchdog timeout period C is not available on AAT3518.

AAT3510/3515/3517/3518

Micropower μ P Reset with Watchdog Timer

Ordering Information

Package	Marking ¹	Part Number (Tape and Reel) ²
SOT23-5	HVXY	AAT3510IGV-2.63-C-C-T1
	HUXY	AAT3510IGV-2.93-C-C-T1
	HGY	AAT3510IGV-3.08-C-C-T1
	HHXY	AAT3510IGV-4.38-C-C-T1
	HEXY	AAT3515IGV-2.63-C-T1
	HIXY	AAT3515IGV-2.93-B-T1
	KLXY	AAT3515IGV-2.93-C-T1
	JNXY	AAT3515IGV-3.08-C-T1
	KMXY	AAT3515IGV-4.38-C-T1
	MFXY	AAT3515IGV-4.63-C-T1
	INXY	AAT3517IGV-2.63-C-C-T1
	LZXY	AAT3517IGV-2.8-B-C-T1
	IQXY	AAT3517IGV-2.93-C-C-T1
	P9XY	AAT3518IGV-3.00-B-B-T1

 Skyworks Green™ products are compliant with all applicable legislation and are halogen-free. For additional information, refer to Skyworks Definition of Green™, document number SQ04-0074.

Package Information

SOT23-5

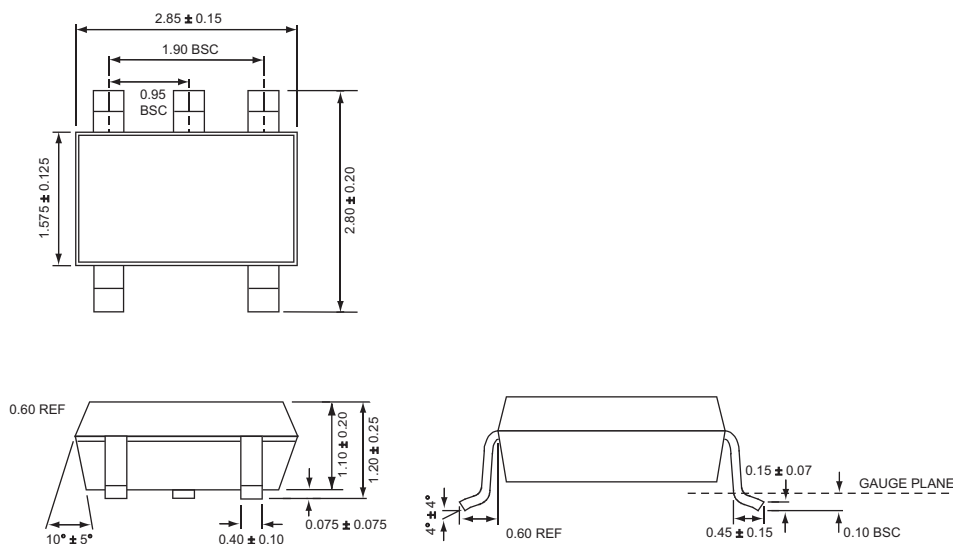

All dimensions in millimeters.

1. XYY = date and assembly code.
2. Sample stock is generally held on part numbers listed in **BOLD**.

AAT35 I 0/35 I 5/35 I 7/35 I 8

Micropower μ P Reset with Watchdog Timer

Copyright © 2012 Skyworks Solutions, Inc. All Rights Reserved.

Information in this document is provided in connection with Skyworks Solutions, Inc. ("Skyworks") products or services. These materials, including the information contained herein, are provided by Skyworks as a service to its customers and may be used for informational purposes only by the customer. Skyworks assumes no responsibility for errors or omissions in these materials or the information contained herein. Skyworks may change its documentation, products, services, specifications or product descriptions at any time, without notice. Skyworks makes no commitment to update the materials or information and shall have no responsibility whatsoever for conflicts, incompatibilities, or other difficulties arising from any future changes.

No license, whether express, implied, by estoppel or otherwise, is granted to any intellectual property rights by this document. Skyworks assumes no liability for any materials, products or information provided hereunder, including the sale, distribution, reproduction or use of Skyworks products, information or materials, except as may be provided in Skyworks Terms and Conditions of Sale.

THE MATERIALS, PRODUCTS AND INFORMATION ARE PROVIDED "AS IS" WITHOUT WARRANTY OF ANY KIND, WHETHER EXPRESS, IMPLIED, STATUTORY, OR OTHERWISE, INCLUDING FITNESS FOR A PARTICULAR PURPOSE OR USE, MERCHANTABILITY, PERFORMANCE, QUALITY OR NON-INFRINGEMENT OF ANY INTELLECTUAL PROPERTY RIGHT; ALL SUCH WARRANTIES ARE HEREBY EXPRESSLY DISCLAIMED. SKYWORKS DOES NOT WARRANT THE ACCURACY OR COMPLETENESS OF THE INFORMATION, TEXT, GRAPHICS OR OTHER ITEMS CONTAINED WITHIN THESE MATERIALS. SKYWORKS SHALL NOT BE LIABLE FOR ANY DAMAGES, INCLUDING BUT NOT LIMITED TO ANY SPECIAL, INDIRECT, INCIDENTAL, STATUTORY, OR CONSEQUENTIAL DAMAGES, INCLUDING WITHOUT LIMITATION, LOST REVENUES OR LOST PROFITS THAT MAY RESULT FROM THE USE OF THE MATERIALS OR INFORMATION, WHETHER OR NOT THE RECIPIENT OF MATERIALS HAS BEEN ADVISED OF THE POSSIBILITY OF SUCH DAMAGE.

Skyworks products are not intended for use in medical, lifesaving or life-sustaining applications, or other equipment in which the failure of the Skyworks products could lead to personal injury, death, physical or environmental damage. Skyworks customers using or selling Skyworks products for use in such applications do so at their own risk and agree to fully indemnify Skyworks for any damages resulting from such improper use or sale.

Customers are responsible for their products and applications using Skyworks products, which may deviate from published specifications as a result of design defects, errors, or operation of products outside of published parameters or design specifications. Customers should include design and operating safeguards to minimize these and other risks. Skyworks assumes no liability for applications assistance, customer product design, or damage to any equipment resulting from the use of Skyworks products outside of stated published specifications or parameters.

Skyworks, the Skyworks symbol, and "Breakthrough Simplicity" are trademarks or registered trademarks of Skyworks Solutions, Inc., in the United States and other countries. Third-party brands and names are for identification purposes only, and are the property of their respective owners. Additional information, including relevant terms and conditions, posted at www.skyworksinc.com, are incorporated by reference.