

DATA SHEET

SMV123x Series: Hyperabrupt Junction Tuning Varactors

Applications

- Low tuning voltage VCOs
- High-Q resonators in wireless system VCOs
- High-volume commercial systems

Features

- High capacitance ratio
- Low series resistance for low phase noise
- Packages rated MSL1, 260 °C per JEDEC J-STD-020



Skyworks Green™ products are compliant with all applicable legislation and are halogen-free. For additional information, refer to *Skyworks Definition of Green™*, document number SQ04-0074.



Description

The SMV123x series of silicon hyperabrupt junction varactor diodes are designed for use in Voltage Controlled Oscillators (VCOs) with a low tuning voltage operation. The low resistance of these varactors makes them appropriate for high-Q resonators in wireless system VCOs to frequencies over 10 GHz. This family of varactors is characterized for capacitance and resistance over temperature.

Table 1 describes the various packages and markings of the SMV123x varactors.

Table 1. Packaging and Marking

Single	Single	Single	Common Cathode	Common Anode	Common Cathode	Single
SC-79 Green™	SOD-323 Green™	SOT-23	SOT-23	SC-70	SC-70	SOD-882 Green™
					SMV1231-074 Marking: JA3	
SMV1231-079LF Marking: Cathode	SMV1231-011LF Marking: KA				SMV1231-074LF Green™ Marking: KA3	SMV1231-040LF Marking: A
SMV1232-079LF Marking: Cathode	SMV1232-011LF Marking: HC					SMV1232-040LF Marking: Y
		SMV1233-001 Marking: VP1	SMV1233-004 Marking: VP3			
SMV1233-079LF Marking: Cathode	◆ SMV1233-011LF Marking: DP	SMV1233-001LF Green™ Marking: DP1	SMV1233-004LF Green™ Marking: DP3			SMV1233-040LF Marking: B
		SMV1234-001 Marking: VQ1	SMV1234-004 Marking: VQ3	SMV1234-073 Marking: VQ9		
SMV1234-079LF Marking: Cathode	◆ SMV1234-011LF Marking: DQ	SMV1234-001LF Green™ Marking: DQ1	SMV1234-004LF Green™ Marking: DQ3	SMV1234-073LF Green™ Marking: DQ9		SMV1234-040LF Marking: G
		SMV1235-001 Marking: VR1	SMV1235-004 Marking: VR3			
SMV1235-079LF Marking: Cathode	SMV1235-011LF Marking: DR	SMV1235-001LF Green™ Marking: DR1	SMV1235-004LF Green™ Marking: DR3			SMV1235-040LF Marking: M
		SMV1236-001 Marking: AQ1	SMV1236-004 Marking: AQ3			
◆ SMV1236-079LF Marking: Cathode	SMV1236-011LF Marking: EQ	SMV1236-001LF Green™ Marking: EQ1	SMV1236-004LF Green™ Marking: EQ3			SMV1236-040LF Marking: R
		SMV1237-001 Marking: VT1				
		SMV1237-001LF Green™ Marking: DT1				
Ls = 0.7 nH	Ls = 1.5 nH	Ls = 1.5 nH	Ls = 1.5 nH	Ls = 1.4 nH	Ls = 1.4 nH	Ls = 0.45 nH



The Pb-free symbol or "LF" in the part number denotes a lead-free, RoHS-compliant package unless otherwise noted as Green™. Tin/lead (Sn/Pb) packaging is not recommended for new designs.



Innovation to Go™

Select Linear Products (indicated by ◆) now available for purchase online.

Electrical and Mechanical Specifications

The absolute maximum ratings of the SMV123x varactors are provided in Table 2. Electrical specifications are provided in Table 3. Typical capacitance values are listed in Table 4. Typical performance characteristics of the SMV123x varactors are illustrated in Figures 1 through 4.

The SPICE model for the SMV123x varactors is shown in Figure 5 and the associated model parameters are provided in Table 5.

Package dimensions are shown in Figures 6 to 14 (even numbers), and tape and reel dimensions are provided in Figures 7 to 15 (odd numbers).

Package and Handling Information

Instructions on the shipping container label regarding exposure to moisture after the container seal is broken must be followed. Otherwise, problems related to moisture absorption may occur when the part is subjected to high temperature during solder assembly.

The SMV123x series of varactors are rated to Moisture Sensitivity Level 1 (MSL1) at 260 °C. They can be used for lead or lead-free soldering. For additional information, refer to the Skyworks Application Note, *Solder Reflow Information*, document number 200164.

Care must be taken when attaching this product, whether it is done manually or in a production solder reflow environment. Production quantities of this product are shipped in a standard tape and reel format.

Table 2. SMV123x Absolute Maximum Ratings (Note 1)

Parameter	Symbol	Minimum	Maximum	Units
Reverse voltage	V_R		15	V
Forward current	I_F		20	mA
Power dissipation	P_{DIS}		250	mW
Operating temperature	T_{OP}	-55	+125	°C
Storage temperature	T_{STG}	-55	+150	°C
Electrostatic discharge: Human Body Model (HBM), Class 1B	ESD		1000	V

Note 1: Exposure to maximum rating conditions for extended periods may reduce device reliability. There is no damage to device with only one parameter set at the limit and all other parameters set at or below their nominal value. Exceeding any of the limits listed here may result in permanent damage to the device.

CAUTION: Although this device is designed to be as robust as possible, electrostatic discharge (ESD) can damage this device. This device must be protected at all times from ESD. Static charges may easily produce potentials of several kilovolts on the human body or equipment, which can discharge without detection. Industry-standard ESD precautions should be used at all times.

Table 3. SMV123x Electrical Specifications (Note 1)
 (TOP = 25 °C, Unless Otherwise Noted)

Part Number	C _T @ 1 V (pF)		C _T @ 3 V (pF)	C _T @ 6 V (pF)	C _T @ 1 V / C _T @ 3 V (Ratio)		C _T @ 1 V / C _T @ 6 V (Ratio)		Rs @ 3 V, 500 MHz (Ω)
	Min.	Max.	Typ.	Typ.	Min.	Max.	Min.	Max.	Typ.
SMV1231	1.43	1.72	0.97	0.61	1.5	1.8	2.5	2.8	2.90
SMV1232	2.34	2.86	1.50	0.94	1.5	1.9	2.6	3.3	1.50
SMV1233	3.00	3.60	1.80	1.10	1.5	1.9	2.6	3.3	1.20
SMV1234	5.85	7.15	3.60	2.00	1.6	2.0	2.8	3.4	0.80
SMV1235	10.35	12.65	6.40	3.60	1.6	2.0	2.9	3.4	0.60
SMV1236	15.50	18.50	9.20	5.30	1.6	2.0	3.0	3.5	0.50
SMV1237	45.00	54.00	26.90	14.40	1.6	2.0	3.0	3.5	0.40

Note 1: Performance is guaranteed only under the conditions listed in this Table.

Tested with -079 package.

Reverse voltage V_R (I_R = 10 μA) = 15 V minimum

Reverse current I_R (V_R = 12 V) = 20 nA maximum

Table 4. Capacitance vs Reverse Voltage

V _R (V)	C _T (pF)						
	SMV1231	SMV1232	SMV1233	SMV1234	SMV1235	SMV1236	SMV1237
0	2.35	4.15	5.08	9.63	18.22	26.75	71.82
0.5	1.87	3.22	3.95	7.53	14.12	20.61	56.10
1.0	1.58	2.67	3.28	6.28	11.67	17.02	46.89
1.5	1.40	2.28	2.80	5.39	9.91	14.38	40.33
2.0	1.22	1.97	2.41	4.68	8.52	12.29	35.13
2.5	1.09	1.72	2.09	4.09	7.36	10.56	30.71
3.0	0.970	1.51	1.82	3.58	6.40	9.16	26.87
3.5	0.882	1.35	1.62	3.15	5.62	8.04	23.57
4.0	0.794	1.22	1.45	2.81	4.99	7.19	20.83
4.5	0.732	1.13	1.33	2.54	4.50	6.53	18.62
5.0	0.683	1.05	1.24	2.32	4.11	6.01	16.87
5.5	0.648	0.99	1.16	2.15	3.80	5.61	15.48
6.0	0.613	0.94	1.10	2.02	3.55	5.28	14.36
6.5	0.590	0.90	1.05	1.90	3.34	5.02	13.46
7.0	0.567	0.86	1.01	1.80	3.17	4.81	12.72
7.5	0.551	0.84	0.98	1.72	3.03	4.64	12.11
8.0	0.534	0.81	0.96	1.65	2.91	4.49	11.61
9.0	0.512	0.78	0.92	1.55	2.73	4.28	10.87
10.0	0.497	0.76	0.90	1.47	2.61	4.13	10.38
11.0	0.492	0.75	0.88	1.42	2.53	4.02	10.06
12.0	0.487	0.74	0.87	1.38	2.47	3.95	9.84
13.0	0.480	0.73	0.86	1.35	2.43	3.89	9.68
14.0	0.472	0.73	0.85	1.33	2.40	3.84	9.56
15.0	0.466	0.72	0.84	1.32	2.38	3.80	9.47

Typical Performance Characteristics

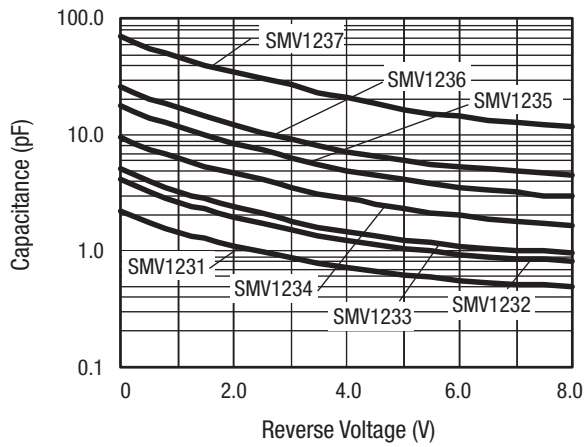

Figure 1. Capacitance vs Reverse Voltage

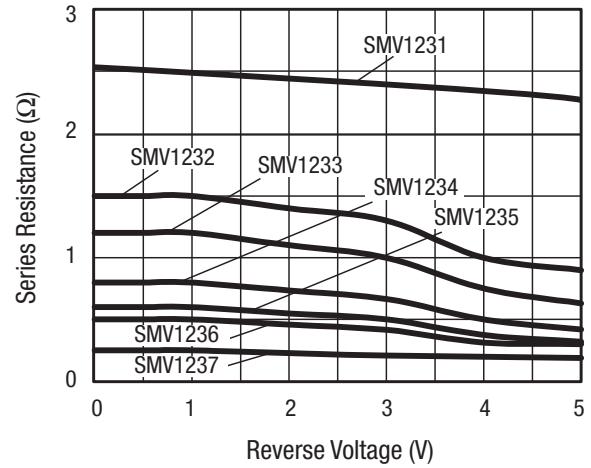

Figure 2. Series Resistance vs Reverse Voltage @ 500 MHz

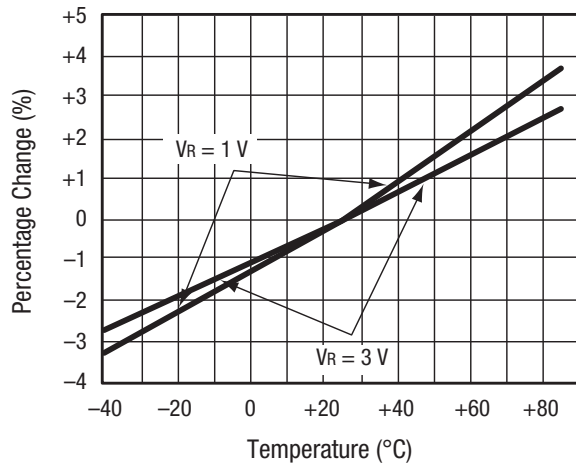

Figure 3. Relative Capacitance Change vs Temperature

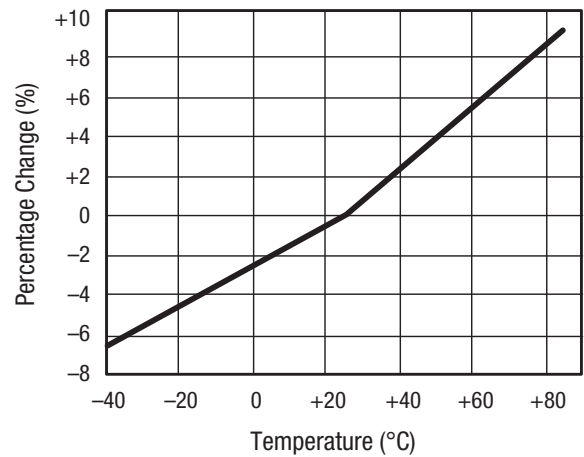

Figure 4. Relative Series Resistance Change vs Temperature @ 500 MHz

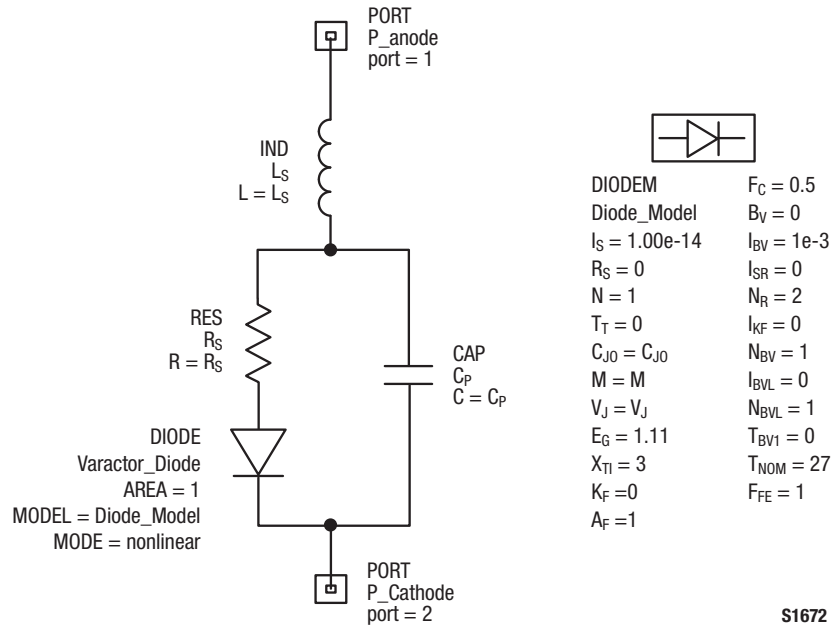

Figure 5. SPICE Model

Table 5. SPICE Model Parameters

Part Number	C _{J0} (pF)	V _J (V)	M	C _P (pF)	R _S (Ω)
SMV1231	1.88	10.13	4.999	0.44	2.50
SMV1232	3.43	8.36	4.690	0.68	1.50
SMV1233	4.21	11.87	6.430	0.81	1.20
SMV1234	8.36	7.95	3.960	1.15	0.80
SMV1235	15.85	8.78	4.570	2.15	0.60
SMV1236	22.89	9.62	5.230	3.59	0.50
SMV1237	61.40	14.51	6.780	8.90	0.25

Values extracted from measured performance.

For package inductance (L_s), refer to Table 1.

For more details, refer to the Skyworks Application Note, *Varactor SPICE Model for Approved RF VCO Applications*, document number 200315.

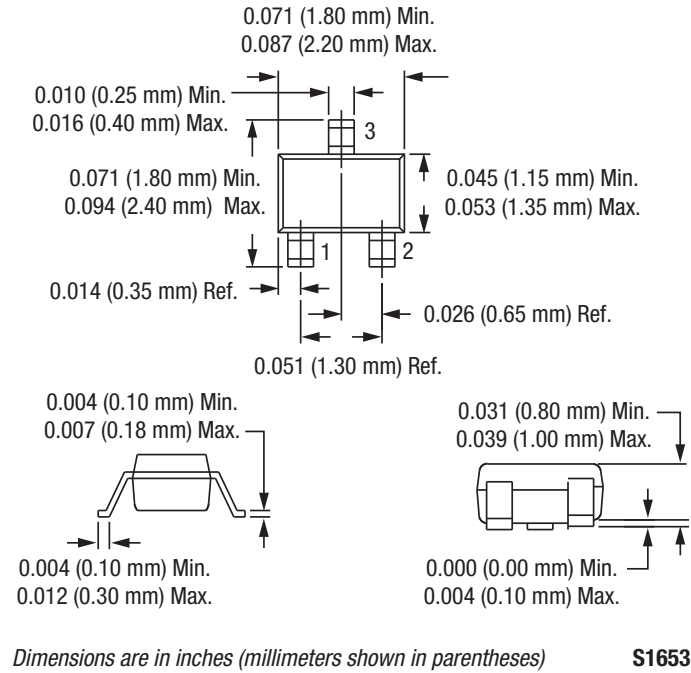
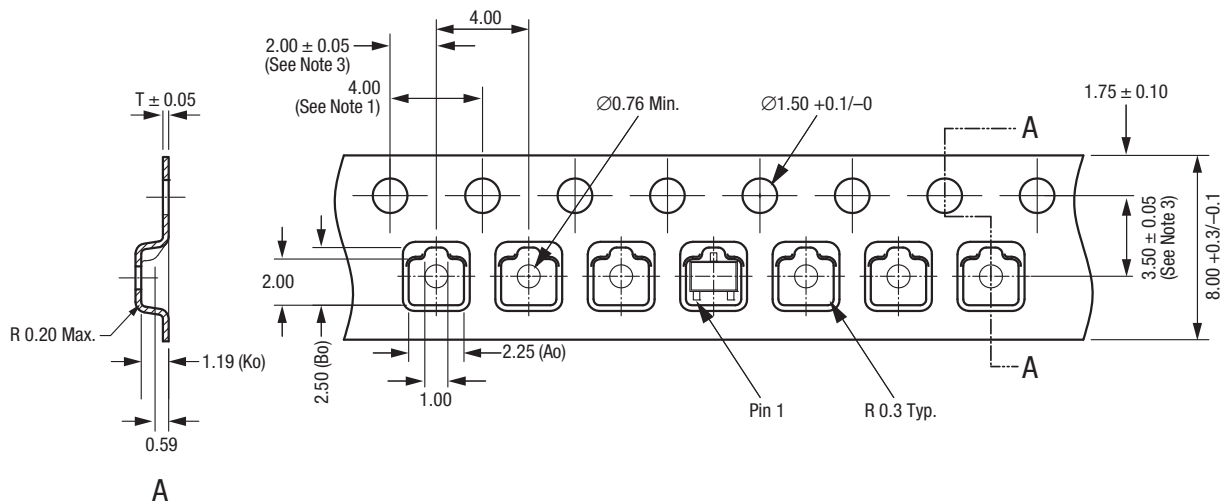

Figure 6. SC-70 Package Dimensions



- Notes:
1. Sprocket hole pitch cumulative tolerance ±0.2.
 2. Carrier tape: black conductive polystyrene.
 3. Pocket position relative to sprocket hole measured as true position of pocket, not pocket hole.
 4. Cover tape material: transparent conductive PSA with 9.2 mm width.
 5. All measurements are in millimeters.

S1685c

Figure 7. SC-70 Tape and Reel Dimensions

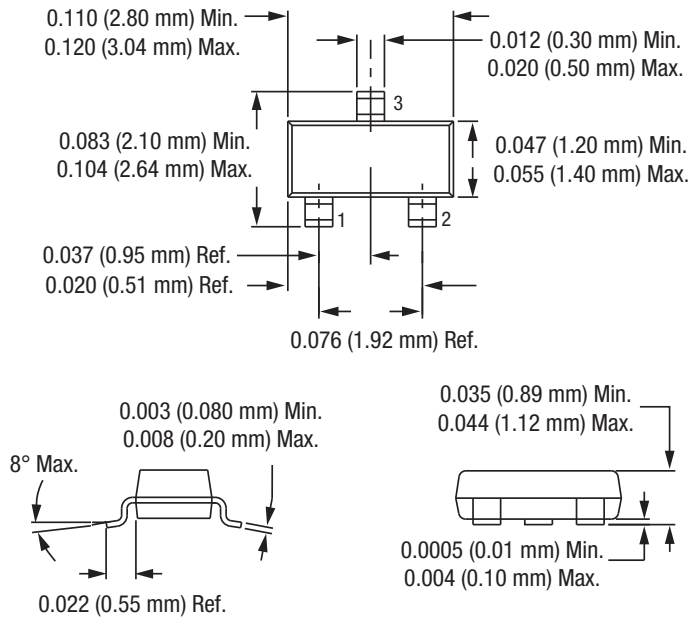

Dimensions are in inches (millimeters shown in parentheses)

S1389

Figure 12. SOT-23 Package Dimensions

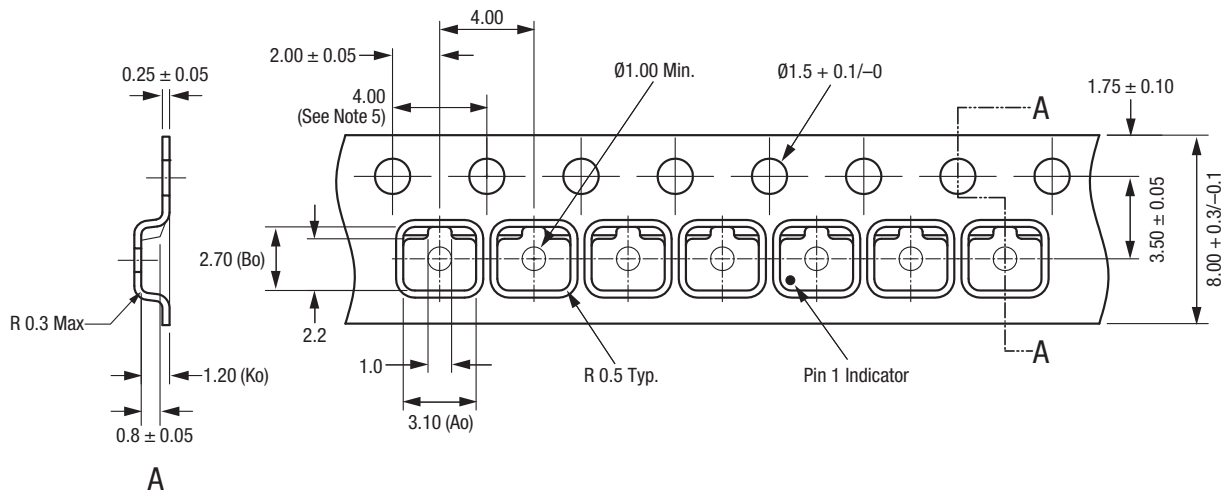

Notes:

1. Carrier tape: black conductive polycarbonate.
2. Cover tape material: transparent conductive PSA.
3. Cover tape size: 5.40 mm width.
4. Tolerance: ±0.10 mm.
5. Ten sprocket hole pitch cumulative tolerance: ±0.2 mm.
6. All measurements are in millimeters.

S1684b

Figure 13. SOT-23 Tape and Reel Dimensions

Copyright © 2002-2007, 2009-2012, 2014 Skyworks Solutions, Inc. All Rights Reserved.

Information in this document is provided in connection with Skyworks Solutions, Inc. ("Skyworks") products or services. These materials, including the information contained herein, are provided by Skyworks as a service to its customers and may be used for informational purposes only by the customer. Skyworks assumes no responsibility for errors or omissions in these materials or the information contained herein. Skyworks may change its documentation, products, services, specifications or product descriptions at any time, without notice. Skyworks makes no commitment to update the materials or information and shall have no responsibility whatsoever for conflicts, incompatibilities, or other difficulties arising from any future changes.

No license, whether express, implied, by estoppel or otherwise, is granted to any intellectual property rights by this document. Skyworks assumes no liability for any materials, products or information provided hereunder, including the sale, distribution, reproduction or use of Skyworks products, information or materials, except as may be provided in Skyworks Terms and Conditions of Sale.

THE MATERIALS, PRODUCTS AND INFORMATION ARE PROVIDED "AS IS" WITHOUT WARRANTY OF ANY KIND, WHETHER EXPRESS, IMPLIED, STATUTORY, OR OTHERWISE, INCLUDING FITNESS FOR A PARTICULAR PURPOSE OR USE, MERCHANTABILITY, PERFORMANCE, QUALITY OR NON-INFRINGEMENT OF ANY INTELLECTUAL PROPERTY RIGHT; ALL SUCH WARRANTIES ARE HEREBY EXPRESSLY DISCLAIMED. SKYWORKS DOES NOT WARRANT THE ACCURACY OR COMPLETENESS OF THE INFORMATION, TEXT, GRAPHICS OR OTHER ITEMS CONTAINED WITHIN THESE MATERIALS. SKYWORKS SHALL NOT BE LIABLE FOR ANY DAMAGES, INCLUDING BUT NOT LIMITED TO ANY SPECIAL, INDIRECT, INCIDENTAL, STATUTORY, OR CONSEQUENTIAL DAMAGES, INCLUDING WITHOUT LIMITATION, LOST REVENUES OR LOST PROFITS THAT MAY RESULT FROM THE USE OF THE MATERIALS OR INFORMATION, WHETHER OR NOT THE RECIPIENT OF MATERIALS HAS BEEN ADVISED OF THE POSSIBILITY OF SUCH DAMAGE.

Skyworks products are not intended for use in medical, lifesaving or life-sustaining applications, or other equipment in which the failure of the Skyworks products could lead to personal injury, death, physical or environmental damage. Skyworks customers using or selling Skyworks products for use in such applications do so at their own risk and agree to fully indemnify Skyworks for any damages resulting from such improper use or sale.

Customers are responsible for their products and applications using Skyworks products, which may deviate from published specifications as a result of design defects, errors, or operation of products outside of published parameters or design specifications. Customers should include design and operating safeguards to minimize these and other risks. Skyworks assumes no liability for applications assistance, customer product design, or damage to any equipment resulting from the use of Skyworks products outside of stated published specifications or parameters.

Skyworks and the Skyworks symbol are trademarks or registered trademarks of Skyworks Solutions, Inc., in the United States and other countries. Third-party brands and names are for identification purposes only, and are the property of their respective owners. Additional information, including relevant terms and conditions, posted at www.skyworksinc.com, are incorporated by reference.