

DATA SHEET

SKYA21001: 20 MHz to 3.0 GHz SPDT Switch

Automotive Applications

- Infotainment
- Automated toll systems
- Garage door opener
- 802.11 b/g/n WLAN, Bluetooth® systems
- Wireless control systems
- Outdoor lighting control
- Remote keyless entry
- Telematics
- GPS/Navigation

Features

- IP1dB = +30 dBm typical @ 3 V
- IP3 = +43 dBm typical @ 3 V
- Low insertion loss: 0.3 dB @ 0.9 GHz
- Low DC power consumption
- Ultra-miniature, SC-70 (6-pin, 2.00 x 1.25 mm) package
- Designed and manufactured in an ISO/TS16949-certified facility
- AEC-Q100 qualified
- JEDEC (JESD22) qualified at 25 °C
- Lead (Pb)-free and RoHS-compliant MSL-1 @ 260 °C per JEDEC J-STD-020



Skyworks Green™ products are compliant with all applicable legislation and are halogen-free. For additional information, refer to *Skyworks Definition of Green™*, document number SQ04-0074.

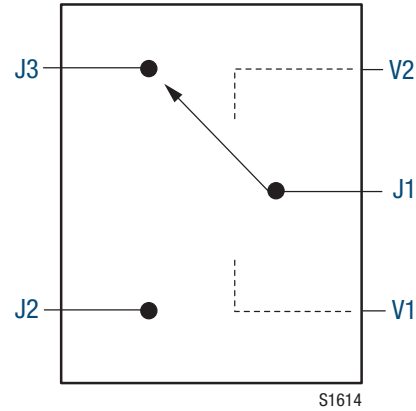

Figure 1. SKYA21001 Block Diagram

Description

The SKYA21001 is a single-pole, double-throw (SPDT) switch. The device features low insertion loss and positive voltage operation with very low DC power consumption. The SKYA21001 is manufactured in a compact 2.00 x 1.25 mm, 6-pin SC-70 package.

A functional block diagram is shown in Figure 1. The pin configuration and package are shown in Figure 2. Signal pin assignments and functional pin descriptions are provided in Table 1.

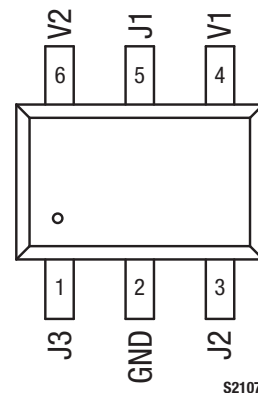

Figure 2. SKYA21001 Pinout – 6-Pin SC-70 (Top View)

Table 1. SKYA21001 Signal Descriptions

Pin	Name	Description	Pin	Name	Description
1	J3	RF output (Note 1)	4	V1	DC control voltage
2	GND	Ground	5	J1	RF output (Note 1)
3	J2	RF output (Note 1)	6	V2	DC control voltage

Note 1: A 100 pF blocking capacitor is required for >500 MHz operation. Use larger value capacitors for lower frequency operation.

Table 2. SKYA21001 Absolute Maximum Ratings (Note 1)

Parameter	Symbol	Minimum	Maximum	Units
Control voltage	V _{CTL}	-0.2	+8.0	V
RF input power (V _{CTL} = 0 to 7 V):				
>500 MHz			+36	dBm
<500 MHz			+27	dBm
Operating temperature	T _{OP}	-40	+105	°C
Storage temperature	T _{STG}	-65	+150	°C

Note 1: Exposure to maximum rating conditions for extended periods may reduce device reliability. There is no damage to device with only one parameter set at the limit and all other parameters set at or below their nominal value.

CAUTION: Although this device is designed to be as robust as possible, electrostatic discharge (ESD) can damage this device. This device must be protected at all times from ESD. Static charges may easily produce potentials of several kilovolts on the human body or equipment, which can discharge without detection. Industry-standard ESD precautions should be used at all times.

Table 3. SKYA21001 Electrical Specifications (Note 1)
($V_{CTL} = 0$ to 3 V, $T_{OP} = +25$ °C, Characteristic Impedance = 50 Ω , Unless Otherwise Noted)

Parameter	Symbol	Test Condition	Min	Typical	Max	Units
Insertion loss (Note 2, Note 3)	IL	0.7 to 1.0 GHz, 25°C		0.3	0.4	dB
		1.0 to 2.0 GHz, 25°C		0.4	0.5	dB
		2.0 to 3.0 GHz, 25°C		0.4	0.6	dB
Insertion loss (ETC) (Note 4)	IL	0.7 to 1.0 GHz, -40°C to 105 °C		0.35	0.45	dB
		1.0 to 2.0 GHz, -40°C to 105 °C		0.41	0.55	dB
		2.0 to 3.0 GHz, -40°C to 105 °C		0.46	0.7	dB
Isolation (Note 3)	ISO	0.7 to 1.0 GHz, 25°C	22	25		dB
		1.0 to 2.0 GHz, 25°C	22	25		dB
		2.0 to 3.0 GHz, 25°C	20	23		dB
Isolation (ETC) (Note 4)	ISO	0.7 to 1.0 GHz, -40°C to 105 °C	22	24		dB
		1.0 to 2.0 GHz, -40°C to 105 °C	22	23.5		dB
		2.0 to 3.0 GHz, -40°C to 105 °C	20	23		dB
Voltage standing wave ratio	VSWR	0.7 to 1.0 GHz, 25°C		1.2:1	1.4:1	
		1.0 to 2.0 GHz, 25°C		1.2:1	1.4:1	
		2.0 to 3.0 GHz, 25°C		1.3:1	1.45:1	
Voltage standing wave ratio (ETC) (Note 4)	VSWR	0.7 to 1.0 GHz, -40°C to 105 °C		1.2:1	1.4:1	
		1.0 to 2.0 GHz, -40°C to 105 °C		1.2:1	1.4:1	
		2.0 to 3.0 GHz, -40°C to 105 °C		1.3:1	1.45:1	
Switching characteristics: Rise/fall On/off Video feedthrough	T _{SW}	10/90% or 90/10% RF, 25°C		90	180	ns
	T _{ON}	50% control to 90/10% RF, 25°C		125	250	ns
		bandwidth = 500 MHz, 25°C		25		mV
Switching characteristics (ETC) (Note 4): Rise/fall (ETC) On/off (ETC)	T _{SW}	10/90% or 90/10% RF, -40°C to 105 °C		90	180	ns
	T _{ON}	50% control to 90/10% RF, -40°C to 105 °C		150	250	ns
1 dB input compression point	IP1dB	0.7 to 3.0 GHz:				
		$V_{CTL} = 0$ to 2 V, 25°C	+23	+25		dBm
		$V_{CTL} = 0$ to 3 V, 25°C	+28	+30		dBm
1 dB input compression point (ETC) (Note 4)	IP1dB	0.7 to 3.0 GHz:				
		$V_{CTL} = 0$ to 2 V, 25°C	+18	+20		dBm
		$V_{CTL} = 0$ to 3 V, 25°C	+23	+26		dBm
Third order intercept point	IP3	+5 dBm two-tone input power @ 0.7 to 3.0 GHz:				
		$V_{CTL} = 0$ to 2 V, 25°C	+36	+49		dBm
		$V_{CTL} = 0$ to 3 V, 25°C	+42	+52		dBm
Third order intercept point (ETC) (Note 4)	IP3	$V_{CTL} = 0$ to 2 V, -40°C to 105 °C	+35	+49		dBm
		$V_{CTL} = 0$ to 3 V, -40°C to 105 °C	+39	+50		dBm
		$V_{CTL} = 0$ to 5 V, -40°C to 105 °C	+41	+51		dBm
Control voltage: Low (@ 20 μ A max) High (@100 μ A max) High (@ 200 μ A max)	V_{CTL_L}		0		0.2	V
	V_{CTL_H}				2.0	V
	V_{CTL_H}				5.0	V

Note 1: Performance is guaranteed only under the conditions listed in this table.

Note 2: Insertion loss changes by 0.003 dB/°C.

Note 3: Insertion loss state.

Note 4: ETC = Extreme Test Conditions ($V_{CTL} = 0$ to 5 V, $T_{OP} = -40$ °C to +105 °C).

Typical Performance Characteristics

($V_{CTL} = 0$ to 3 V, $T_{OP} = +25$ °C, $P_{IN} = 0$ dBm, Characteristic Impedance [Z_0] = 50Ω , $C_{BL} = 100$ pF, Unless Otherwise Noted)

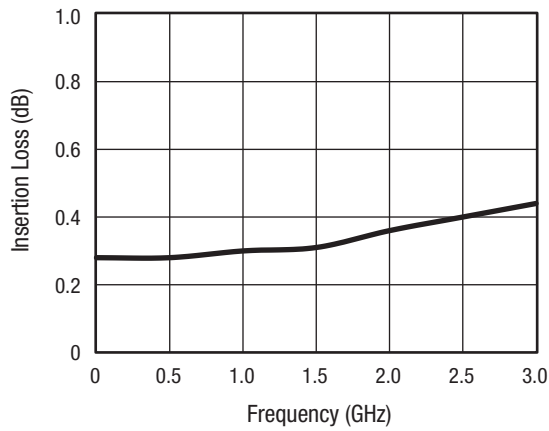

Figure 2. Insertion Loss vs Frequency

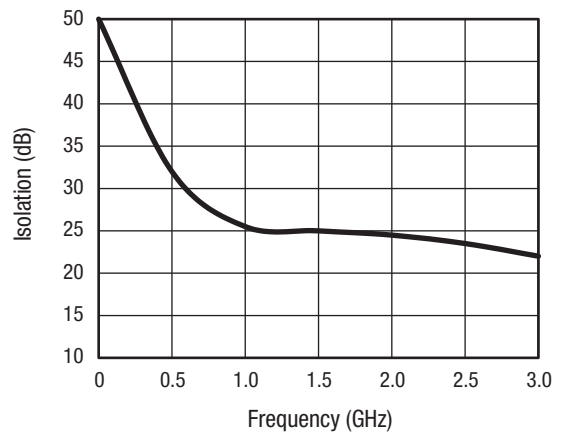

Figure 3. Isolation vs Frequency

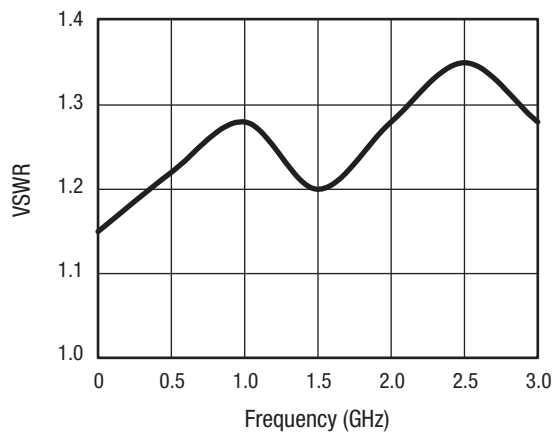

Figure 4. VSWR vs Frequency

Table 4. Truth Table ($V_{HIGH} = 2.0$ to 5.0 V, $V_{LOW} = -0.2$ to $+0.2$ V) (Note 1)

V1	V2	J1-J2	J1-J3
V_{HIGH}	V_{LOW}	Isolation	Insertion loss
V_{LOW}	V_{HIGH}	Insertion loss	Isolation

Note 1: Any state other than described in this table places the device in an undefined state. An undefined state does not damage the device.

Evaluation Board Description

The SKYA21001 Evaluation Board is used to test the performance of the SKYA21001 SPDT switch. An Evaluation Board schematic diagram is provided in Figure 5. An assembly drawing for the Evaluation Board is shown in Figure 6.

Package Dimensions

Package dimensions for the 6-pin SC-70 are shown in Figure 7, and tape and reel dimensions are provided in Figure 8.

Package and Handling Information

Instructions on the shipping container label regarding exposure to moisture after the container seal is broken must be followed. Otherwise, problems related to moisture absorption may occur when the part is subjected to high temperature during solder assembly.

The SKYA21001 is rated to Moisture Sensitivity Level 1 (MSL1) at 260 °C. It can be used for lead or lead-free soldering.

Care must be taken when attaching this product, whether it is done manually or in a production solder reflow environment. Production quantities of this product are shipped in a standard tape and reel format.

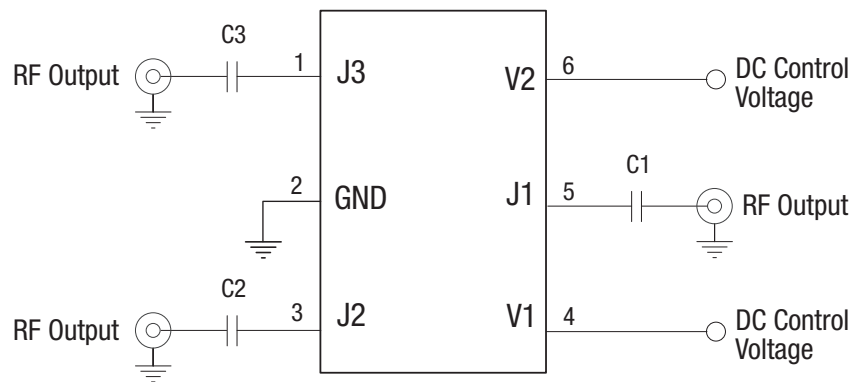

Note: Use 100 pF blocking capacitors (C1, C2, C3) for >500 MHz operation. Higher values recommended for lower frequency operation. Exposed paddle must be grounded.
Use 10 nF blocking capacitors (C1, C2, C3) for <50 MHz operation.

S2108

Figure 5. SKYA21001 Evaluation Board Schematic

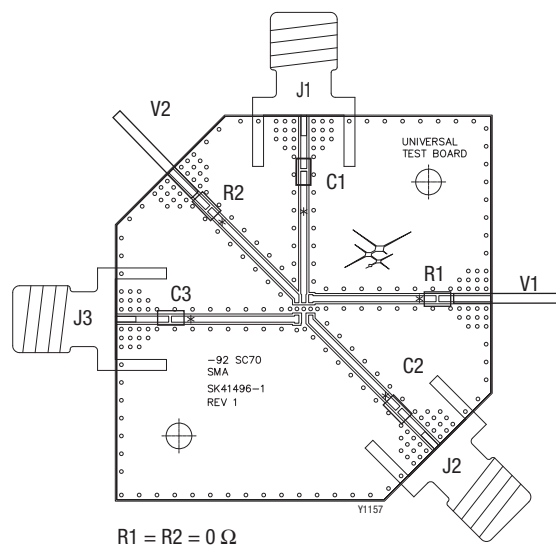

Figure 6. SKYA21001 Evaluation Board Assembly Diagram

Ordering Information

Model Name	Manufacturing Part Number	Evaluation Board Part Number
SKYA21001: SPDT Switch	SKYA21001	SKYA21001-EVB

Copyright © 2013-2015 Skyworks Solutions, Inc. All Rights Reserved.

Information in this document is provided in connection with Skyworks Solutions, Inc. ("Skyworks") products or services. These materials, including the information contained herein, are provided by Skyworks as a service to its customers and may be used for informational purposes only by the customer. Skyworks assumes no responsibility for errors or omissions in these materials or the information contained herein. Skyworks may change its documentation, products, services, specifications or product descriptions at any time, without notice. Skyworks makes no commitment to update the materials or information and shall have no responsibility whatsoever for conflicts, incompatibilities, or other difficulties arising from any future changes.

No license, whether express, implied, by estoppel or otherwise, is granted to any intellectual property rights by this document. Skyworks assumes no liability for any materials, products or information provided hereunder, including the sale, distribution, reproduction or use of Skyworks products, information or materials, except as may be provided in Skyworks Terms and Conditions of Sale.

THE MATERIALS, PRODUCTS AND INFORMATION ARE PROVIDED "AS IS" WITHOUT WARRANTY OF ANY KIND, WHETHER EXPRESS, IMPLIED, STATUTORY, OR OTHERWISE, INCLUDING FITNESS FOR A PARTICULAR PURPOSE OR USE, MERCHANTABILITY, PERFORMANCE, QUALITY OR NON-INFRINGEMENT OF ANY INTELLECTUAL PROPERTY RIGHT; ALL SUCH WARRANTIES ARE HEREBY EXPRESSLY DISCLAIMED. SKYWORKS DOES NOT WARRANT THE ACCURACY OR COMPLETENESS OF THE INFORMATION, TEXT, GRAPHICS OR OTHER ITEMS CONTAINED WITHIN THESE MATERIALS. SKYWORKS SHALL NOT BE LIABLE FOR ANY DAMAGES, INCLUDING BUT NOT LIMITED TO ANY SPECIAL, INDIRECT, INCIDENTAL, STATUTORY, OR CONSEQUENTIAL DAMAGES, INCLUDING WITHOUT LIMITATION, LOST REVENUES OR LOST PROFITS THAT MAY RESULT FROM THE USE OF THE MATERIALS OR INFORMATION, WHETHER OR NOT THE RECIPIENT OF MATERIALS HAS BEEN ADVISED OF THE POSSIBILITY OF SUCH DAMAGE.

Skyworks products are not intended for use in medical, lifesaving or life-sustaining applications, or other equipment in which the failure of the Skyworks products could lead to personal injury, death, physical or environmental damage. Skyworks customers using or selling Skyworks products for use in such applications do so at their own risk and agree to fully indemnify Skyworks for any damages resulting from such improper use or sale.

Customers are responsible for their products and applications using Skyworks products, which may deviate from published specifications as a result of design defects, errors, or operation of products outside of published parameters or design specifications. Customers should include design and operating safeguards to minimize these and other risks. Skyworks assumes no liability for applications assistance, customer product design, or damage to any equipment resulting from the use of Skyworks products outside of stated published specifications or parameters.

Skyworks and the Skyworks symbol are trademarks or registered trademarks of Skyworks Solutions, Inc., in the United States and other countries. Third-party brands and names are for identification purposes only, and are the property of their respective owners. Additional information, including relevant terms and conditions, posted at www.skyworksinc.com, are incorporated by reference.