

GL Series: Single & Multi Output Switchers

The new GL series provides a broad range of AC/DC power supply solutions that covers power ratings from 25 watts to 250 watts for use in various industrial applications requiring standard footprint size and very high reliability.

These low-profile AC/DC switchers offer universal input voltage with no switches or jumpers, ideal for higher volume worldwide applications.

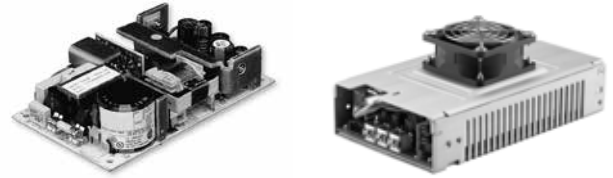

All models feature:

- Industry standard footprints
- Universal input
- Full power to 50°C
- High demonstrated MTBF
- Automatic overvoltage protection
- Overload protection
- Built-in EMI Filtering
- Extensive safety approvals
- Derated operation to 70°C
- ±2% regulation on main output
- 250 VA size enclosed
- Two year limited warranty

Many models feature:

- EN61000-3-2 Compliance
- Supervisory outputs (5 V/12 V)
- Wide-adjustable floating 4th output
- Single wire current share
- Remote Sense
- Adjustable main output
- Power Fail and DC Good signals
- Wide-adjustable on single output models

Certifications and Compliances

- Recognized Component, ITE
 - UL 60950-1
- Certified, ITE
 - CSA C22.2 CSA 60950-1
- - IEC60950-1

Cover Options

- Cover options can be ordered separately. They are designed to simplify mechanical integration of the power supplies into systems and add an extra measure of electrical safety for service personnel.

Cover and Bracket Options	
Catalog Number	Description
GLX40	Enclosure kit for the GL20 and GL40
GLX250-CEF	Cover end fan kit for the GL250
GLX250-CF	Cover with top fan kit for the GL250/350

Specifications

	GL20, GL40	GL50	GL60	GL250
Input				
Input Voltage ¹	85 - 264 Vac; 120 - 300 Vdc	90 - 264 Vac 127 - 300 Vdc	85 - 264 Vac 120 - 300 Vdc	85 - 264 Vac; 120 - 300 Vdc
Frequency	47-63 Hz , 400± 40 Hz		47-63 Hz	
Inrush Current	GL20: <15A peak @ 115 Vac; <30A peak @ 230 Vac, cold start @ 25°C. GL40: <18A peak @ 115 Vac; <36A peak @ 230 Vac, cold start @ 25°C	<60A peak @ 230 Vac, cold start @ 25°C	<18A peak @ 115 Vac, <36 A peak @ 230 Vac, cold start @ 25°C	GL250: 20 A max., cold start @ 25°C.
Efficiency	70% typical at full load	80% - 85% typical at full load	70% typical at full load	75% typical at full load
EMI/RFI	FCC Class B ; CISPR 22 Class B ; EN55022 Class B			
Output				
Power	Refer to the selection table			
Adjustment Range on Main Output	-5, +10% minimum	±20% minimum for single output only models	-5, +10% minimum	2:1 wide ratio
Hold-up Time	20 ms @ full load, 115 Vac nominal line	10/20 ms 115/230 Vac Input line	20 ms @ full load, 115 Vac nominal line	20 ms @ full load, 115 Vac nominal line
Overload	Short circuit protection on all outputs. Primary overload protection			
Overvoltage Protection	5 V output; 5.7 to 6.7 Vdc. Other outputs 10% to 25% above nominal output	30-50% above nominal output	5 V output; 5.7 - 6.7 Vdc. Other outputs 10% to 25% above nominal output	5 V output: 5.7 to 6.7 Vdc. Other outputs 10% to 25% above nominal output
Remote Sense	Compensates for 0.5 V lead drop minimum; Will operate without remote sense connected, Reverse connection protected			
General				
Temperature ²	Storage: -40°C to +85°C; Operating: 0° to 50°C ambient. Derate each output 2.5% per degree from 50° to 70°C, -20°C start up.			
Electro-magnetic Susceptibility	Designed to meet IEC 801, -2, -3, -4, -5, -6, Level 3 or EN61000-4; -2, -3, -4, -5, -6, -8, -11 Level 3			
Humidity	Operating: non-condensing up to 95% RH			
Vibration	Three orthogonal axes, sweep at 1 oct/min, 5 min. dwell at four major resonances 0.75G peak 5Hz to 500 Hz (2 G peak 8 Hz to 500 Hz for GL500)			
MTBF	>550,000 hours demonstrated at full load and 25°C ambient conditions			
Safety	EN60950, cRUus: UL/CSA 60950 E132002, CE Mark (LVD)			

Notes:

1. Proper circuit protection required when operating with a DC input voltage. 2. Regulation and ripple may deviate from the spec at -20°C start up.

Selection Table

	Catalog Number	Output 1	Output 2	Output 3	Output 4	Case ³	Pin Assignments ³	Mating Connectors ³
GL20 [40 W] 25 W	GLS22	5 V @ 5 A [8 A] ⁴	-	-	-	1	1A	1B
	GLT22	5 V @ 3 A [4 A] ⁵	12 V @ 1.5 A [2 A] ⁵	-12 V @ 0.5 A [0.7 A]	-		2A	
GL40 [55 W] 40 W ¹ [40 W] 25 W ²	GLS42 ⁴	5 V @ 8 A [11 A] ⁴	-	-	-	1	3A	1B
	GLS43 ⁴	12 V @ 3.3 A [4.5] ⁴	-	-	-		4A	
	GLT42 ⁴	5 V @ 4 A [5 A] ⁵	12 V @ 2 A [2.5 A] ⁵	-12 V @ 0.5 A [0.7 A]	-			
	GLT45 ⁴	5 V @ 4 A [5 A] ⁵	15 V @ 2 A [2.5 A] ⁵	-15 V @ 0.5 A [0.7 A]	-			
GL50 [50 W] 50 W	GLT54 ⁴	5 V @ 8 A ⁵	24 V @ 1.5 A ⁵	12 V @ 0.5 A	-	2	5A	2B
GL50 [60 W] 60 W	GLS55 ⁴	24 V @ 2.5 A ⁴	-	-	-	3	6A	2B
GL60 [80 W] 60 W ¹ [60 W] 40 W ²	GLS63 ⁴	12 V @ 5 A [6.7 A] ⁴	-	-	-	4	7A	3B
	GLS64 ⁴	15 V @ 4 A [5.3 A] ⁴	-	-	-			
GL250 [250 W] ^{6 7}	GLS253-C	12 V (6-12 V) @ [21 A]	-	-	-	5	8A	4B
	GLS255-C	24 V (24-48) @ [10.4 A]	-	-	-			
	GLQ252-C	5 V @ [35 A] ⁷	12 V @ [10 A]	-12 V @ [6 A]	±5-25 V @ [6 A] ⁴	6	9A	
	GLQ253-C	5 V @ [35 A] ⁷	15 V @ [10 A]	-15 V @ [6A]	±5-25 V @ [6 A] ⁴			

Notes:

[] Rating with 30 CFM of air

1. Power rating when no cover option is used
2. Power rating when the cover/enclosure option is used
3. Refer to GL Series Dimensions and the sections that follow

4. Floating output
5. Approximate minimum loading: 10%
6. Optional fan cover, See Table 1
7. Optional end fan cover, See Table 1

GL Series Dimensions

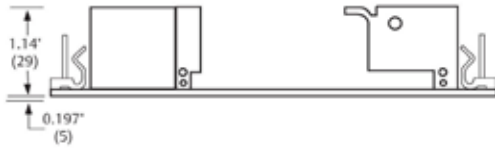
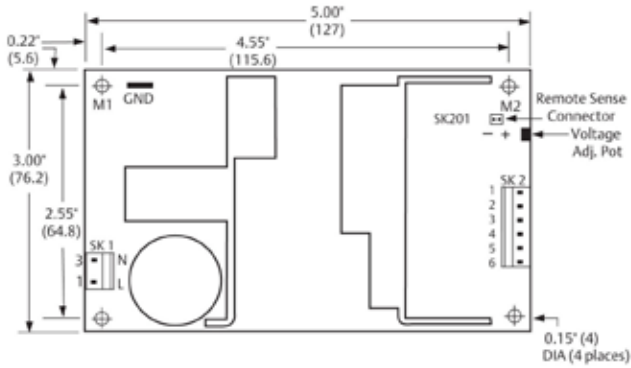

Case 1
(Weight: 0.5 lbs/0.23 kg approx.)

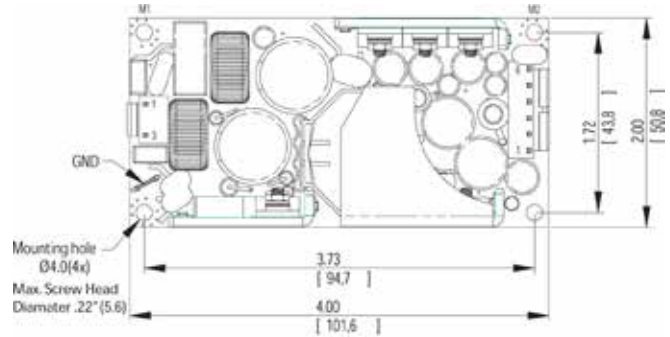

Case 2
(Weight: 0.45 lbs/0.20 kg approx.)

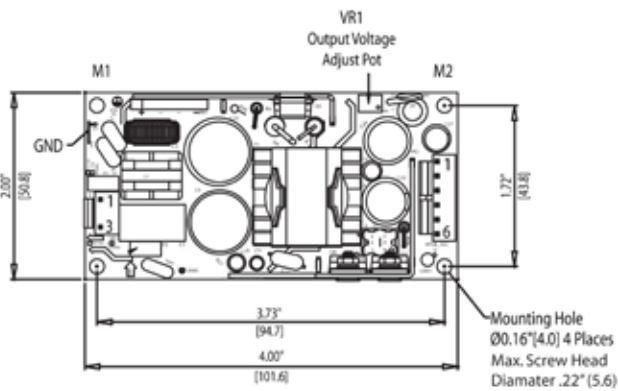

Case 3
(Weight: 0.41 lbs/0.18 kg approx.)

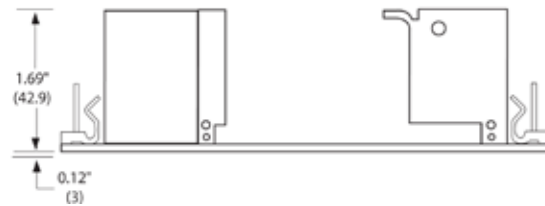
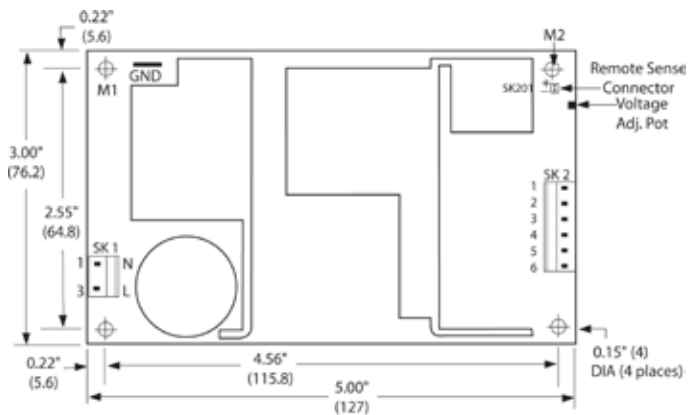

Case 4
(Weight: 0.75 lbs/0.34 kg approx.)

Notes:

1. Specifications subject to change without notice.
2. All dimensions in inches (mm), tolerance is ± 0.02 " (± 0.5 mm)
3. Mounting holes M1 and M2 should be grounded for EMI purposes.
4. Mounting hole M1 is safety ground connection.
5. Specifications are for convection rating at factory settings at 115 Vac input, 25°C unless otherwise stated.

GL Series Dimensions (continued)

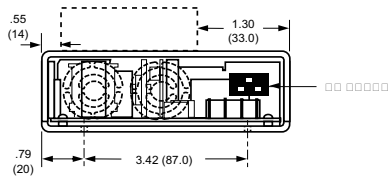
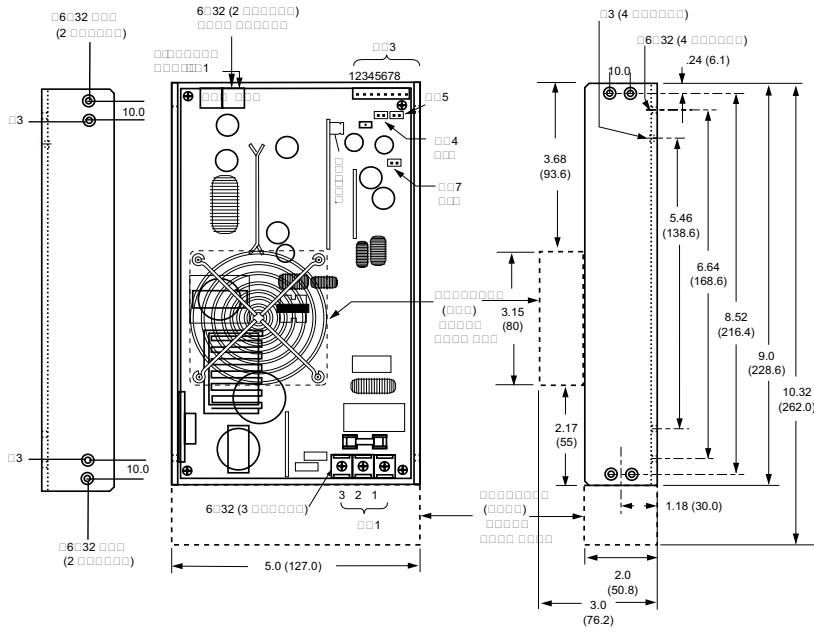

Case 5
(Weight: 2.6 lbs/1.19 kg approx.)

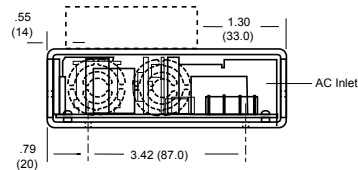
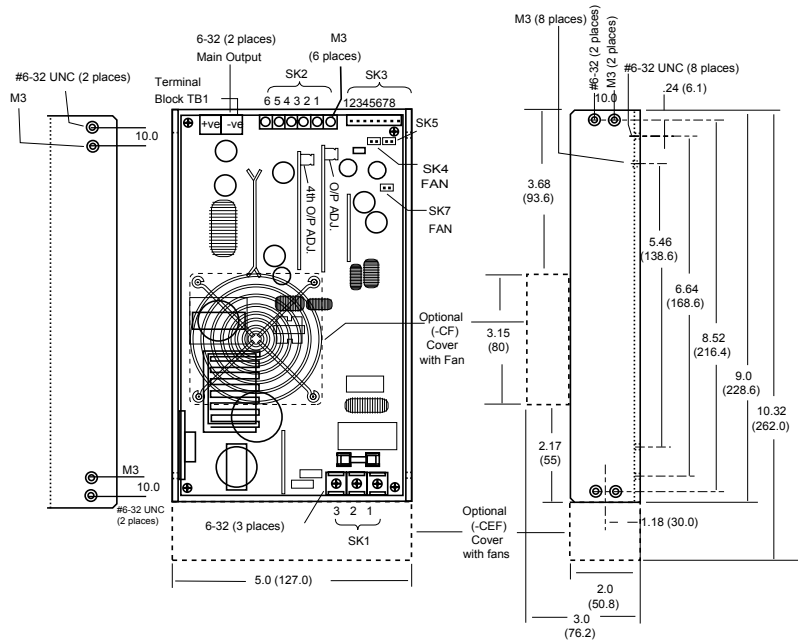

Case 6
(Weight: 3.1 lbs/1.41 kg approx.)

Notes:

1. Specifications subject to change without notice.
2. All dimensions in inches (mm), tolerance is $\pm 0.02"$.
3. Specifications are at factory settings.
4. To enable normally closed remote inhibit, cut jumper J1.
5. Mounting maximum insertion depth is 0.12".

GL Series Pin Assignments

1A

Connector		GLS22
SK1	PIN 1	Line
	PIN 3	Neutral
SK2	PIN 1	+5 V
	PIN 2	+5 V
	PIN 3	+5 V
	PIN 4	Common
	PIN 5	Common
	PIN 6	Common
SK201	PIN 1	+Sense
	PIN 2	-Sense

5A

Connector		GLT54
SK1	PIN 1	Neutral
	PIN 3	Line
SK2	PIN 1	+5 V
	PIN 2	+5 V
	PIN 3	Common
	PIN 4	Common
	PIN 5	+12 V
	PIN 6	+24 V

2A

Connector		GLT22
SK1	PIN 1	Line
	PIN 3	Neutral
SK2	PIN 1	+12 V
	PIN 2	+5 V
	PIN 3	+5 V
	PIN 4	Common
	PIN 5	Common
	PIN 6	-12 V
SK201	PIN 1	+Sense
	PIN 2	-Sense

6A

Connector		GLS55
SK1	PIN 1	Line
	PIN 3	Neutral
SK2	PIN 1	+24 V
	PIN 2	+24 V
	PIN 3	Common
	PIN 4	Common
	PIN 5	-Sense
	PIN 6	+Sense

3A

Connector		GLS42	GLS43
SK1	PIN 1	Line	
	PIN 3	Neutral	
SK2	PIN 1	+5 V	+12 V
	PIN 2	+5 V	+12 V
	PIN 3	+5 V	+12 V
	PIN 4	Common	
	PIN 5	Common	
	PIN 6	Common	
SK201	PIN 1	+Sense	
	PIN 2	-Sense	

7A

Connector		GLS63	GLS64
SK1	PIN 1	Neutral	
	PIN 3	Line	
SK2	PIN 1	+12 V	+15 V
	PIN 2	+12 V	+15 V
	PIN 3	+12 V	+15 V
	PIN 4	Common	
	PIN 5	Common	
	PIN 6	Common	
SK201	PIN 1	+Sense	
	PIN 2	-Sense	

4A

Connector		GLT42
SK1	PIN 1	Line
	PIN 3	Neutral
SK2	PIN 1	+12 V
	PIN 2	+5 V
	PIN 3	+5 V
	PIN 4	Common
	PIN 5	Common
	PIN 6	-12 V
SK201	PIN 1	+Sense
	PIN 2	-Sense

GL Series Pin Assignments (continued)

8A

Connector		GLS250
SK1	PIN 1	Neutral
	PIN 2	Line
	PIN 3	Ground
SK3	PIN 1	+Remote Sense
	PIN 2	-Remote Sense
	PIN 3	Remote Inhibit (N.O)
	PIN 4	Remote Inhibit (N.C)
	PIN 5	Common
	PIN 6	Current Share
	PIN 7	Power Fail
	PIN 8	DC Power Good
SK4	PIN 1	+Fan's power source (12 V @ 500 mA)
	PIN 2	-Fan's power source (12 V @ 500 mA)
SK5	PIN 1	+Supervisory output supply (5 V @ 100 mA)
	PIN 2	-Supervisory output supply (5 V @ 100 mA)
SK7	PIN 1	+Fan's power source (12 V @ 500 mA)
	PIN 2	+Fan's power source (12 V @ 500 mA)

9A

Connector		GLQ250
SK1	PIN 1	Neutral
	PIN 2	Line
	PIN 3	Ground
SK2	PIN 1	+12 / 15 V
	PIN 2	Common
	PIN 3	Common
	PIN 4	-12 / 15 V
	PIN 5	5-25 V RET Float
	PIN 6	5-25 V Float
SK3	PIN 1	+Remote Sense
	PIN 2	-Remote Sense
	PIN 3	Remote Inhibit (N.O.)
	PIN 4	Remote Inhibit (N.C.)
	PIN 5	Common
	PIN 6	Current Share
	PIN 7	Power Fail
	PIN 8	DC Power Good
SK4	PIN 1	+Fan's power source (12 V @ 500 mA)
	PIN 2	+Fan's power source (12 V @ 500 mA)
SK5	PIN 1	+Supervisory output supply (5 V @ 100 mA)
	PIN 2	-Supervisory output supply (5 V @ 100 mA)
SK7	PIN 1	+Fan's power source (12 V @ 500 mA)
	PIN 2	+Fan's power source (12 V @ 500 mA)

GL Series Mating Connectors

1B

Connector Kit #70-841-006 includes the following:	
AC Input:	Molex 09-50-8031 (USA) Not required for (-T) option 09-91-0300 (UK) PINS: 08-52-0113 (-0111 for medical)
DC Outputs:	Molex 09-50-8061 (USA) Not required for (-T) option 09-91-0600 (UK) PINS: 08-52-0113 (-0111 for medical)
Remote Sense:	Molex 22-01-2025 PINS: 08-52-0123 (-0114 for medical)

2B

Connector Kit #70-841-006 includes the following:	
AC Input:	Molex 09-50-8031 (USA) 09-91-0300 (UK) PINS: 08-52-0113
DC Outputs:	Molex 09-50-8061 (USA) 09-91-0600 (UK) PINS: 08-52-0113

3B

Connector Kit #70-841-006 includes the following:	
AC Input:	Molex 09-50-8031 (USA) Not required for (-T) option 09-91-0300 (UK) PINS: 08-58-0111 (-0113 for medical)
DC Outputs:	Molex 09-50-8061 (USA) Not required for (-T) option 09-91-0600 (UK) PINS: 08-58-0113
Remote Sense:	Molex 22-01-2025 PINS: 08-52-0113

4B

Connector Kit #70-841-005 includes the following:	
SK3	Molex 22-01-1084; PINS: 08-70-0057
SK4	Molex 22-01-3027; PINS: 08-50-0114
SK5	Molex 22-01-3027; PINS:08-50-0114
SK7	Molex: 22-01-3027 PINS: 08-50-0114