

STFV Plus Series – Active Tracking® Filtering with Surge Protection

The SolaHD STFV Plus Series combines Active Tracking® filtration for low energy noise and surge protection for high energy transients. It continuously tracks the input AC power line responding instantly into action upon detecting extraneous high frequency noise and high voltage transients caused by everyday events such as turning on machinery, motors, or equipment.

These devices are designed to meet UL 1283 for Electromagnetic Interference Filters. STFV Plus attenuates or reduces the amplitude of high frequency noise to a maximum of 90dB that occurs in a range of 100 kHz to 50 MHz. STFV Plus provides the industry's best IEEE C62.41 Category "A & B" Ringwave protection.

They are built to meet your unique requirements, and are available in hardwired, single phase configuration. They are designed for years of trouble free operation and require little or no operator intervention after installation.

Active Tracking® Filters Plus is one part of a total power quality solution. They can be used alone or in conjunction with other SolaHD products to solve more complex power quality problems.

Applications

- Branch and Control Panels
- Factory Automation Installations
- Point of Use Industrial Service Equipment
- Programmable Logic Controllers
- Dedicated Industrial and Machine Tools
- Telecommunications and IT Equipment

Features

- Non degrading, series filter/TVSS technology for total durability
- UL surge current capacity – 25,000 amps
- High impact plastic case, epoxy encapsulated enclosure
- Transient protection in all modes (L-N, L-G, and N-G)
- Single phase applications up to 30 amp
- Operating temperature from -40°C to +60°C
- Hardwired connection
- LED power indication
- Ten year limited warranty



Certifications and Compliances

- Certified
 - CSA C22.2 No. 8
- UL Recognized Component
 - UL 1283
- RoHS Compliant

Related Products

- Power Conditioners
- Uninterruptible Power Supplies
- Power Supplies

Selection Table

Catalog Number	Amps	Case Dim. in (mm) – A x B x C	Mounting Flange Dim. in (mm) – D x E x F x G	Number Min. Wire Size (AWG Suggested)	Screw Size	Fuse/Circuit Breaker Ampacity		Weight lbs (kg)
						Suggest	Max	
Single-Phase Models (120 Vac)								
STFV025-10N	2.5	4.00 x 2.88 x 1.81 (101.6 x 73.2 x 46.0)	4.38 x 2.12 x 5.31 x 0.19 (111.3 x 53.8 x 134.9 x 4.8)	26	#6	2.5	3.125	1.0 (.45)
STFV050-10N	5.0	4.00 x 2.88 x 1.81 (101.6 x 73.2 x 46.0)	4.38 x 2.12 x 5.31 x 0.19 (111.3 x 53.8 x 134.9 x 4.8)	22	#6	5	6.25	1.3 (.59)
STFV075-10N	7.5	4.75 x 4.75 x 2.35 (120.7 x 120.7 x 59.7)	5.25 x 3.50 x 6.25 x 0.19 (133.4 x 88.9 x 158.8 x 4.8)	18	#6	7.5	6.25	2.0 (.91)
STFV150-10N	15.0	6.25 x 4.75 x 2.35 (158.8 x 120.7 x 59.7)	6.75 x 3.50 x 7.75 x 0.19 (171.5 x 88.9 x 196.9 x 4.8)	14	#8	15	18.75	3.5 (1.59)
STFV300-10N	30.0	7.75 x 4.75 x 2.35 (196.9 x 120.7 x 59.7)	8.25 x 3.50 x 9.00 x 0.19 (209.6 x 88.9 x 228.6 x 4.8)	10	#8	30	37.5	6.0 (2.72)
Single-Phase Models (240 Vac)								
STFV025-24L	2.5	4.00 x 2.88 x 1.81 (101.6 x 73.2 x 46.0)	4.38 x 2.12 x 5.31 x 0.19 (111.3 x 53.8 x 134.9 x 4.8)	26	#6	2.5	3.125	1.3 (.59)
STFV050-24L	5.0	4.75 x 4.75 x 2.35 (120.7 x 120.7 x 59.7)	5.25 x 3.50 x 6.25 x 0.19 (133.4 x 88.9 x 158.8 x 4.8)	22	#6	5	6.25	2.0 (.91)
STFV075-24L	7.5	6.25 x 4.75 x 2.35 (158.8 x 120.7 x 59.7)	6.75 x 3.50 x 7.75 x 0.19 (171.5 x 88.9 x 196.9 x 4.8)	18	#6	7.5	9.375	3.5 (1.59)
STFV150-24L	15.0	7.75 x 4.75 x 2.35 (196.9 x 120.7 x 59.7)	8.25 x 3.50 x 9.00 x 0.19 (209.6 x 88.9 x 228.6 x 4.8)	14	#8	15	18.75	5.8 (2.63)
STFV300-24L	30.0	7.75 x 4.75 x 2.35 (196.9 x 120.7 x 59.7)	8.25 x 3.50 x 9.00 x 0.19 (209.6 x 88.9 x 228.6 x 4.8)	10	#8	30	37.5	6.0 (2.72)

Dimensional Diagram

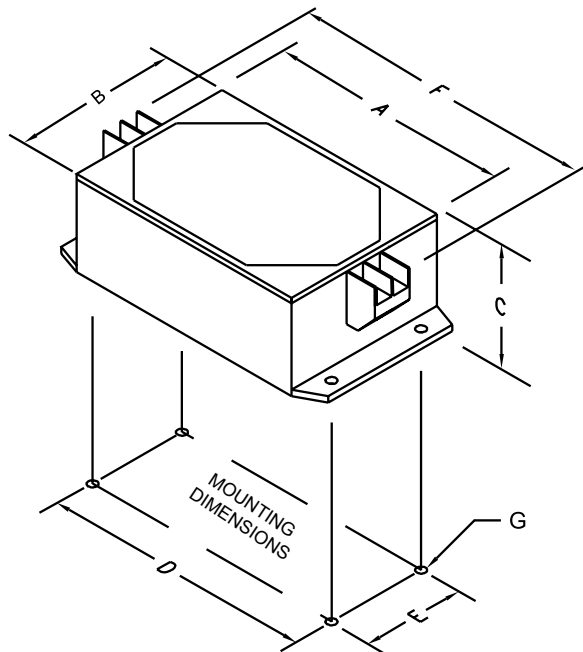

System Design

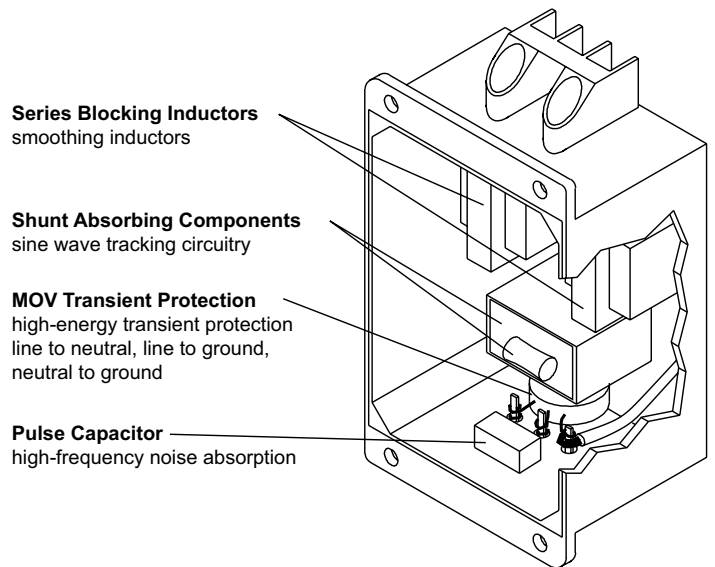

STFV Specifications

Description	Value	
Input Voltage	120 Vac Models	0-150 Vrms
	240 Vac Models	0-275 Vrms
Line Frequency	50/60 Hz	
Configuration	Single Phase (2 wire + ground)	
Response Time	< 5 ns	
Enclosure	High impact plastic case, 94V-0, Vacuum impregnated magnetics, epoxy encapsulated	
Fusing	External	
Status Indication	Green LED	
Connection/Mounting Type	Series/Panel Mount	
Operating Temperature	-40°C to +60°C at full load Derate Linearly to 60% at +70°C	
Operating Humidity	0% to 95% Non-condensing	
Mean Time Between Failure (MTBF)	Greater than 100,000 hours (Mil. Std. 217F)	
Packaging	High impact plastic case, vacuum impregnated magnetics, epoxy encapsulated	
Peak Surge Current Capability (8 x 20 μs)	Per Phase	25,000 Amps
	Line to Neutral	12,500 Amps
	Line to Ground	12,500 Amps
	Neutral to Ground	12,500 Amps
Load Surge Current Rating	10m sec	5 x Nominal
	1 sec	3 x Nominal
	10 sec	2 x Nominal
Frequency Response (Forward Reverse)	100 kHz to 50 MHz	90 dB Max
Transient Reduction * (IEEE C62.41)	Typical Category A Ringwave (6 kV, 200A, 100 kHz)	< 10 volts peak
	Typical Category B Ringwave (6 kV, 500A, 100 kHz)	< 50 volts peak
Warranty	10 year limited warranty	

* All measurements in volts. IEEE test results with no AC applied.