

SMD Power Inductor CDR6D23MN



Description

- Ferrite drum core construction.
- Magnetically shielded.
- L × W × H: 6.8 × 6.8 × 2.5 mm Max.
- Product weight: 0.27g(Ref.)
- Moisture Sensitivity Level: 1
- RoHS compliance.

Environmental Data

- Operating temperature range: -40°C ~ +105°C (including coil's self temperature rise)
- Storage temperature range: -40°C ~ +105°C
- Solder reflow temperature: 260 °C peak.

Packaging

- Carrier tape and reel packaging
- 11.8" diameter reel
- 1500pcs per reel

Applications

- Ideally used in LCD driver, DSC/DVC , Notebook PC or the other portable equipment

Dimension - [mm]

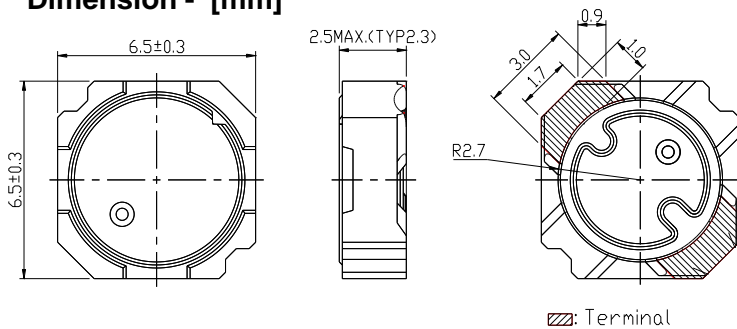

Land pattern and Schematics - [mm]

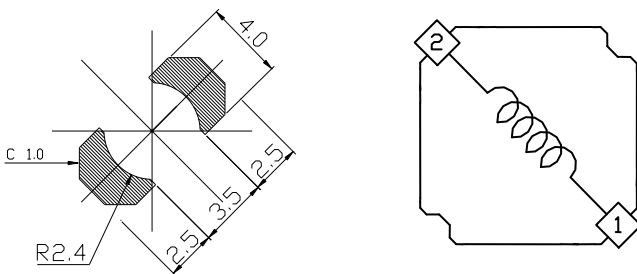



Electrical Characteristics

Part Name	Stamp	Inductance (μH) [Within] ※1	D.C.R. (m Ω) Max. (Typ.) (at 20°C)	Saturation Current (A) ※2		Temperature Rise Current (A)※3
				(at 20°C)	(at 105°C)	
CDR6D23MNNP-0R6NC	0R6	0.6 $\mu\text{H} \pm 25\%$	20.0(16)	6.55	4.95	4.60
CDR6D23MNNP-1R0NC	1R0	1.0 $\mu\text{H} \pm 25\%$	25.0(20)	5.15	4.00	3.90
CDR6D23MNNP-1R5NC	1R5	1.5 $\mu\text{H} \pm 25\%$	28.0(22)	4.40	3.55	3.30
CDR6D23MNNP-2R0NC	2R0	2.0 $\mu\text{H} \pm 25\%$	36.3(29)	3.85	3.05	2.60
CDR6D23MNNP-2R7NC	2R7	2.7 $\mu\text{H} \pm 25\%$	40.0(32)	3.30	2.60	2.38
CDR6D23MNNP-3R3NC	3R3	3.3 $\mu\text{H} \pm 25\%$	46.3(37)	2.95	2.30	2.25
CDR6D23MNNP-4R2NC	4R2	4.2 $\mu\text{H} \pm 25\%$	52.5(42)	2.60	2.10	2.05
CDR6D23MNNP-5R1NC	5R1	5.1 $\mu\text{H} \pm 25\%$	60.0(48)	2.45	1.95	1.90
CDR6D23MNNP-6R1NC	6R1	6.1 $\mu\text{H} \pm 25\%$	66.3(53)	2.30	1.75	1.80
CDR6D23MNNP-7R2NC	7R2	7.2 $\mu\text{H} \pm 25\%$	72.5(58)	2.10	1.60	1.70
CDR6D23MNNP-8R3NC	8R3	8.3 $\mu\text{H} \pm 25\%$	80.0(64)	1.95	1.50	1.50
CDR6D23MNNP-100NC	100	10 $\mu\text{H} \pm 25\%$	103.8(83)	1.75	1.40	1.30
CDR6D23MNNP-120NC	120	12 $\mu\text{H} \pm 25\%$	117.5(94)	1.55	1.25	1.25
CDR6D23MNNP-150NC	150	15 $\mu\text{H} \pm 25\%$	133.8(107)	1.40	1.15	1.10
CDR6D23MNNP-180NC	180	18 $\mu\text{H} \pm 25\%$	158.8(127)	1.30	1.05	1.00
CDR6D23MNNP-220NC	220	22 $\mu\text{H} \pm 25\%$	187.5(150)	1.20	0.95	0.80
CDR6D23MNNP-270NC	270	27 $\mu\text{H} \pm 25\%$	255.0(204)	1.05	0.85	0.75
CDR6D23MNNP-330NC	330	33 $\mu\text{H} \pm 25\%$	275.0(220)	0.95	0.75	0.70
CDR6D23MNNP-390NC	390	39 $\mu\text{H} \pm 25\%$	393.8(315)	0.90	0.70	0.58
CDR6D23MNNP-470NC	470	47 $\mu\text{H} \pm 25\%$	456.3(365)	0.80	0.60	0.54
CDR6D23MNNP-560NC	560	56 $\mu\text{H} \pm 25\%$	481.2(385)	0.75	0.58	0.51
CDR6D23MNNP-680NC	680	68 $\mu\text{H} \pm 25\%$	751.3(601)	0.65	0.53	0.45
CDR6D23MNNP-820NC	820	82 $\mu\text{H} \pm 25\%$	803.8(643)	0.60	0.47	0.43
CDR6D23MNNP-101NC	101	100 $\mu\text{H} \pm 25\%$	903.8(723)	0.55	0.44	0.41

※1. Inductance measuring condition: at 100kHz.

※2. Saturation current: The value of D.C. current when the inductance decreases to 65% of its nominal value.

※3. Temperature rise current: The value of D.C. current when the temperature rise is $\Delta t = 40^\circ\text{C}$ ($T_a = 20^\circ\text{C}$).

SMD Power Inductor CDR6D23MN



Saturation Current & Temperature Rise Graph

— L (20°C) — L (105°C) — ΔT

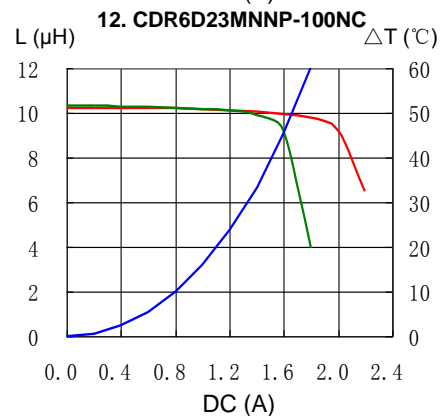
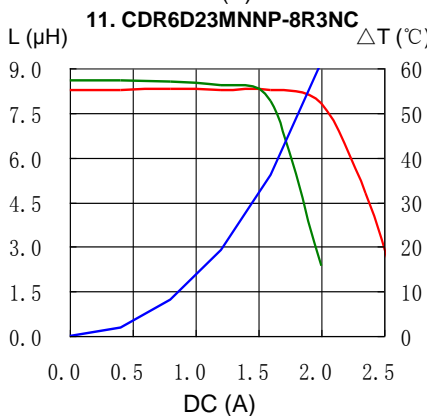
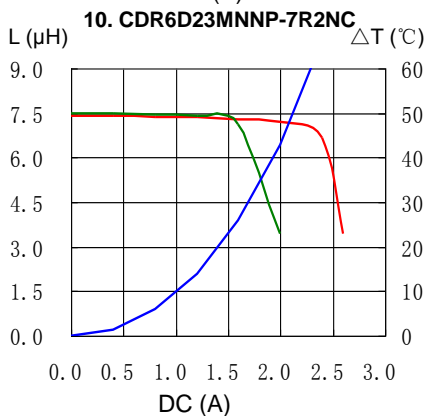
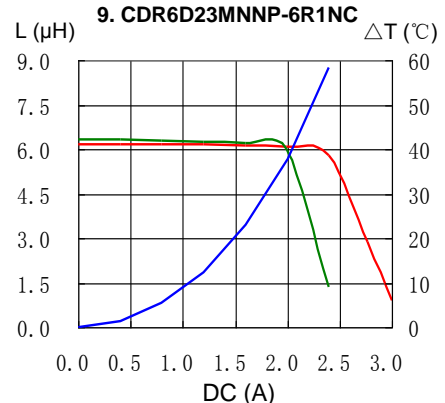
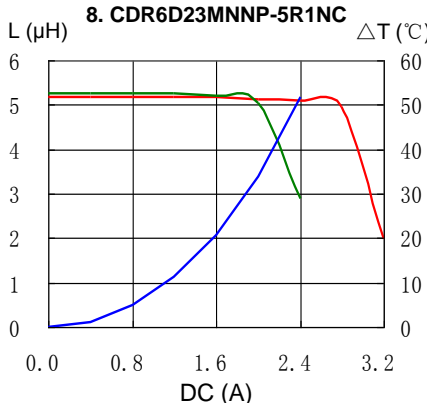
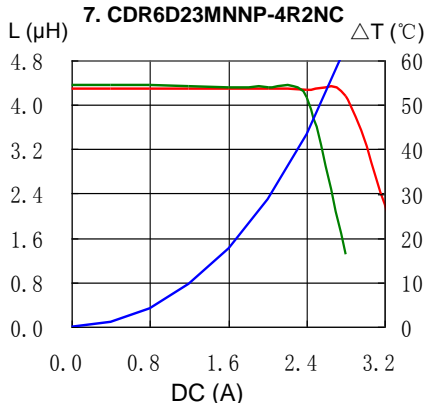
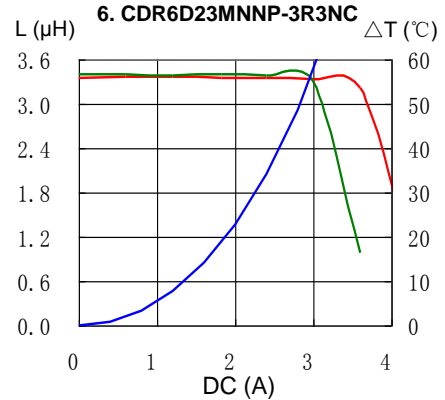
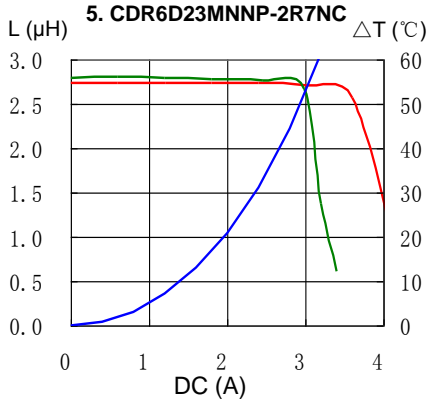
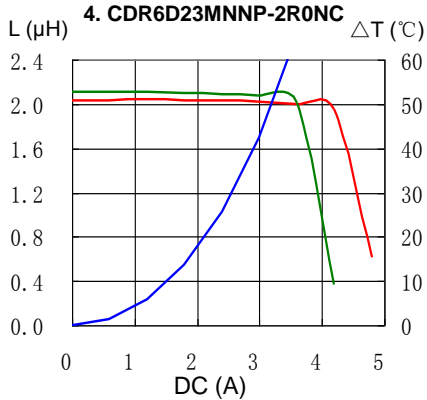
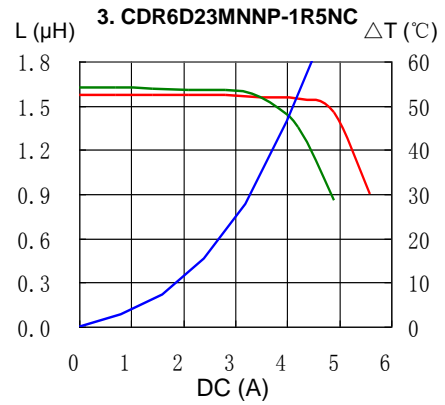
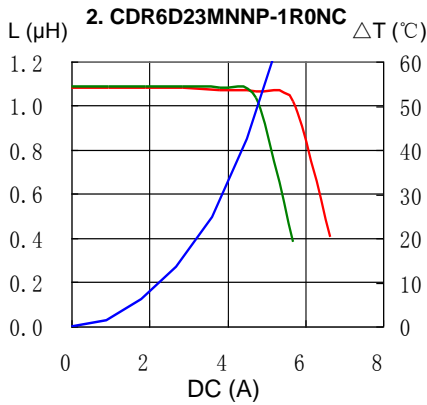
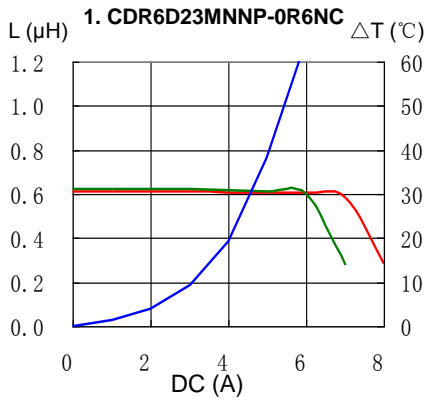

SMD Power Inductor CDR6D23MN



Saturation Current & Temperature Rise Graph

— L (20°C) — L (105°C) — ΔT

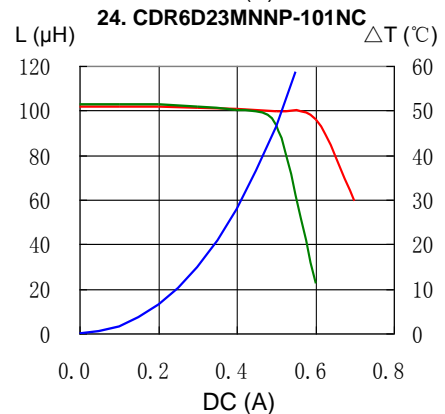
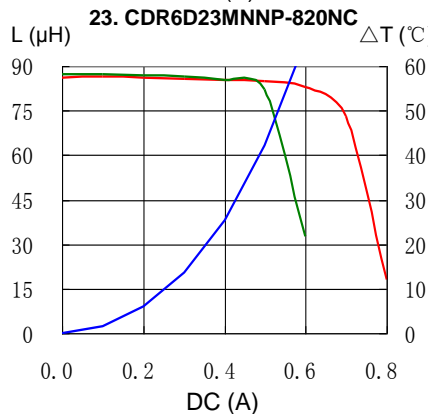
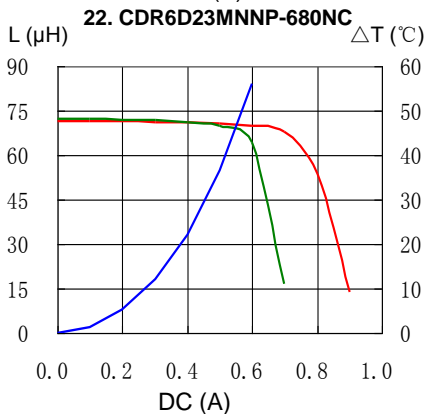
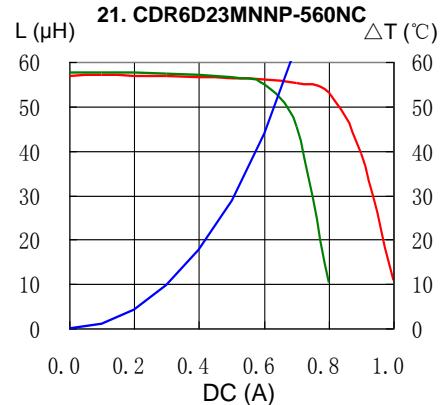
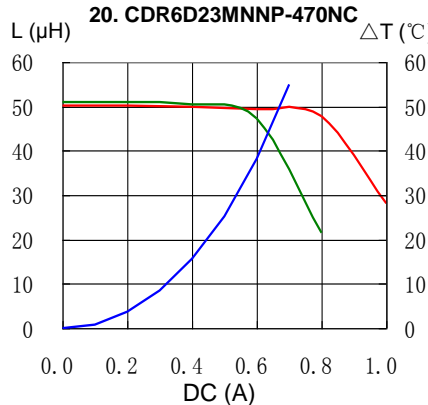
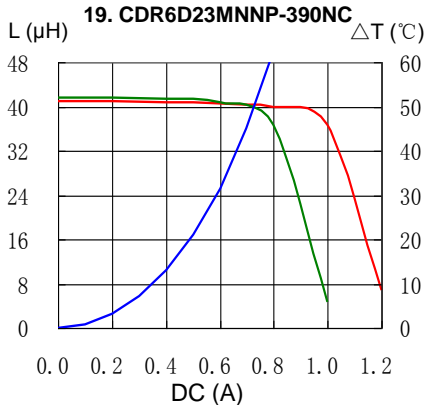
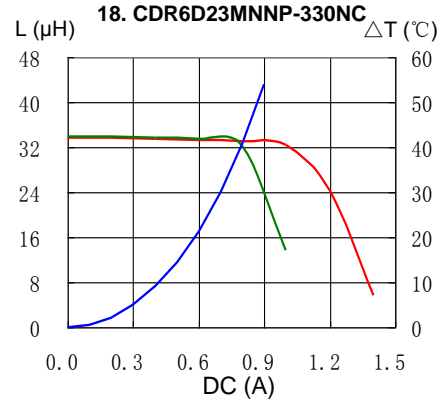
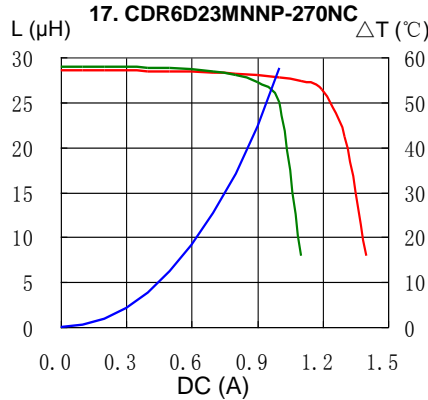
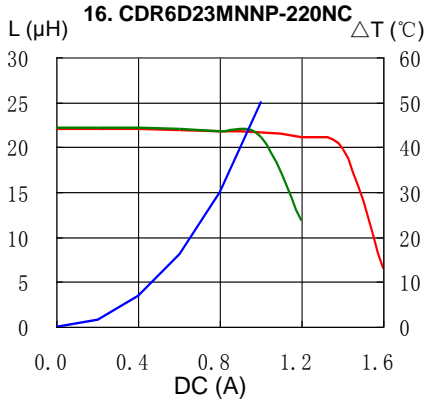
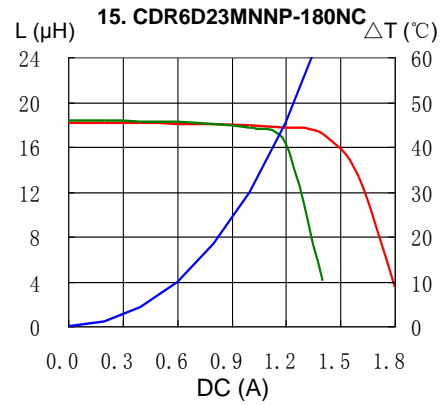
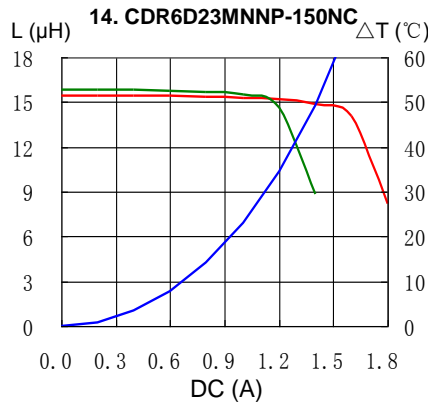
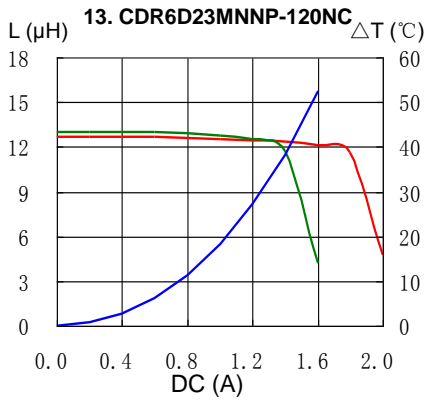

SMD Power Inductor CDR6D23MN



Solder Reflow Condition

Heat Endurance

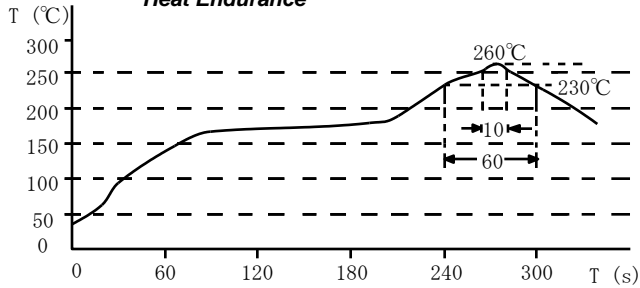

Temperature Chart

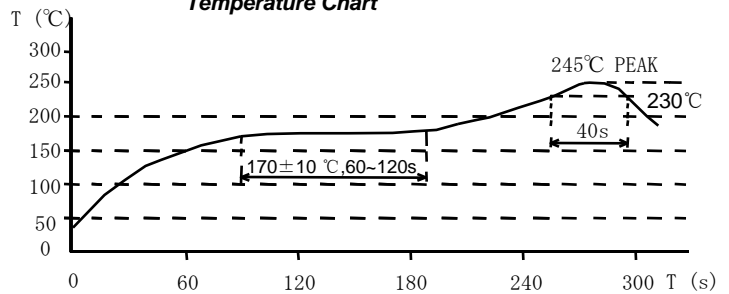

Please refer to the sales offices on our website - <http://www.sumida.com>

Hong Kong

Tel.+852-2880-6781
FAX.+852-2565-9600
sales@hk.sumida.com

Saitama(Japan)

Tel.+81-48-691-7300
FAX.+81-48-691-7340
sales@jp.sumida.com

Chicago

Tel.+1-847-545-6700
FAX. +1-847-545-6720
sales@us.sumida.com

Shanghai

Tel.+86-21-5836-3299
FAX.+86-21-5836-3266
shanghai.sales@cn.sumida.com

Seoul

Tel.+82-2-6237-0777
FAX.+82-2-6237-0778
sales@kr.sumida.com

Obernzell

Tel.+49-8591-937-0
FAX. +49-8591-937-103
contact@eu.sumida.com

Shenzhen

Tel.+86-755-8291-0228
FAX.+86-755-8291-0338
shenzhen.sales@cn.sumida.com

Singapore

Tel.+65-6296-3388
FAX.+65-6841-4426
sales@sg.sumida.com

Neumarkt

Tel.+49-9181-4509-110
FAX. +49-9181-4509-310
infocomp@eu.sumida.com

Taipei

Tel.+886-2-8751-2737
FAX.+886-2-8751-2738
sales@tw.sumida.com

San Jose

Tel.+1-408-321-9660
FAX.+1-408-321-9308
sales@us.sumida.com