

SMD Power Inductor CDR6D28MN



Description

- Ferrite drum core construction.
- Magnetically shielded.
- L × W × H: 6.8 × 6.8 × 3.0 mm Max.
- Product weight: 0.35 g(Ref.)
- Moisture Sensitivity Level: 1
- RoHS compliance.

Environmental Data

- Operating temperature range: -40°C ~ +105°C (including coil's self temperature rise)
- Storage temperature range: -40°C ~ +105°C
- Solder reflow temperature: 260 °C peak.

Packaging

- Carrier tape and reel packaging
- 12.9" diameter reel
- 1500pcs per reel

Applications

- Ideally used in LCD driver, DSC/DVC , Notebook PC or the other portable equipment

Dimension - [mm]

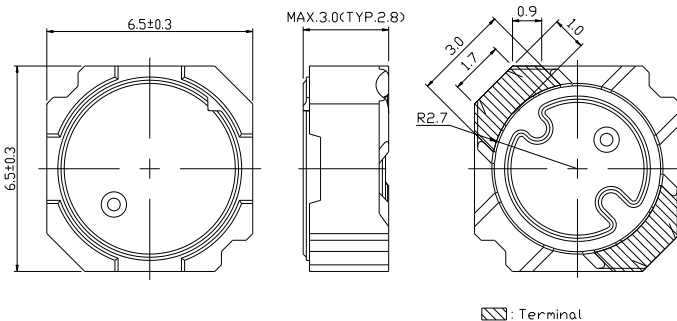

Land pattern and Schematics - [mm]

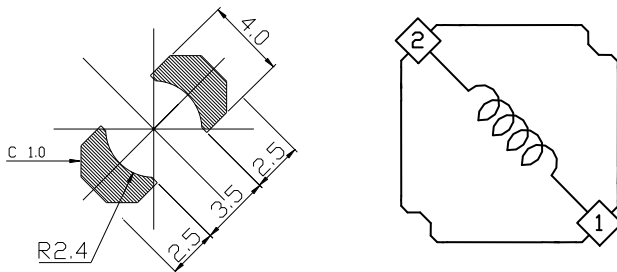



Electrical Characteristics

Part Name	Stamp	Inductance (μH) [within] ※1	D.C.R. (m Ω) Max. (Typ.) (at 20°C)	Saturation Current (A) ※2		Temperature Rise Current (A) ※3
				(at 20°C)	(at 105°C)	
CDR6D28MNNP-1R5NC	1R5	1.5 $\mu\text{H} \pm 25\%$	31.5(25)	5.90	4.55	3.0
CDR6D28MNNP-2R0NC	2R0	2.0 $\mu\text{H} \pm 25\%$	37.5(30)	4.75	3.90	2.9
CDR6D28MNNP-2R7NC	2R7	2.7 $\mu\text{H} \pm 25\%$	43.8(35)	4.30	3.45	2.7
CDR6D28MNNP-3R6NC	3R6	3.6 $\mu\text{H} \pm 25\%$	50.0(40)	3.90	3.05	2.5
CDR6D28MNNP-4R5NC	4R5	4.5 $\mu\text{H} \pm 25\%$	57.5(46)	3.55	2.75	2.4
CDR6D28MNNP-5R5NC	5R5	5.5 $\mu\text{H} \pm 25\%$	63.8(51)	3.15	2.50	2.2
CDR6D28MNNP-6R5NC	6R5	6.5 $\mu\text{H} \pm 25\%$	70.0(56)	3.05	2.40	2.1
CDR6D28MNNP-7R7NC	7R7	7.7 $\mu\text{H} \pm 25\%$	76.3(61)	2.85	2.30	2.0
CDR6D28MNNP-9R0NC	9R0	9.0 $\mu\text{H} \pm 25\%$	82.5(66)	2.60	2.10	1.9
CDR6D28MNNP-100NC	100	10 $\mu\text{H} \pm 25\%$	88.8(71)	2.50	2.00	1.8
CDR6D28MNNP-120NC	120	12 $\mu\text{H} \pm 25\%$	120.0(96)	2.30	1.75	1.5
CDR6D28MNNP-150NC	150	15 $\mu\text{H} \pm 25\%$	135.0(108)	2.10	1.55	1.4
CDR6D28MNNP-180NC	180	18 $\mu\text{H} \pm 25\%$	150.0(121)	1.75	1.45	1.3
CDR6D28MNNP-220NC	220	22 $\mu\text{H} \pm 25\%$	198.8(159)	1.65	1.25	1.1
CDR6D28MNNP-270NC	270	27 $\mu\text{H} \pm 25\%$	231.2(185)	1.45	1.15	0.98
CDR6D28MNNP-330NC	330	33 $\mu\text{H} \pm 25\%$	308.8(247)	1.25	1.05	0.94
CDR6D28MNNP-390NC	390	39 $\mu\text{H} \pm 25\%$	335.0(268)	1.15	0.95	0.90
CDR6D28MNNP-470NC	470	47 $\mu\text{H} \pm 25\%$	458.8(367)	1.05	0.90	0.72
CDR6D28MNNP-560NC	560	56 $\mu\text{H} \pm 25\%$	501.3(401)	1.00	0.80	0.68
CDR6D28MNNP-680NC	680	68 $\mu\text{H} \pm 25\%$	561.3(449)	0.90	0.75	0.65
CDR6D28MNNP-820NC	820	82 $\mu\text{H} \pm 25\%$	837.5(670)	0.80	0.65	0.53
CDR6D28MNNP-101NC	101	100 $\mu\text{H} \pm 25\%$	936.3(749)	0.75	0.60	0.50
CDR6D28MNNP-121NC	121	120 $\mu\text{H} \pm 25\%$	1028.8(823)	0.70	0.55	0.46

※1. Inductance measuring condition: at 100kHz.

※2. Saturation current: The value of D.C. current when the inductance decreases to 65% of it's nominal value.

※3. Temperature rise current: The value of D.C. current when the temperature rise is $\Delta t = 40^\circ\text{C}$ ($T_a = 20^\circ\text{C}$).

SMD Power Inductor CDR6D28MN

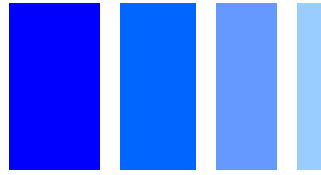

Saturation Current & Temperature Rise Graph

— L (20°C) — L (100°C) — ΔT

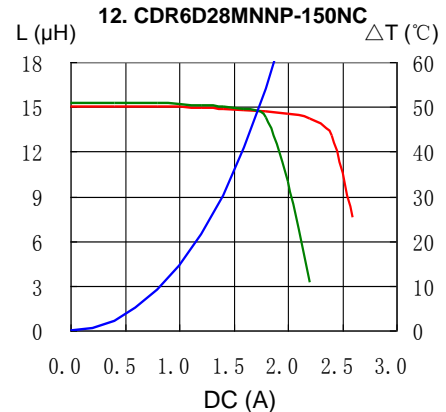
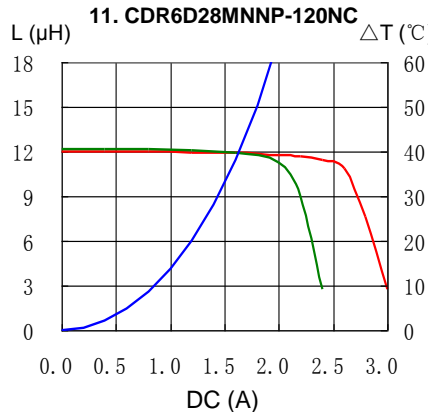
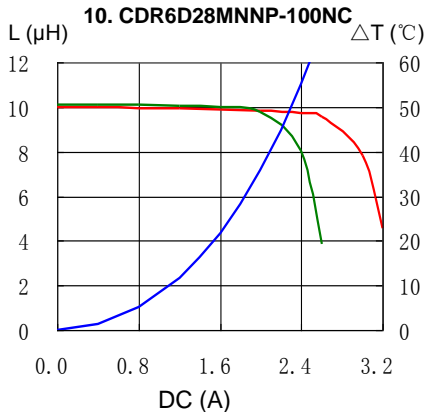
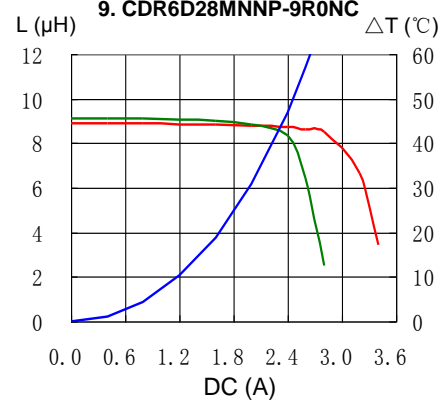
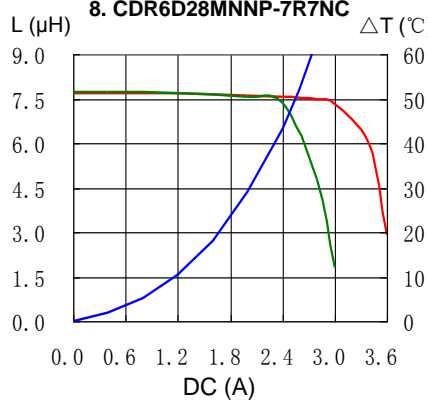
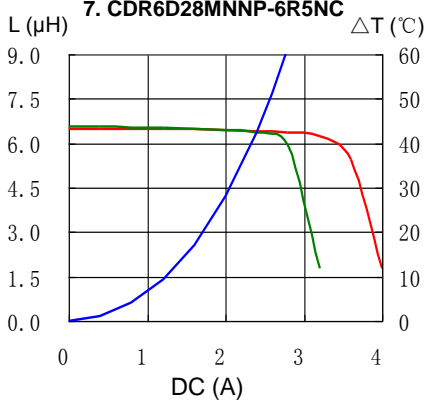
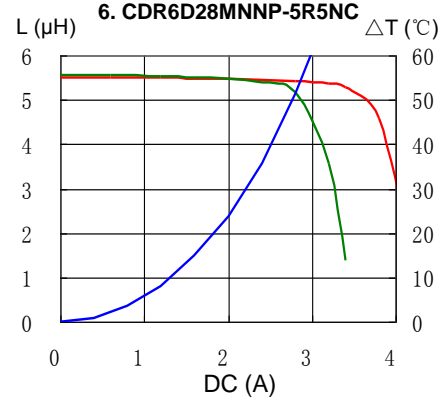
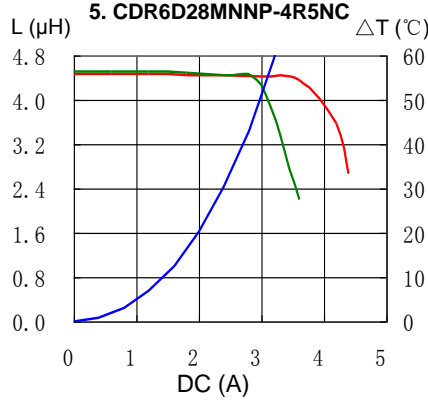
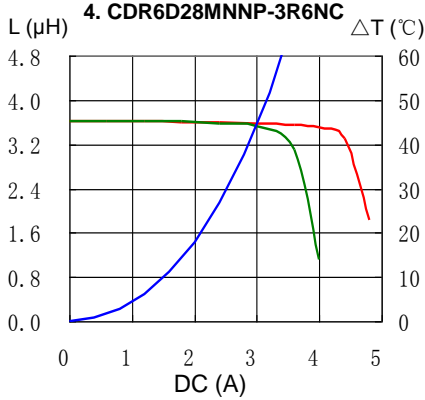
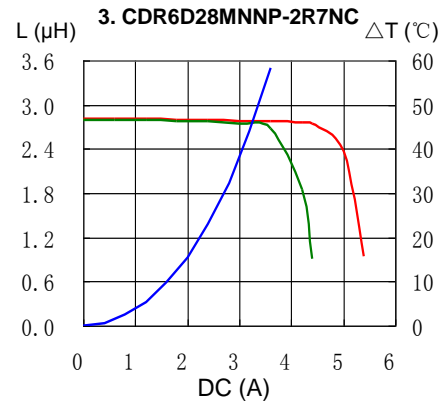
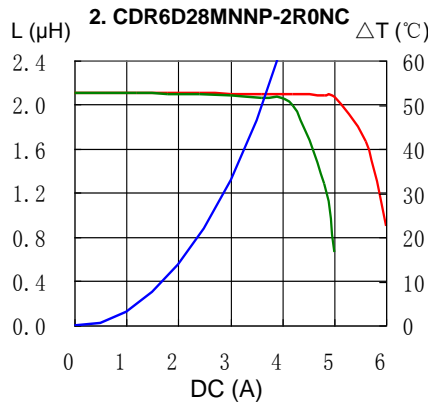
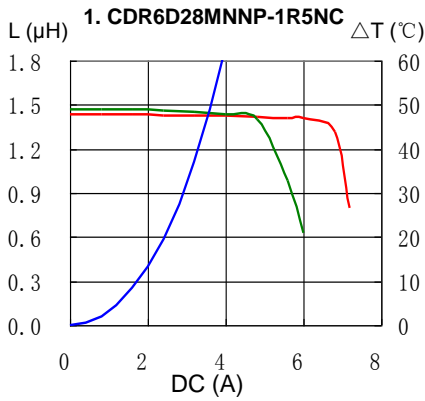

SMD Power Inductor CDR6D28MN



Saturation Current & Temperature Rise Graph

— L (20°C) — L (100°C) — ΔT

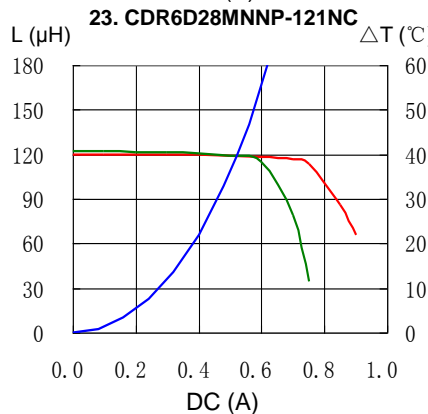
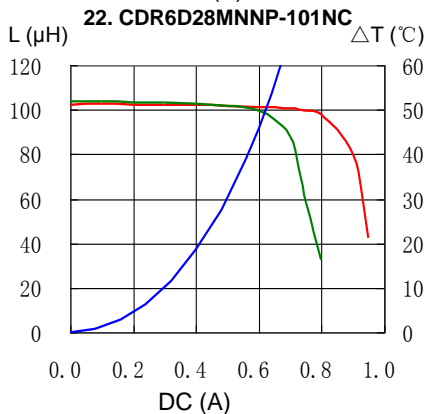
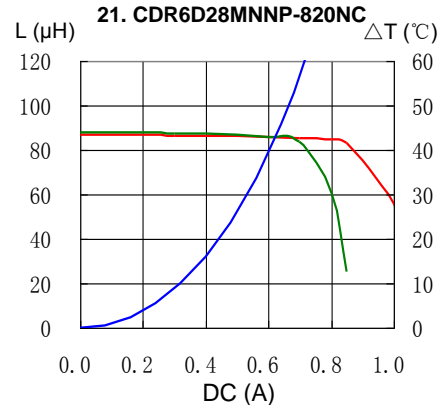
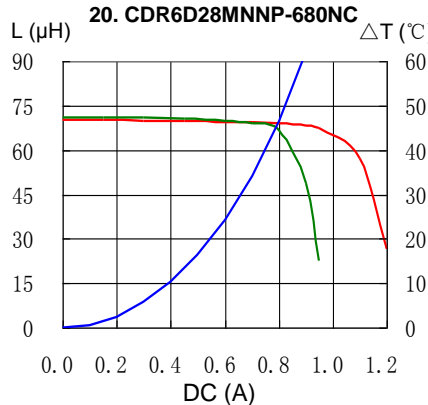
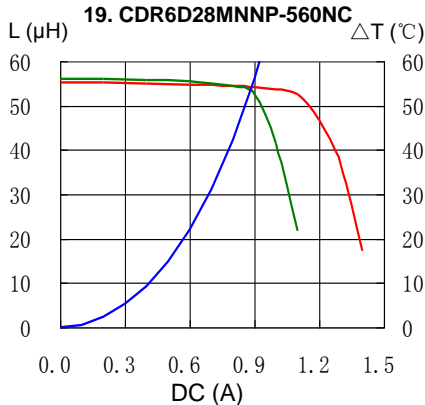
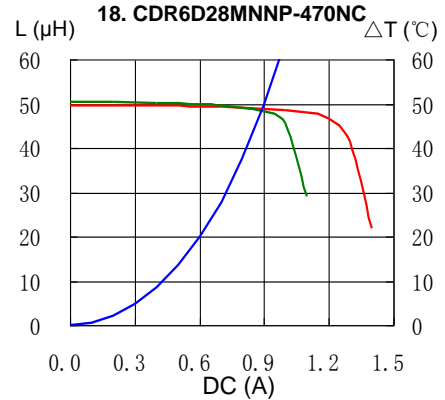
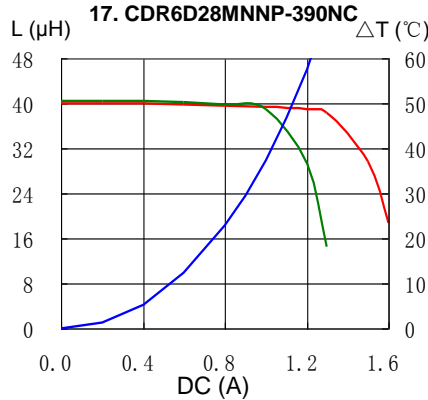
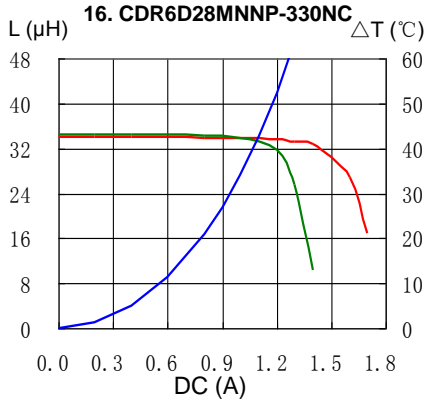
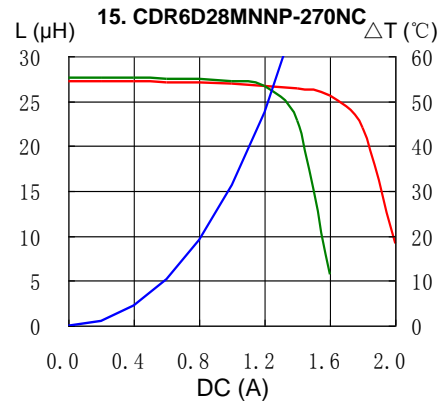
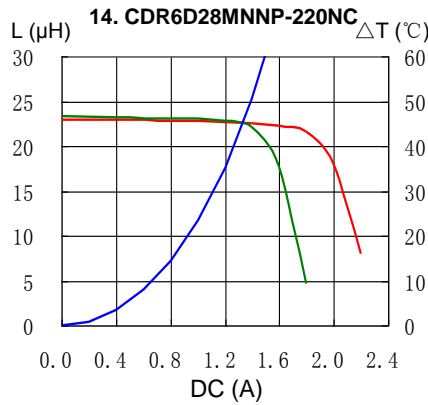
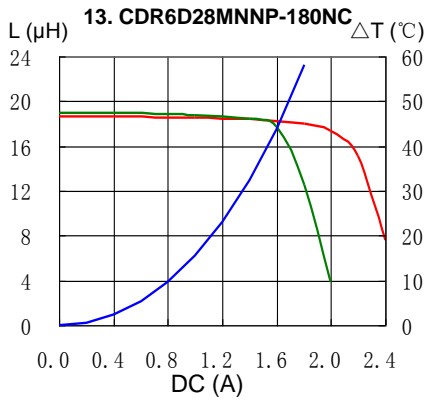

SMD Power Inductor CDR6D28MN

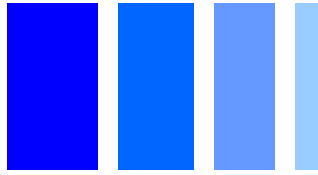

Solder Reflow Condition

Heat Endurance

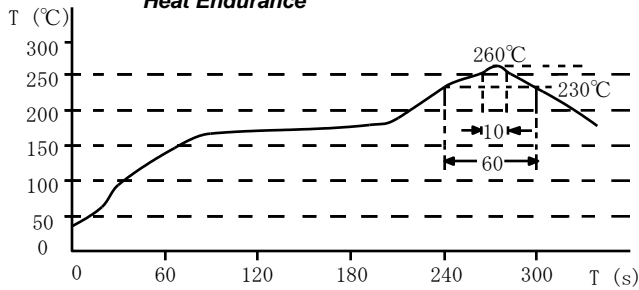

Temperature Chart

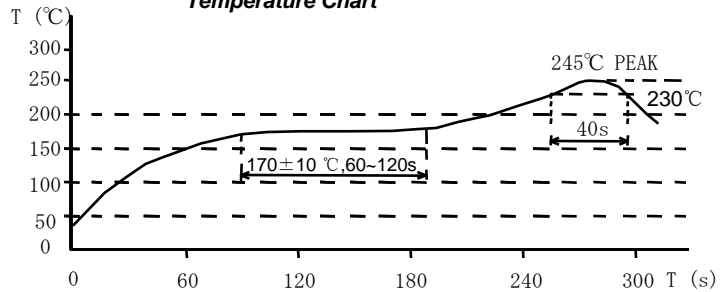

Please refer to the sales offices on our website - <http://www.sumida.com>

Hong Kong

Tel.+852-2880-6781
FAX.+852-2565-9600
sales@hk.sumida.com

Saitama(Japan)

Tel.+81-48-691-7300
FAX.+81-48-691-7340
sales@jp.sumida.com

Chicago

Tel.+1-847-545-6700
FAX. +1-847-545-6720
sales@us.sumida.com

Shanghai

Tel.+86-21-5836-3299
FAX.+86-21-5836-3266
shanghai.sales@cn.sumida.com

Seoul

Tel.+82-2-6237-0777
FAX.+82-2-6237-0778
sales@kr.sumida.com

Obernzell

Tel.+49-8591-937-0
FAX. +49-8591-937-103
contact@eu.sumida.com

Shenzhen

Tel.+86-755-8291-0228
FAX.+86-755-8291-0338
shenzhen.sales@cn.sumida.com

Singapore

Tel.+65-6296-3388
FAX.+65-6841-4426
sales@sg.sumida.com

Neumarkt

Tel.+49-9181-4509-110
FAX. +49-9181-4509-310
infocomp@eu.sumida.com

Taipei

Tel.+886-2-8751-2737
FAX.+886-2-8751-2738
sales@tw.sumida.com

San Jose

Tel.+1-408-321-9660
FAX.+1-408-321-9308
sales@us.sumida.com