

# SMD Power Inductor CDRH125/LD



## Description

- Ferrite drum core construction.
- Magnetically shielded.
- L × W × H: 12.3 × 12.3 × 6.0 mm Max.
- Product weight: 2.9g(Ref.)
- Moisture Sensitivity Level: 1
- RoHS compliance.

## Environmental Data

- Operating temperature range: -40°C ~ +100°C (including coil's self temperature rise)
- Storage temperature range: -40°C ~ +100°C
- Solder reflow temperature: 260 °C peak.

## Packaging

- Carrier tape and reel packaging
- 13" diameter reel
- 500pcs per reel

## Applications

- Ideally used in Notebook PC, LCD TV, DVD, Game machine, STB, Projector etc. as converter inductors.

## Dimension - [mm]

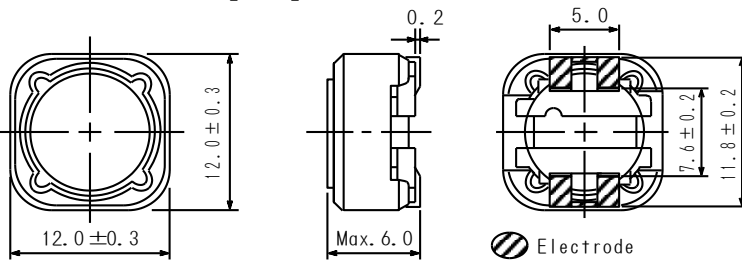

## Land pattern and Schematics - [mm]

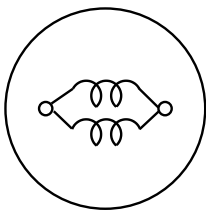
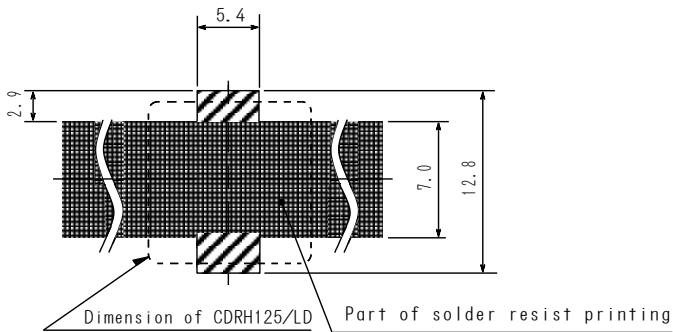

7.5µH ~ 56µH

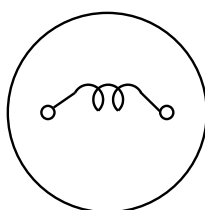

68µH ~ 1000µH

# SMD Power Inductor

## CDRH125/LD



### Electrical Characteristics

Part No.	Stamp	Inductance ( $\mu\text{H}$ ) [ within ] ※1	D.C.R ( $\Omega$ ) [Max.] (Typ.)	Rated Current (A) ※2
CDRH125/LDNP-7R5NC	7R5	$7.5 \pm 30\%$	19.0m(14.7m)	5.60
CDRH125/LDNP-100NC	100	$10 \pm 30\%$	29.0m(22.5m)	4.60
CDRH125/LDNP-120MC	120	$12 \pm 20\%$	32.0m(24.6m)	4.20
CDRH125/LDNP-150MC	150	$15 \pm 20\%$	35.0m(27.1m)	4.00
CDRH125/LDNP-180MC	180	$18 \pm 20\%$	41.0m(31.8m)	3.56
CDRH125/LDNP-220MC	220	$22 \pm 20\%$	44.0m(33.9m)	3.28
CDRH125/LDNP-270MC	270	$27 \pm 20\%$	52.0m(41.5m)	3.00
CDRH125/LDNP-330MC	330	$33 \pm 20\%$	65.0m(50.0m)	2.60
CDRH125/LDNP-390MC	390	$39 \pm 20\%$	75.0m(60.0m)	2.40
CDRH125/LDNP-470MC	470	$47 \pm 20\%$	95.0m(72.5m)	2.30
CDRH125/LDNP-560MC	560	$56 \pm 20\%$	125m(95.4m)	2.00
CDRH125/LDNP-680MC	680	$68 \pm 20\%$	0.140(0.11)	1.85
CDRH125/LDNP-820MC	820	$82 \pm 20\%$	0.157(0.121)	1.70
CDRH125/LDNP-101MC	101	$100 \pm 20\%$	0.187(0.144)	1.60
CDRH125/LDNP-121MC	121	$120 \pm 20\%$	0.228(0.175)	1.37
CDRH125/LDNP-151MC	151	$150 \pm 20\%$	0.280(0.218)	1.26
CDRH125/LDNP-181MC	181	$180 \pm 20\%$	0.335(0.259)	1.14
CDRH125/LDNP-221MC	221	$220 \pm 20\%$	0.395(0.303)	1.08
CDRH125/LDNP-271MC	271	$270 \pm 20\%$	0.520(0.403)	0.94
CDRH125/LDNP-331MC	331	$330 \pm 20\%$	0.710(0.547)	0.85
CDRH125/LDNP-391MC	391	$390 \pm 20\%$	0.800(0.614)	0.77
CDRH125/LDNP-471MC	471	$470 \pm 20\%$	0.920(0.711)	0.72
CDRH125/LDNP-561MC	561	$560 \pm 20\%$	1.20(0.956)	0.67
CDRH125/LDNP-681MC	681	$680 \pm 20\%$	1.35(1.08)	0.57
CDRH125/LDNP-821MC	821	$820 \pm 20\%$	1.40(1.17)	0.51
CDRH125/LDNP-102MC	102	$1000 \pm 20\%$	1.95(1.62)	0.46

※1. Inductance measuring condition: Inductance  $\leq 10\mu\text{H}$  at 7.96MHz; Inductance  $> 10\mu\text{H}$  at 100kHz

※2. Rated current: The DC current at which the inductance decreases to 75% of its nominal value or when  $\Delta t = 40^\circ\text{C}$ , whichever is lower.

# SMD Power Inductor CDRH125/LD



## Saturation Current & Temperature Rise Graph

— L (20°C)    —  $\Delta T$

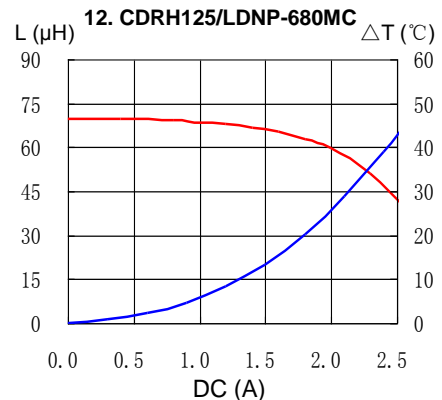
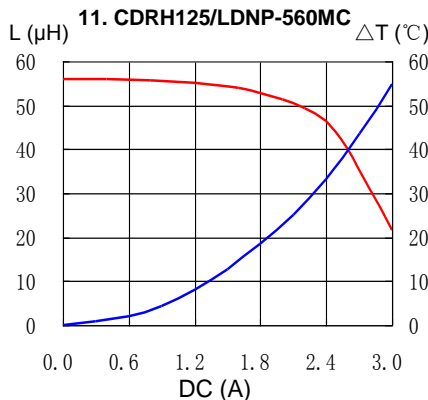
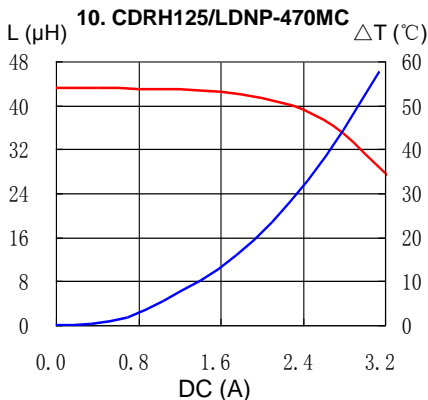
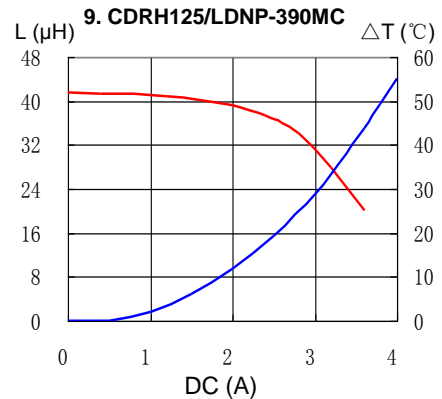
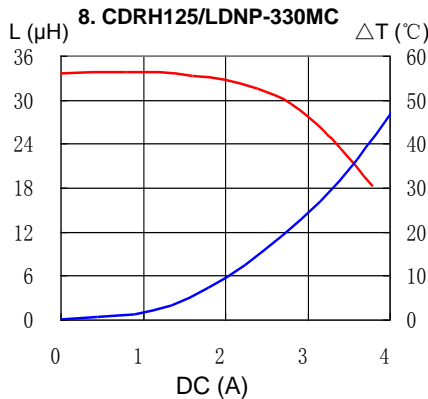
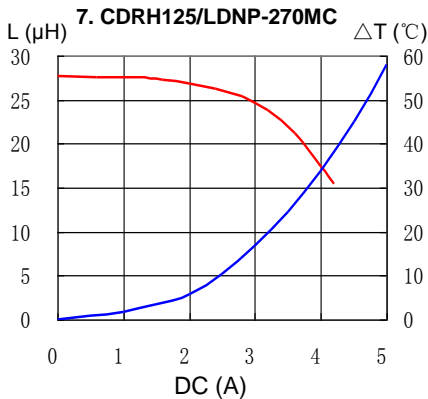
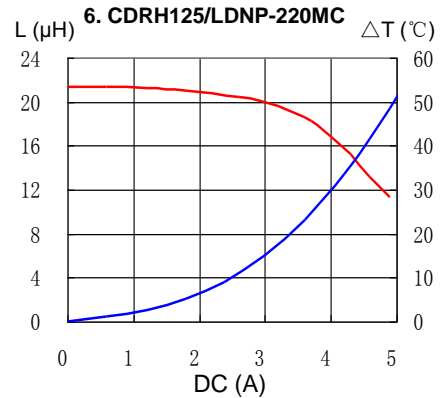
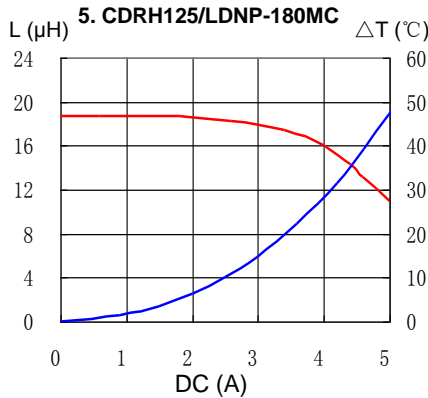
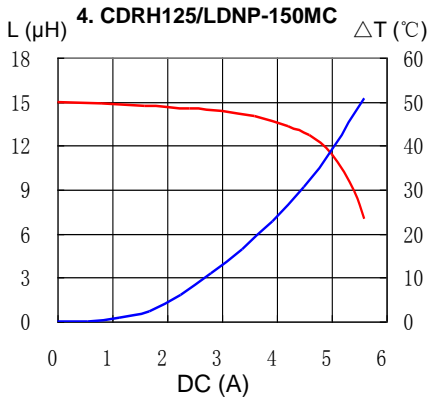
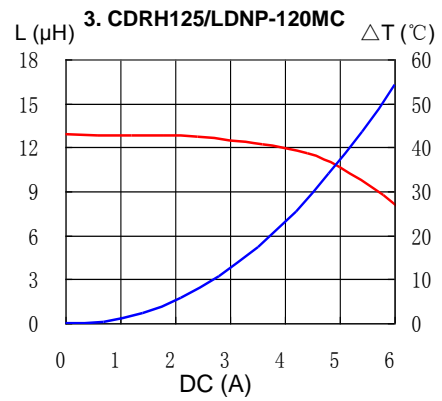
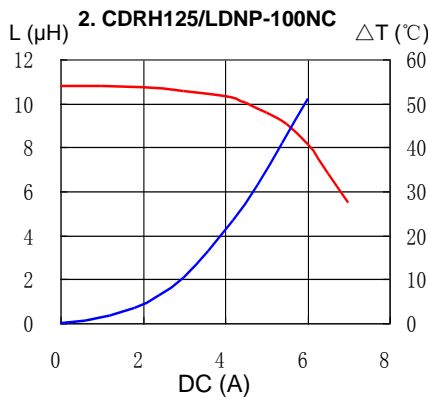
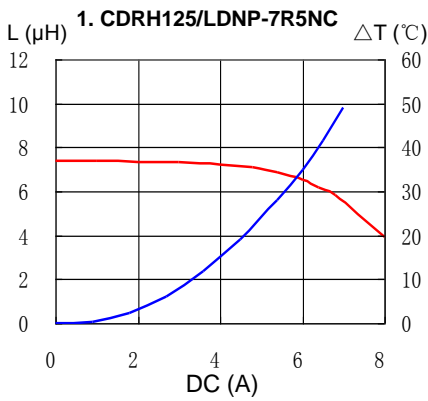

# SMD Power Inductor CDRH125/LD



## Saturation Current & Temperature Rise Graph

— L (20°C)    —  $\Delta T$

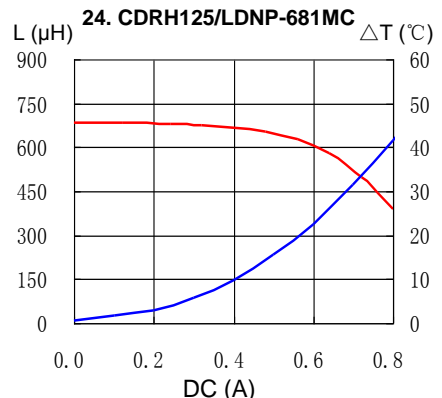
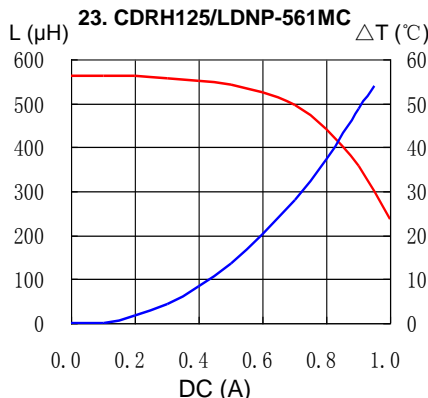
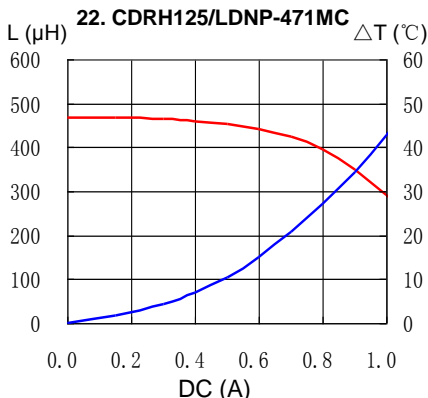
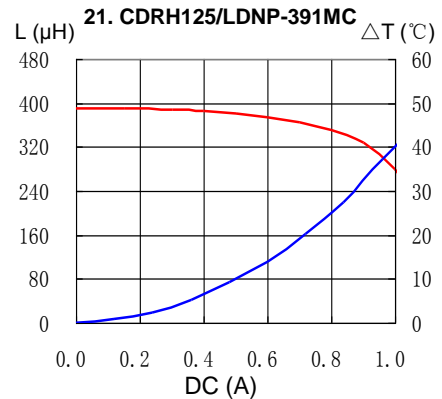
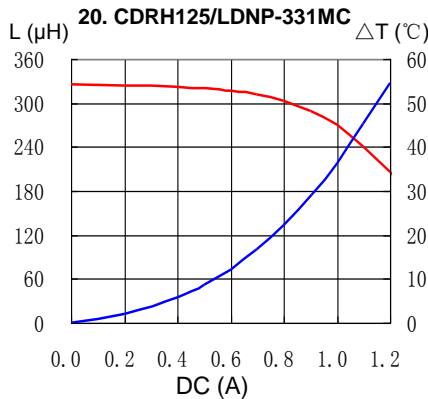
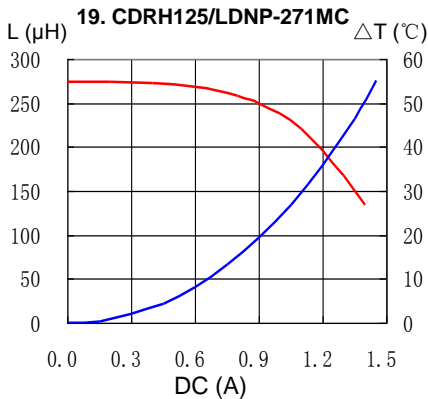
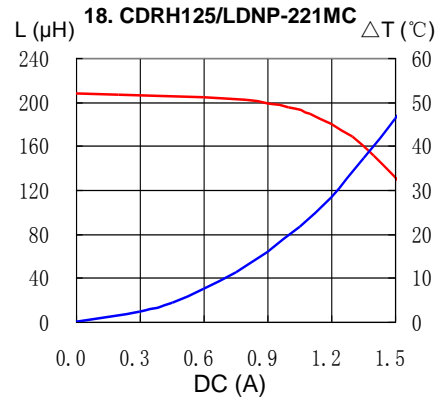
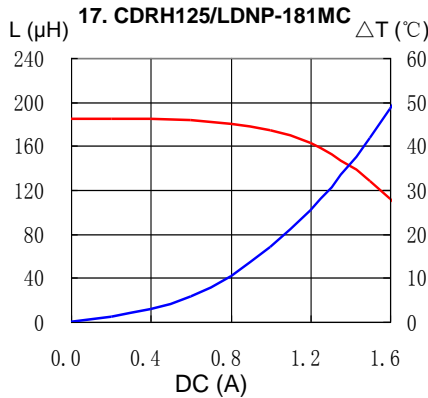
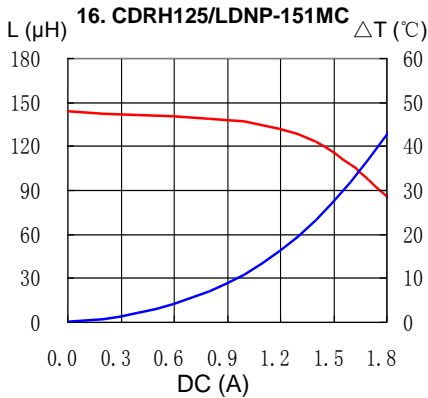
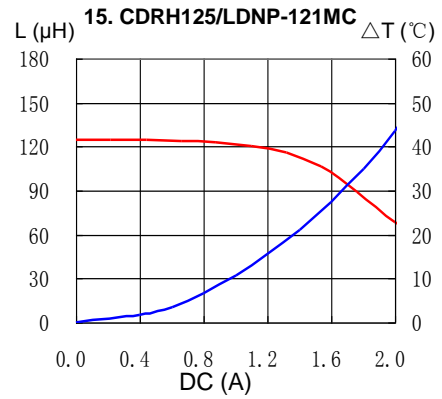
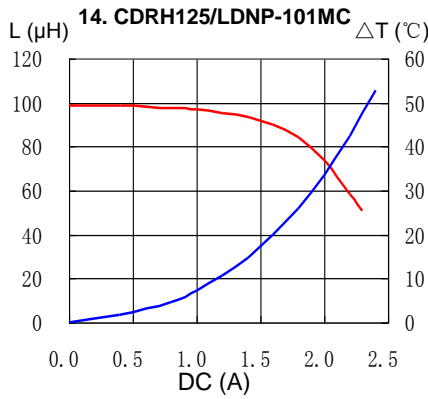
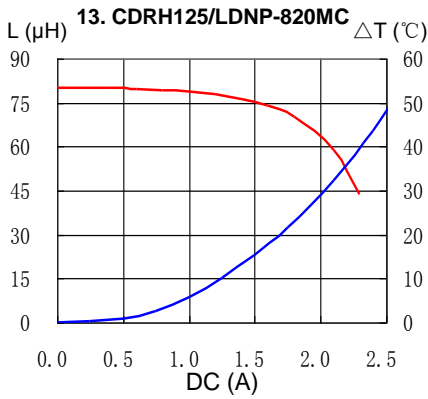

# SMD Power Inductor CDRH125/LD



## Saturation Current & Temperature Rise Graph

— L (20°C)    —  $\Delta T$

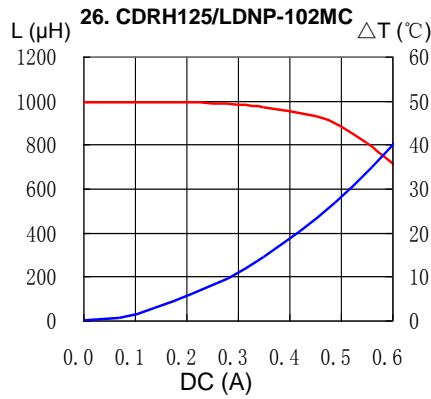
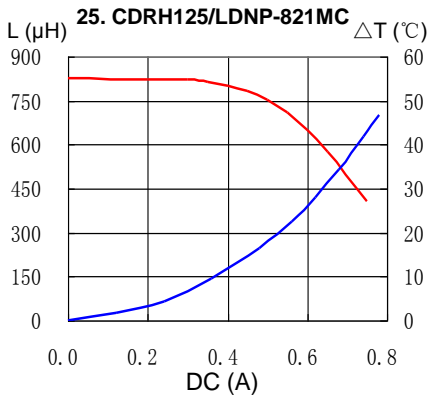

## Solder Reflow Condition

**Heat Endurance**

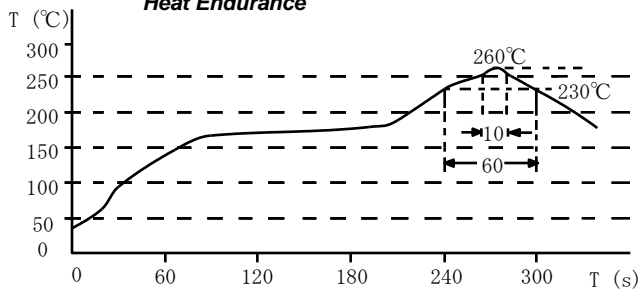

**Temperature Chart**

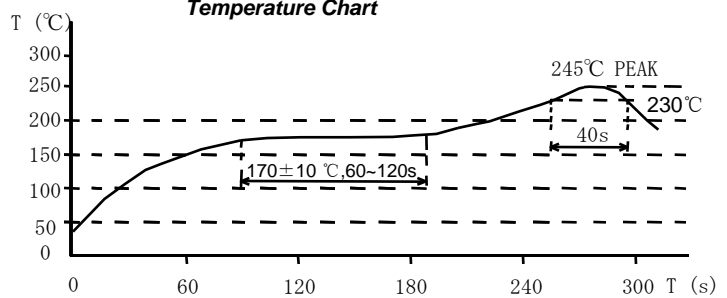

Please refer to the sales offices on our website - <http://www.sumida.com>

### Hong Kong

Tel. +852-2880-6781  
FAX. +852-2565-9600  
[sales@hk.sumida.com](mailto:sales@hk.sumida.com)

### Saitama(Japan)

Tel. +81-48-691-7300  
FAX. +81-48-691-7340  
[sales@jp.sumida.com](mailto:sales@jp.sumida.com)

### Chicago

Tel. +1-847-545-6700  
FAX. +1-847-545-6720  
[sales@us.sumida.com](mailto:sales@us.sumida.com)

### Shanghai

Tel. +86-21-5836-3299  
FAX. +86-21-5836-3266  
[shanghai.sales@cn.sumida.com](mailto:shanghai.sales@cn.sumida.com)

### Seoul

Tel. +82-2-6237-0777  
FAX. +82-2-6237-0778  
[sales@kr.sumida.com](mailto:sales@kr.sumida.com)

### Obernzell

Tel. +49-8591-937-0  
FAX. +49-8591-937-103  
[contact@eu.sumida.com](mailto:contact@eu.sumida.com)

### Shenzhen

Tel. +86-755-8291-0228  
FAX. +86-755-8291-0338  
[shenzhen.sales@cn.sumida.com](mailto:shenzhen.sales@cn.sumida.com)

### Singapore

Tel. +65-6296-3388  
FAX. +65-6841-4426  
[sales@sg.sumida.com](mailto:sales@sg.sumida.com)

### Neumarkt

Tel. +49-9181-4509-110  
FAX. +49-9181-4509-310  
[infocomp@eu.sumida.com](mailto:infocomp@eu.sumida.com)

### Taipei

Tel. +886-2-8751-2737  
FAX. +886-2-8751-2738  
[sales@tw.sumida.com](mailto:sales@tw.sumida.com)

### San Jose

Tel. +1-408-321-9660  
FAX. +1-408-321-9308  
[sales@us.sumida.com](mailto:sales@us.sumida.com)