

# SMD Power Inductor CDRH3D14/LD

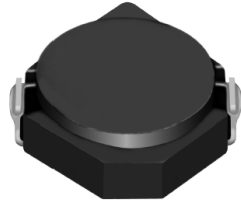

## Description

- Ferrite drum core construction.
- Magnetically shielded.
- L × W × H: 4.0 × 4.0 × 1.5 mm Max.
- Product weight: 70mg(Ref.)
- Moisture Sensitivity Level: 1
- RoHS compliance.

## Environmental Data

- Operating temperature range: -40°C ~ +105°C (including coil's self temperature rise)
- Storage temperature range: -40°C ~ +105°C
- Solder reflow temperature: 260 °C peak.

## Packaging

- Carrier tape and reel packaging
- 7.0" diameter reel
- 1000pcs per reel

## Applications

- Ideally used in Mobile phone, PDA, MP3, DSC/DVC, Portable DVD, etc as DC-DC converter inductors.

## Dimension - [mm]

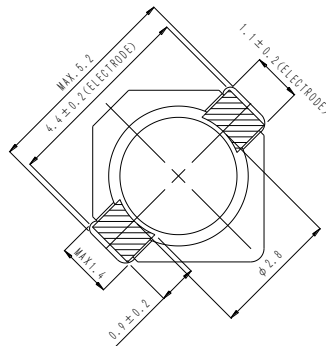
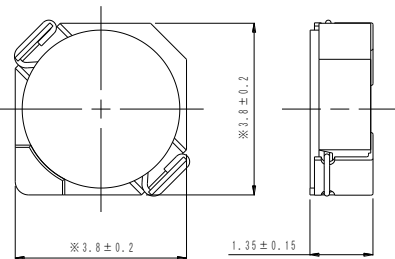

## Land pattern and Schematics - [mm]

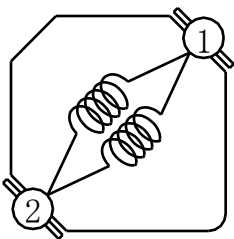
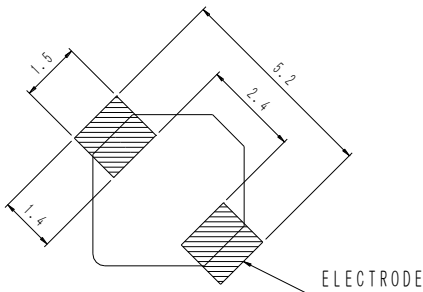

(1.2μH~3.0μH)

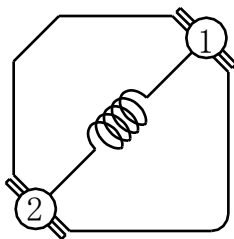

(3.9μH~47μH)



### Electrical Characteristics

Part Name	Stamp	Inductance ( $\mu\text{H}$ ) [ within ] ※1	D.C.R. (m $\Omega$ ) Max. (Typ.) (at 20°C)	Saturation Current (A) ※2		Temperature Rise Current (A) ※3
				at 20°C	at 100°C	
CDRH3D14/LDNP-1R2NC	A	1.2 $\pm$ 25%	38 (30)	1.50	1.28	2.70
CDRH3D14/LDNP-1R5NC	B	1.5 $\pm$ 25%	48 (38)	1.35	1.05	2.40
CDRH3D14/LDNP-2R0NC	C	2.0 $\pm$ 25%	55 (44)	1.15	0.95	2.20
CDRH3D14/LDNP-2R5NC	D	2.5 $\pm$ 25%	68 (54)	1.05	0.80	1.90
CDRH3D14/LDNP-3R0NC	E	3.0 $\pm$ 25%	77 (62)	0.95	0.75	1.60
CDRH3D14/LDNP-3R9NC	F	3.9 $\pm$ 25%	96 (77)	0.80	0.65	1.50
CDRH3D14/LDNP-4R5NC	G	4.5 $\pm$ 25%	105 (84)	0.75	0.60	1.45
CDRH3D14/LDNP-5R6NC	H	5.6 $\pm$ 25%	159 (127)	0.70	0.55	1.10
CDRH3D14/LDNP-6R8NC	I	6.8 $\pm$ 25%	173 (138)	0.60	0.50	1.05
CDRH3D14/LDNP-100NC	K	10 $\pm$ 25%	220 (176)	0.50	0.38	1.00
CDRH3D14/LDNP-120NC	L	12 $\pm$ 25%	270 (216)	0.45	0.35	0.80
CDRH3D14/LDNP-150NC	M	15 $\pm$ 25%	302 (242)	0.40	0.30	0.75
CDRH3D14/LDNP-220NC	O	22 $\pm$ 25%	447 (358)	0.35	0.27	0.60
CDRH3D14/LDNP-330NC	Q	33 $\pm$ 25%	848 (679)	0.30	0.25	0.40
CDRH3D14/LDNP-470NC	R	47 $\pm$ 25%	1078 (863)	0.25	0.20	0.35

※1. Inductance measuring condition: at 100kHz.

※2. Saturation current: The value of D.C. current when the inductance decreases to 65% of it's nominal value.

※3. Temperature rise current: The value of D.C. current when the temperature rise is  $\Delta t=40^\circ\text{C}$  ( $T_a=20^\circ\text{C}$ ).

# SMD Power Inductor CDRH3D14/LD



## Saturation Current & Temperature Rise Graph

— L (20°C) — L (105°C) —  $\Delta T$

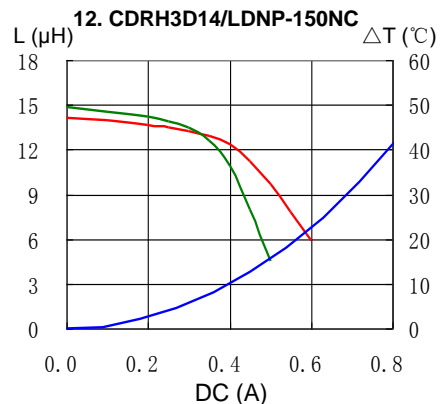
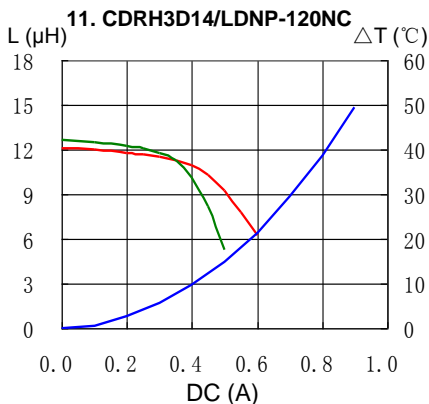
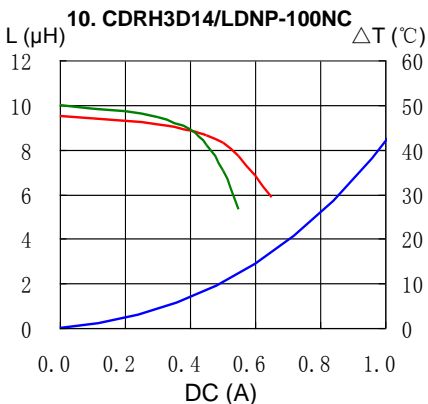
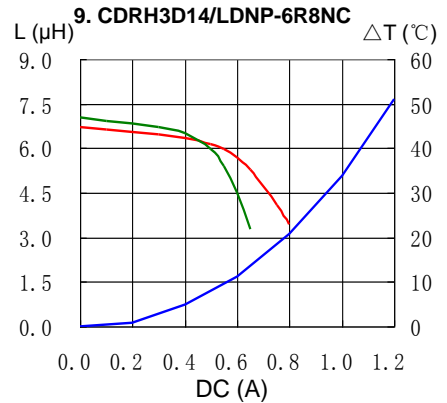
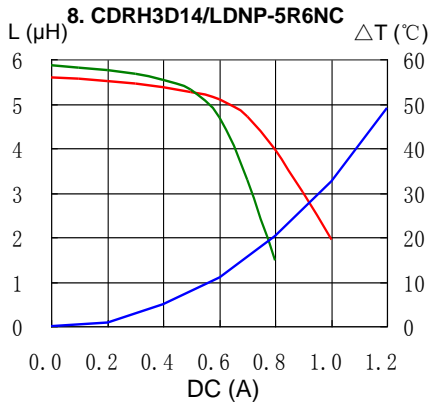
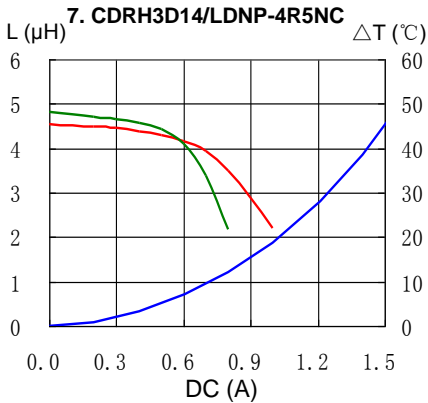
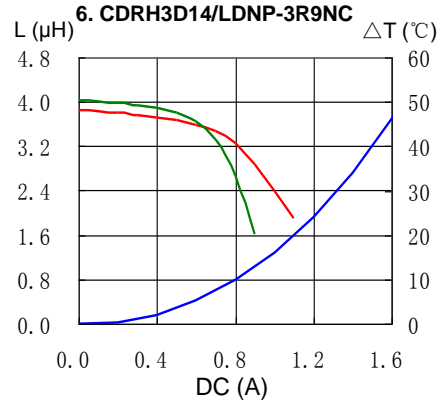
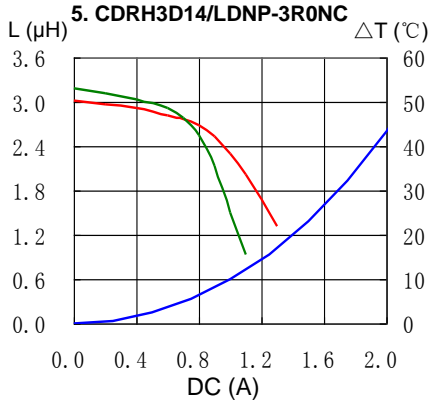
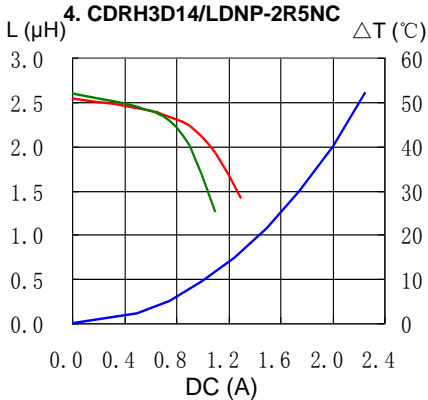
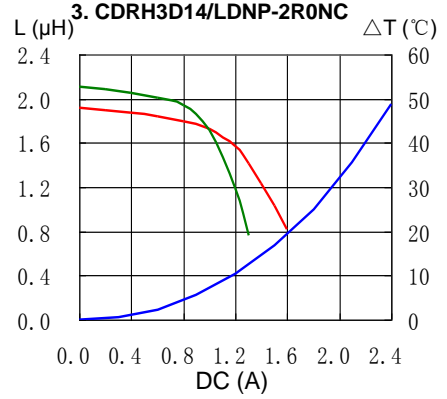
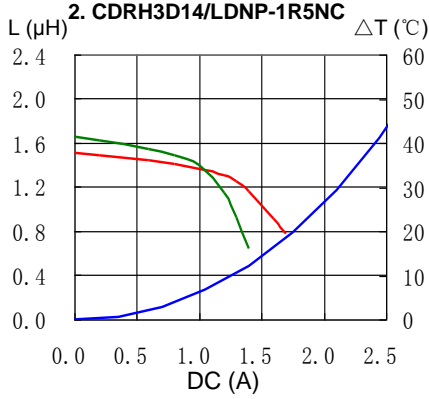
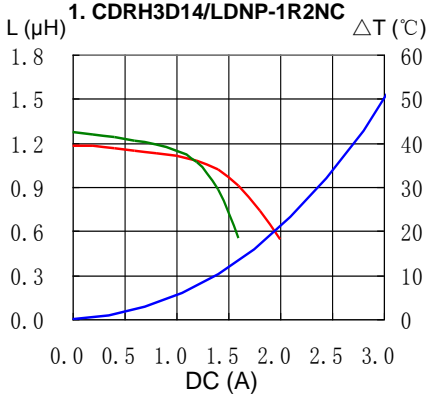

# SMD Power Inductor CDRH3D14/LD

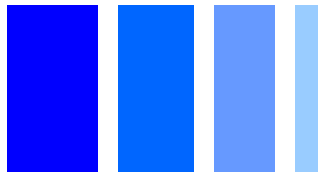

## Saturation Current & Temperature Rise Graph

— L (20°C) — L (105°C) —  $\Delta T$

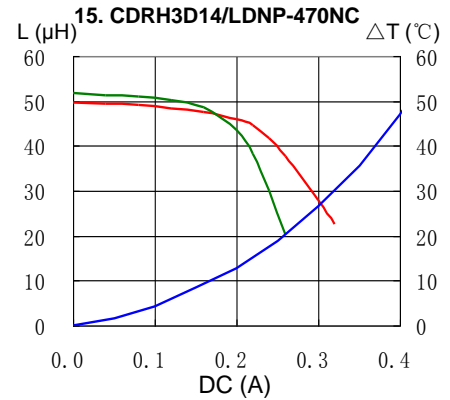
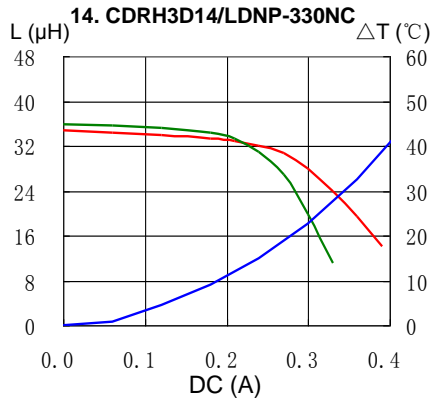
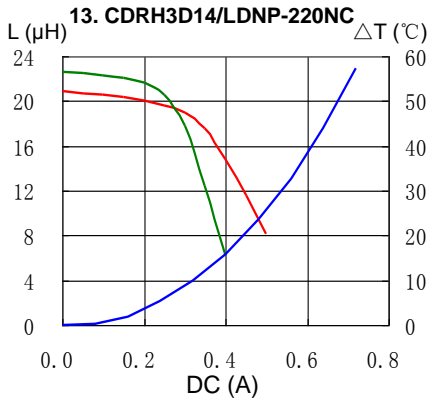

## Solder Reflow Condition

Heat Endurance

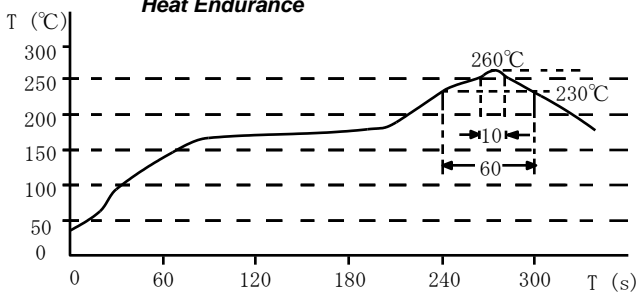

Temperature Chart

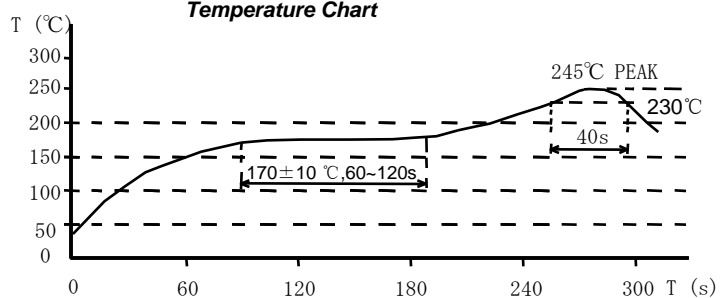

Please refer to the sales offices on our website - <http://www.sumida.com>

### Hong Kong

Tel. +852-2880-6781  
FAX. +852-2565-9600  
[sales@hk.sumida.com](mailto:sales@hk.sumida.com)

### Saitama(Japan)

Tel. +81-48-691-7300  
FAX. +81-48-691-7340  
[sales@jp.sumida.com](mailto:sales@jp.sumida.com)

### Chicago

Tel. +1-847-545-6700  
FAX. +1-847-545-6720  
[sales@us.sumida.com](mailto:sales@us.sumida.com)

### Shanghai

Tel. +86-21-5836-3299  
FAX. +86-21-5836-3266  
[shanghai.sales@cn.sumida.com](mailto:shanghai.sales@cn.sumida.com)

### Seoul

Tel. +82-2-6237-0777  
FAX. +82-2-6237-0778  
[sales@kr.sumida.com](mailto:sales@kr.sumida.com)

### Obernzell

Tel. +49-8591-937-0  
FAX. +49-8591-937-103  
[contact@eu.sumida.com](mailto:contact@eu.sumida.com)

### Shenzhen

Tel. +86-755-8291-0228  
FAX. +86-755-8291-0338  
[shenzhen.sales@cn.sumida.com](mailto:shenzhen.sales@cn.sumida.com)

### Singapore

Tel. +65-6296-3388  
FAX. +65-6841-4426  
[sales@sg.sumida.com](mailto:sales@sg.sumida.com)

### Neumarkt

Tel. +49-9181-4509-110  
FAX. +49-9181-4509-310  
[infocomp@eu.sumida.com](mailto:infocomp@eu.sumida.com)

### Taipei

Tel. +886-2-8751-2737  
FAX. +886-2-8751-2738  
[sales@tw.sumida.com](mailto:sales@tw.sumida.com)

### San Jose

Tel. +1-408-321-9660  
FAX. +1-408-321-9308  
[sales@us.sumida.com](mailto:sales@us.sumida.com)