

SMD Power Inductor CDRH3D14/LD

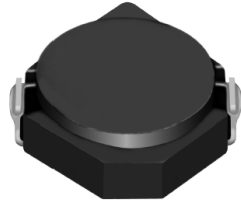

Description

- Ferrite drum core construction.
- Magnetically shielded.
- L × W × H: 4.0 × 4.0 × 1.5 mm Max.
- Product weight: 70mg(Ref.)
- Moisture Sensitivity Level: 1
- RoHS compliance.

Environmental Data

- Operating temperature range: -40°C ~ +105°C (including coil's self temperature rise)
- Storage temperature range: -40°C ~ +105°C
- Solder reflow temperature: 260 °C peak.

Packaging

- Carrier tape and reel packaging
- 7.0" diameter reel
- 1000pcs per reel

Applications

- Ideally used in Mobile phone, PDA, MP3, DSC/DVC, Portable DVD, etc as DC-DC converter inductors.

Dimension - [mm]

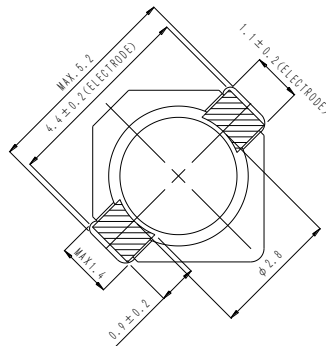
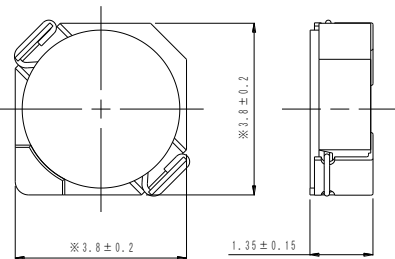

Land pattern and Schematics - [mm]

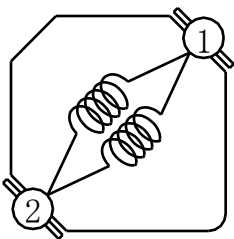
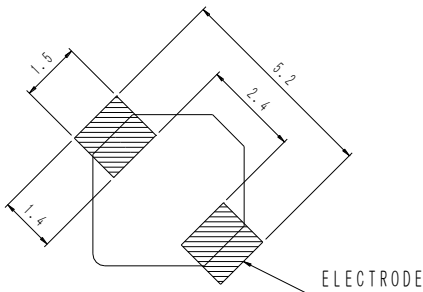

(1.2μH~3.0μH)

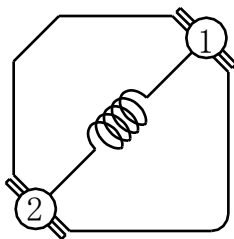

(3.9μH~47μH)



Electrical Characteristics

| Part Name | Stamp | Inductance (μH) [within] ※1 | D.C.R. (m Ω) Max. (Typ.) (at 20°C) | Saturation Current (A) ※2 | | Temperature Rise Current (A) ※3 |
|---------------------|-------|--|--|------------------------------|----------|---------------------------------------|
| | | | | at 20°C | at 100°C | |
| CDRH3D14/LDNP-1R2NC | A | 1.2 \pm 25% | 38 (30) | 1.50 | 1.28 | 2.70 |
| CDRH3D14/LDNP-1R5NC | B | 1.5 \pm 25% | 48 (38) | 1.35 | 1.05 | 2.40 |
| CDRH3D14/LDNP-2R0NC | C | 2.0 \pm 25% | 55 (44) | 1.15 | 0.95 | 2.20 |
| CDRH3D14/LDNP-2R5NC | D | 2.5 \pm 25% | 68 (54) | 1.05 | 0.80 | 1.90 |
| CDRH3D14/LDNP-3R0NC | E | 3.0 \pm 25% | 77 (62) | 0.95 | 0.75 | 1.60 |
| CDRH3D14/LDNP-3R9NC | F | 3.9 \pm 25% | 96 (77) | 0.80 | 0.65 | 1.50 |
| CDRH3D14/LDNP-4R5NC | G | 4.5 \pm 25% | 105 (84) | 0.75 | 0.60 | 1.45 |
| CDRH3D14/LDNP-5R6NC | H | 5.6 \pm 25% | 159 (127) | 0.70 | 0.55 | 1.10 |
| CDRH3D14/LDNP-6R8NC | I | 6.8 \pm 25% | 173 (138) | 0.60 | 0.50 | 1.05 |
| CDRH3D14/LDNP-100NC | K | 10 \pm 25% | 220 (176) | 0.50 | 0.38 | 1.00 |
| CDRH3D14/LDNP-120NC | L | 12 \pm 25% | 270 (216) | 0.45 | 0.35 | 0.80 |
| CDRH3D14/LDNP-150NC | M | 15 \pm 25% | 302 (242) | 0.40 | 0.30 | 0.75 |
| CDRH3D14/LDNP-220NC | O | 22 \pm 25% | 447 (358) | 0.35 | 0.27 | 0.60 |
| CDRH3D14/LDNP-330NC | Q | 33 \pm 25% | 848 (679) | 0.30 | 0.25 | 0.40 |
| CDRH3D14/LDNP-470NC | R | 47 \pm 25% | 1078 (863) | 0.25 | 0.20 | 0.35 |

※1. Inductance measuring condition: at 100kHz.

※2. Saturation current: The value of D.C. current when the inductance decreases to 65% of it's nominal value.

※3. Temperature rise current: The value of D.C. current when the temperature rise is $\Delta t=40^\circ\text{C}$ ($T_a=20^\circ\text{C}$).

SMD Power Inductor CDRH3D14/LD



Saturation Current & Temperature Rise Graph

— L (20°C) — L (105°C) — ΔT

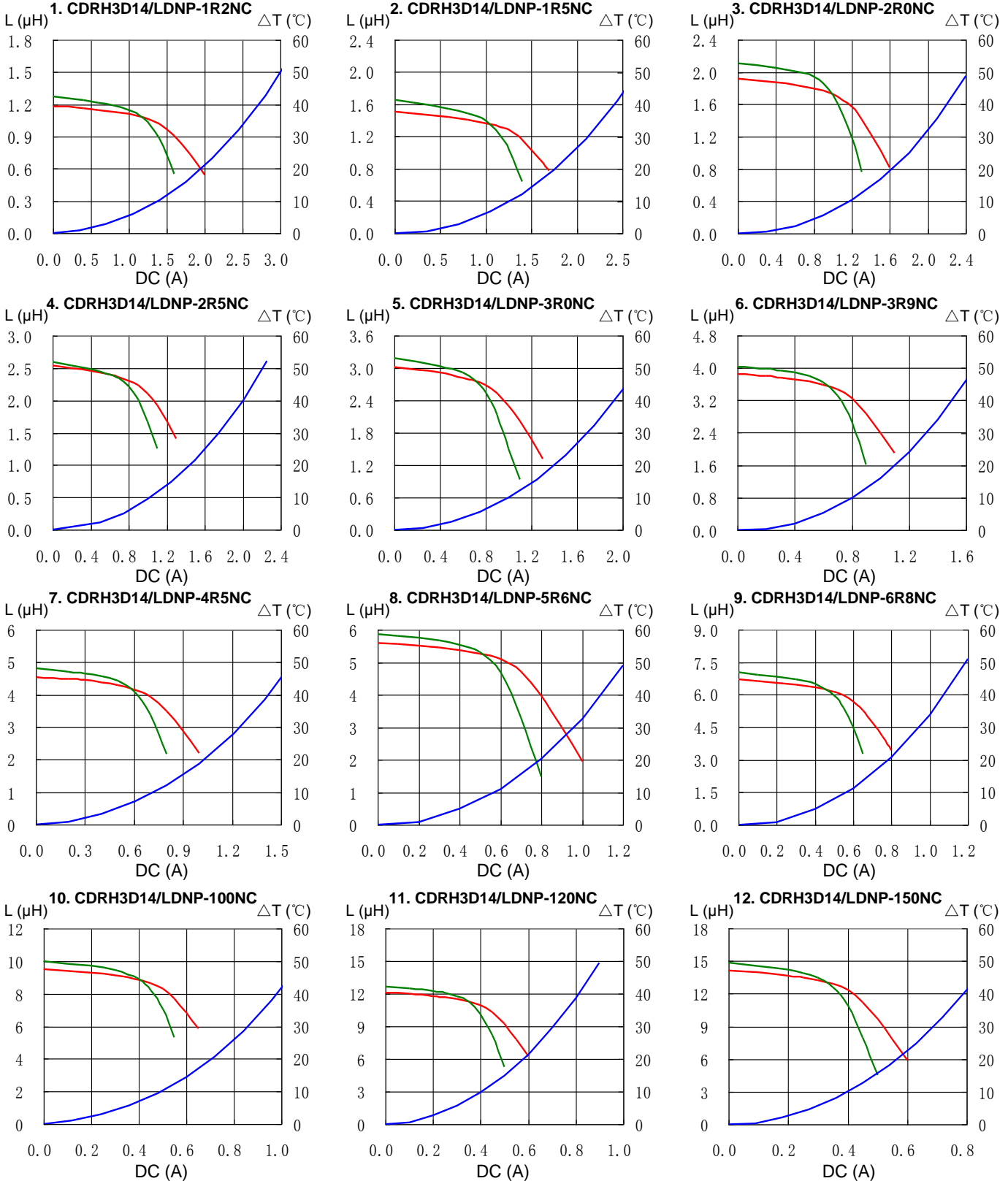

SMD Power Inductor CDRH3D14/LD



Saturation Current & Temperature Rise Graph

— L (20°C) — L (105°C) — ΔT

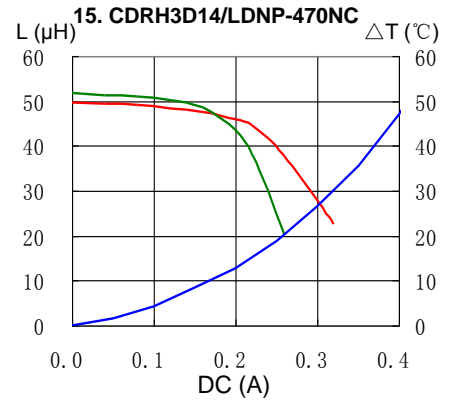
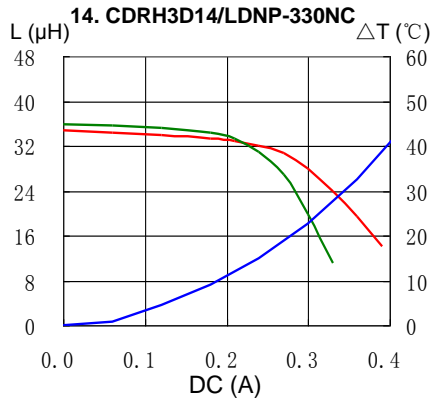
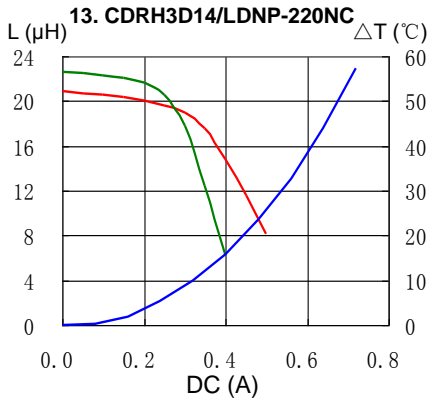

Solder Reflow Condition

Heat Endurance

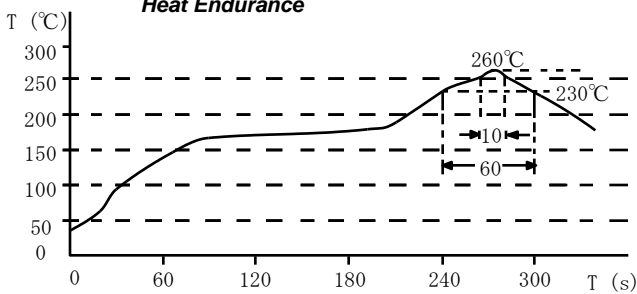

Temperature Chart

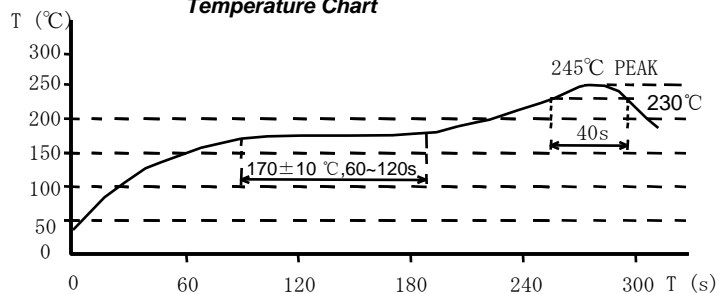

Please refer to the sales offices on our website - <http://www.sumida.com>

Hong Kong

Tel.+852-2880-6781
FAX.+852-2565-9600
sales@hk.sumida.com

Saitama(Japan)

Tel.+81-48-691-7300
FAX.+81-48-691-7340
sales@jp.sumida.com

Chicago

Tel.+1-847-545-6700
FAX. +1-847-545-6720
sales@us.sumida.com

Shanghai

Tel.+86-21-5836-3299
FAX.+86-21-5836-3266
shanghai.sales@cn.sumida.com

Seoul

Tel.+82-2-6237-0777
FAX.+82-2-6237-0778
sales@kr.sumida.com

Obernzell

Tel.+49-8591-937-0
FAX. +49-8591-937-103
contact@eu.sumida.com

Shenzhen

Tel.+86-755-8291-0228
FAX.+86-755-8291-0338
shenzhen.sales@cn.sumida.com

Singapore

Tel.+65-6296-3388
FAX.+65-6841-4426
sales@sg.sumida.com

Neumarkt

Tel.+49-9181-4509-110
FAX. +49-9181-4509-310
infocomp@eu.sumida.com

Taipei

Tel.+886-2-8751-2737
FAX.+886-2-8751-2738
sales@tw.sumida.com

San Jose

Tel.+1-408-321-9660
FAX.+1-408-321-9308
sales@us.sumida.com