

# SMD Power Inductor CDRH4D22

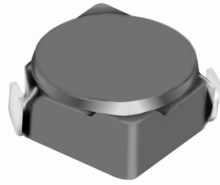

## Description

- Ferrite drum core construction.
- Magnetically shielded.
- L × W × H: 5.0 × 5.0 × 2.4 mm Max.
- Product weight: 0.2g(Ref.)
- Moisture Sensitivity Level: 1
- RoHS compliance.

## Environmental Data

- Operating temperature range: -40°C ~ +100°C (including coil's self temperature rise)
- Storage temperature range: -40°C ~ +100°C
- Solder reflow temperature: 260 °C peak.

## Packaging

- Carrier tape and reel packaging
- 12.9" diameter reel
- 2000pcs per reel

## Applications

- Ideally used in Mobile phone, PDA, MP3, HDD, DSC/DVC, Portable Computers, etc as DC-DC converter inductors.

## Dimension - [mm]

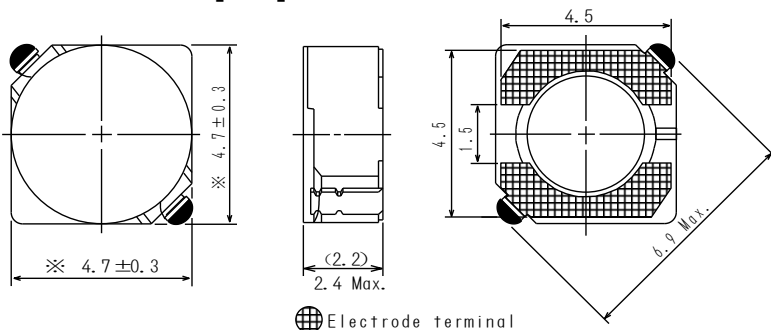

Electrode terminal

## Land pattern and Schematics - [mm]

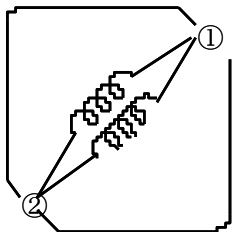
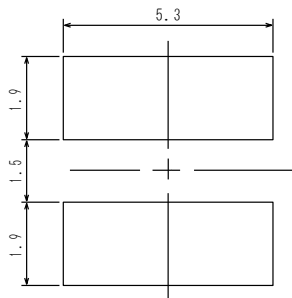

(1.5µH ~ 8.2µH)

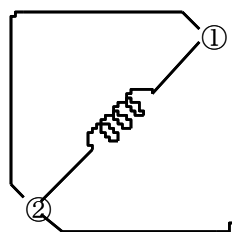

(10µH ~ 150µH)

# SMD Power Inductor

## CDRH4D22



### Electrical Characteristics

Part Name	Stamp	Inductance ( $\mu$ H) [within] ※1	D.C.R. (m $\Omega$ ) Max. (Typ.) (at 20°C)	Saturation Current (A) ※2		Temperature Rise Current (A) ※3
				at 20°C	at 100°C	
CDRH4D22NP-1R5NC	1R5	1.5 $\pm$ 30%	18.3(14.1)	2.00	1.60	4.20
CDRH4D22NP-1R8NC	1R8	1.8 $\pm$ 30%	21.6(16.6)	1.90	1.50	3.70
CDRH4D22NP-2R3NC	2R3	2.3 $\pm$ 30%	25.4(19.5)	1.80	1.40	3.60
CDRH4D22NP-3R3NC	3R3	3.3 $\pm$ 30%	35.1(27.0)	1.40	1.10	3.07
CDRH4D22NP-3R9NC	3R9	3.9 $\pm$ 30%	40.2(30.9)	1.30	1.00	3.04
CDRH4D22NP-4R7NC	4R7	4.7 $\pm$ 30%	55.9(43.0)	1.10	0.90	2.08
CDRH4D22NP-5R6NC	5R6	5.6 $\pm$ 30%	62.0(47.7)	1.05	0.85	2.05
CDRH4D22NP-6R8NC	6R8	6.8 $\pm$ 30%	88.0(67.7)	1.00	0.75	1.95
CDRH4D22NP-8R2NC	8R2	8.2 $\pm$ 30%	96.5(74.2)	0.90	0.65	1.85
CDRH4D22NP-100NC	100	10 $\pm$ 30%	102.4(78.8)	0.80	0.60	1.82
CDRH4D22NP-120NC	120	12 $\pm$ 30%	110.4(84.9)	0.75	0.55	1.80
CDRH4D22NP-150NC	150	15 $\pm$ 30%	127.4(98.0)	0.68	0.50	1.59
CDRH4D22NP-180NC	180	18 $\pm$ 30%	168.7(129.8)	0.60	0.43	1.41
CDRH4D22NP-220NC	220	22 $\pm$ 30%	199.7(153.6)	0.54	0.41	1.32
CDRH4D22NP-270NC	270	27 $\pm$ 30%	282.5(217.3)	0.51	0.38	1.04
CDRH4D22NP-330NC	330	33 $\pm$ 30%	325.8(250.6)	0.48	0.35	1.02
CDRH4D22NP-390NC	390	39 $\pm$ 30%	451.2(347.1)	0.43	0.32	0.85
CDRH4D22NP-470NC	470	47 $\pm$ 30%	500.4(384.9)	0.38	0.30	0.82
CDRH4D22NP-560NC	560	56 $\pm$ 30%	555.4(427.2)	0.36	0.28	0.72
CDRH4D22NP-680NC	680	68 $\pm$ 30%	634.1(487.8)	0.33	0.25	0.67
CDRH4D22NP-820NC	820	82 $\pm$ 30%	794.6(608.9)	0.30	0.22	0.58
CDRH4D22NP-101NC	101	100 $\pm$ 30%	880(670)	0.25	0.20	0.55
CDRH4D22NP-121NC	121	120 $\pm$ 30%	1140(880)	0.23	0.18	0.52
CDRH4D22NP-151NC	151	150 $\pm$ 30%	1350(1040)	0.21	0.17	0.47

※1. Inductance measuring condition: at 100kHz.

※2. Saturation current: The value of D.C. current when the inductance decreases to 65% of it's nominal value.

※3. Temperature rise current: The value of D.C. current when the temperature rise is  $\Delta t=40^{\circ}\text{C}$  ( $T_a=20^{\circ}\text{C}$ ).

# SMD Power Inductor CDRH4D22



## Saturation Current & Temperature Rise Graph

— L (20°C) — L (105°C) —  $\Delta T$

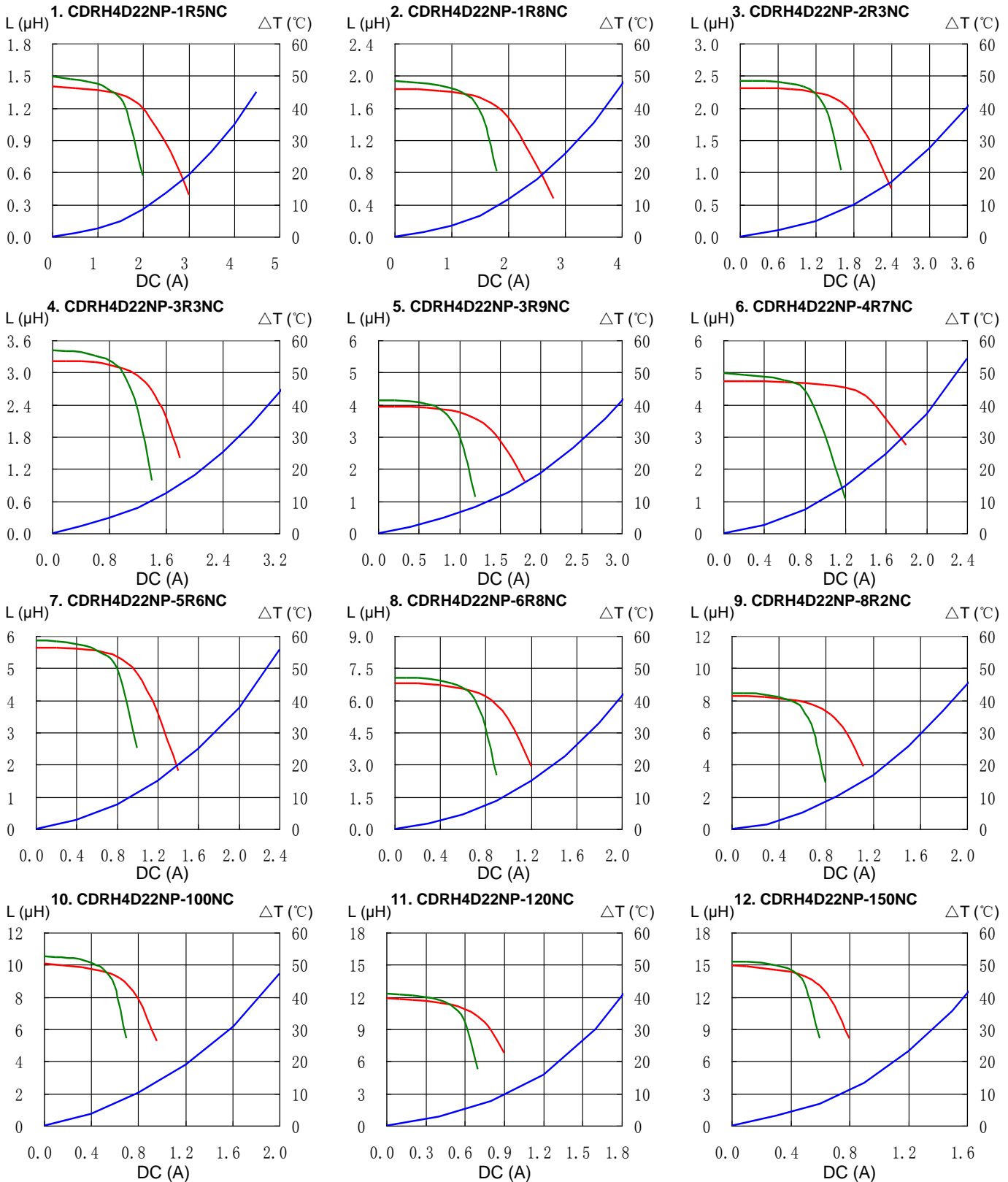

# SMD Power Inductor CDRH4D22



## Saturation Current & Temperature Rise Graph

— L (20°C) — L (105°C) —  $\Delta T$

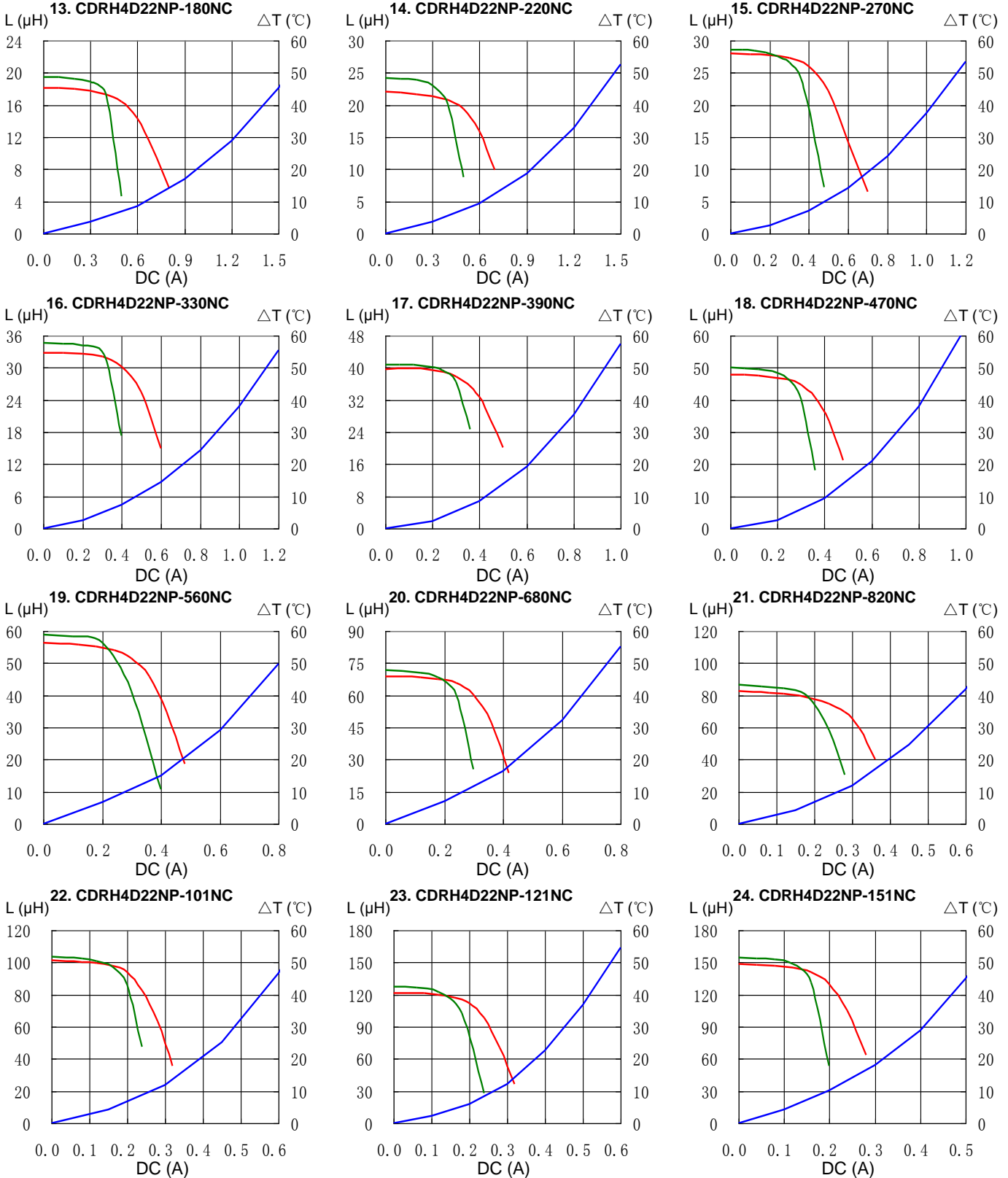

# SMD Power Inductor CDRH4D22



## Solder Reflow Condition

Heat Endurance

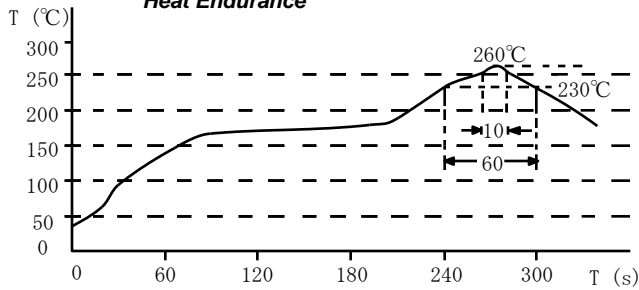

Temperature Chart

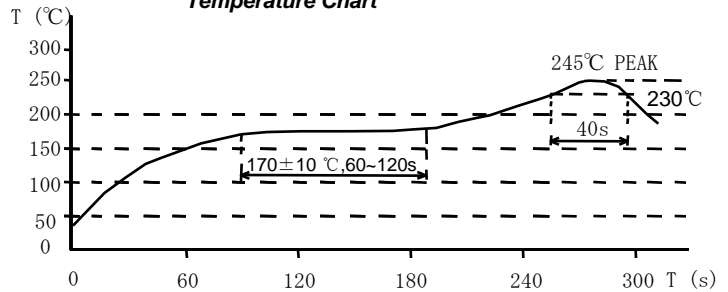

Please refer to the sales offices on our website - <http://www.sumida.com>

### Hong Kong

Tel.+852-2880-6781  
FAX.+852-2565-9600  
[sales@hk.sumida.com](mailto:sales@hk.sumida.com)

### Saitama(Japan)

Tel.+81-48-691-7300  
FAX.+81-48-691-7340  
[sales@jp.sumida.com](mailto:sales@jp.sumida.com)

### Chicago

Tel.+1-847-545-6700  
FAX. +1-847-545-6720  
[sales@us.sumida.com](mailto:sales@us.sumida.com)

### Shanghai

Tel.+86-21-5836-3299  
FAX.+86-21-5836-3266  
[shanghai.sales@cn.sumida.com](mailto:shanghai.sales@cn.sumida.com)

### Seoul

Tel.+82-2-6237-0777  
FAX.+82-2-6237-0778  
[sales@kr.sumida.com](mailto:sales@kr.sumida.com)

### Obernzell

Tel.+49-8591-937-0  
FAX. +49-8591-937-103  
[contact@eu.sumida.com](mailto:contact@eu.sumida.com)

### Shenzhen

Tel.+86-755-8291-0228  
FAX.+86-755-8291-0338  
[shenzhen.sales@cn.sumida.com](mailto:shenzhen.sales@cn.sumida.com)

### Singapore

Tel.+65-6296-3388  
FAX.+65-6841-4426  
[sales@sg.sumida.com](mailto:sales@sg.sumida.com)

### Neumarkt

Tel.+49-9181-4509-110  
FAX. +49-9181-4509-310  
[infocomp@eu.sumida.com](mailto:infocomp@eu.sumida.com)

### Taipei

Tel.+886-2-8751-2737  
FAX.+886-2-8751-2738  
[sales@tw.sumida.com](mailto:sales@tw.sumida.com)

### San Jose

Tel.+1-408-321-9660  
FAX.+1-408-321-9308  
[sales@us.sumida.com](mailto:sales@us.sumida.com)