

SMD Power Inductor CDRH4D22

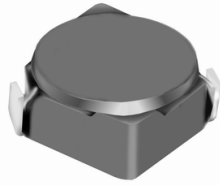

Description

- Ferrite drum core construction.
- Magnetically shielded.
- L × W × H: 5.0 × 5.0 × 2.4 mm Max.
- Product weight: 0.2g(Ref.)
- Moisture Sensitivity Level: 1
- RoHS compliance.

Environmental Data

- Operating temperature range: -40°C ~ +100°C (including coil's self temperature rise)
- Storage temperature range: -40°C ~ +100°C
- Solder reflow temperature: 260 °C peak.

Packaging

- Carrier tape and reel packaging
- 12.9" diameter reel
- 2000pcs per reel

Applications

- Ideally used in Mobile phone, PDA, MP3, HDD, DSC/DVC, Portable Computers, etc as DC-DC converter inductors.

Dimension - [mm]

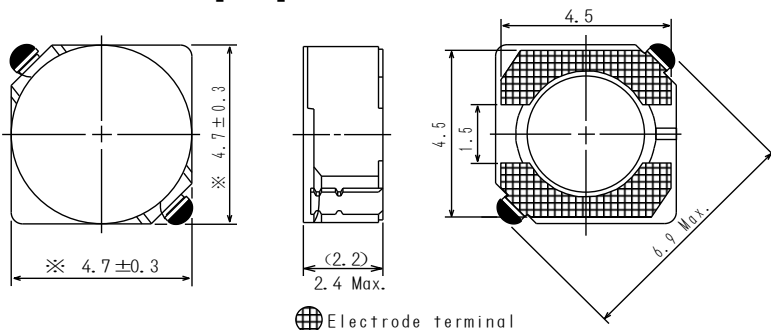

⊕ Electrode terminal

Land pattern and Schematics - [mm]

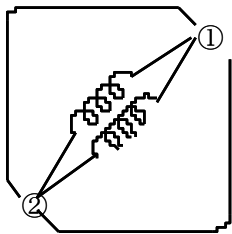
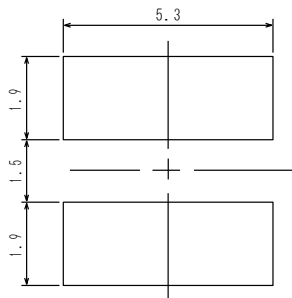

(1.5µH ~ 8.2µH)

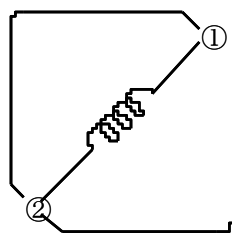

(10µH ~ 150µH)

SMD Power Inductor

CDRH4D22



Electrical Characteristics

| Part Name | Stamp | Inductance (μ H) [within] ※1 | D.C.R. (m Ω) Max. (Typ.) (at 20°C) | Saturation Current (A) ※2 | | Temperature Rise Current (A) ※3 |
|------------------|-------|---|--|------------------------------|----------|---------------------------------------|
| | | | | at 20°C | at 100°C | |
| CDRH4D22NP-1R5NC | 1R5 | 1.5 \pm 30% | 18.3(14.1) | 2.00 | 1.60 | 4.20 |
| CDRH4D22NP-1R8NC | 1R8 | 1.8 \pm 30% | 21.6(16.6) | 1.90 | 1.50 | 3.70 |
| CDRH4D22NP-2R3NC | 2R3 | 2.3 \pm 30% | 25.4(19.5) | 1.80 | 1.40 | 3.60 |
| CDRH4D22NP-3R3NC | 3R3 | 3.3 \pm 30% | 35.1(27.0) | 1.40 | 1.10 | 3.07 |
| CDRH4D22NP-3R9NC | 3R9 | 3.9 \pm 30% | 40.2(30.9) | 1.30 | 1.00 | 3.04 |
| CDRH4D22NP-4R7NC | 4R7 | 4.7 \pm 30% | 55.9(43.0) | 1.10 | 0.90 | 2.08 |
| CDRH4D22NP-5R6NC | 5R6 | 5.6 \pm 30% | 62.0(47.7) | 1.05 | 0.85 | 2.05 |
| CDRH4D22NP-6R8NC | 6R8 | 6.8 \pm 30% | 88.0(67.7) | 1.00 | 0.75 | 1.95 |
| CDRH4D22NP-8R2NC | 8R2 | 8.2 \pm 30% | 96.5(74.2) | 0.90 | 0.65 | 1.85 |
| CDRH4D22NP-100NC | 100 | 10 \pm 30% | 102.4(78.8) | 0.80 | 0.60 | 1.82 |
| CDRH4D22NP-120NC | 120 | 12 \pm 30% | 110.4(84.9) | 0.75 | 0.55 | 1.80 |
| CDRH4D22NP-150NC | 150 | 15 \pm 30% | 127.4(98.0) | 0.68 | 0.50 | 1.59 |
| CDRH4D22NP-180NC | 180 | 18 \pm 30% | 168.7(129.8) | 0.60 | 0.43 | 1.41 |
| CDRH4D22NP-220NC | 220 | 22 \pm 30% | 199.7(153.6) | 0.54 | 0.41 | 1.32 |
| CDRH4D22NP-270NC | 270 | 27 \pm 30% | 282.5(217.3) | 0.51 | 0.38 | 1.04 |
| CDRH4D22NP-330NC | 330 | 33 \pm 30% | 325.8(250.6) | 0.48 | 0.35 | 1.02 |
| CDRH4D22NP-390NC | 390 | 39 \pm 30% | 451.2(347.1) | 0.43 | 0.32 | 0.85 |
| CDRH4D22NP-470NC | 470 | 47 \pm 30% | 500.4(384.9) | 0.38 | 0.30 | 0.82 |
| CDRH4D22NP-560NC | 560 | 56 \pm 30% | 555.4(427.2) | 0.36 | 0.28 | 0.72 |
| CDRH4D22NP-680NC | 680 | 68 \pm 30% | 634.1(487.8) | 0.33 | 0.25 | 0.67 |
| CDRH4D22NP-820NC | 820 | 82 \pm 30% | 794.6(608.9) | 0.30 | 0.22 | 0.58 |
| CDRH4D22NP-101NC | 101 | 100 \pm 30% | 880(670) | 0.25 | 0.20 | 0.55 |
| CDRH4D22NP-121NC | 121 | 120 \pm 30% | 1140(880) | 0.23 | 0.18 | 0.52 |
| CDRH4D22NP-151NC | 151 | 150 \pm 30% | 1350(1040) | 0.21 | 0.17 | 0.47 |

※1. Inductance measuring condition: at 100kHz.

※2. Saturation current: The value of D.C. current when the inductance decreases to 65% of it's nominal value.

※3. Temperature rise current: The value of D.C. current when the temperature rise is $\Delta t=40^{\circ}\text{C}$ ($T_a=20^{\circ}\text{C}$).

SMD Power Inductor CDRH4D22



Saturation Current & Temperature Rise Graph

— L (20°C) — L (105°C) — ΔT

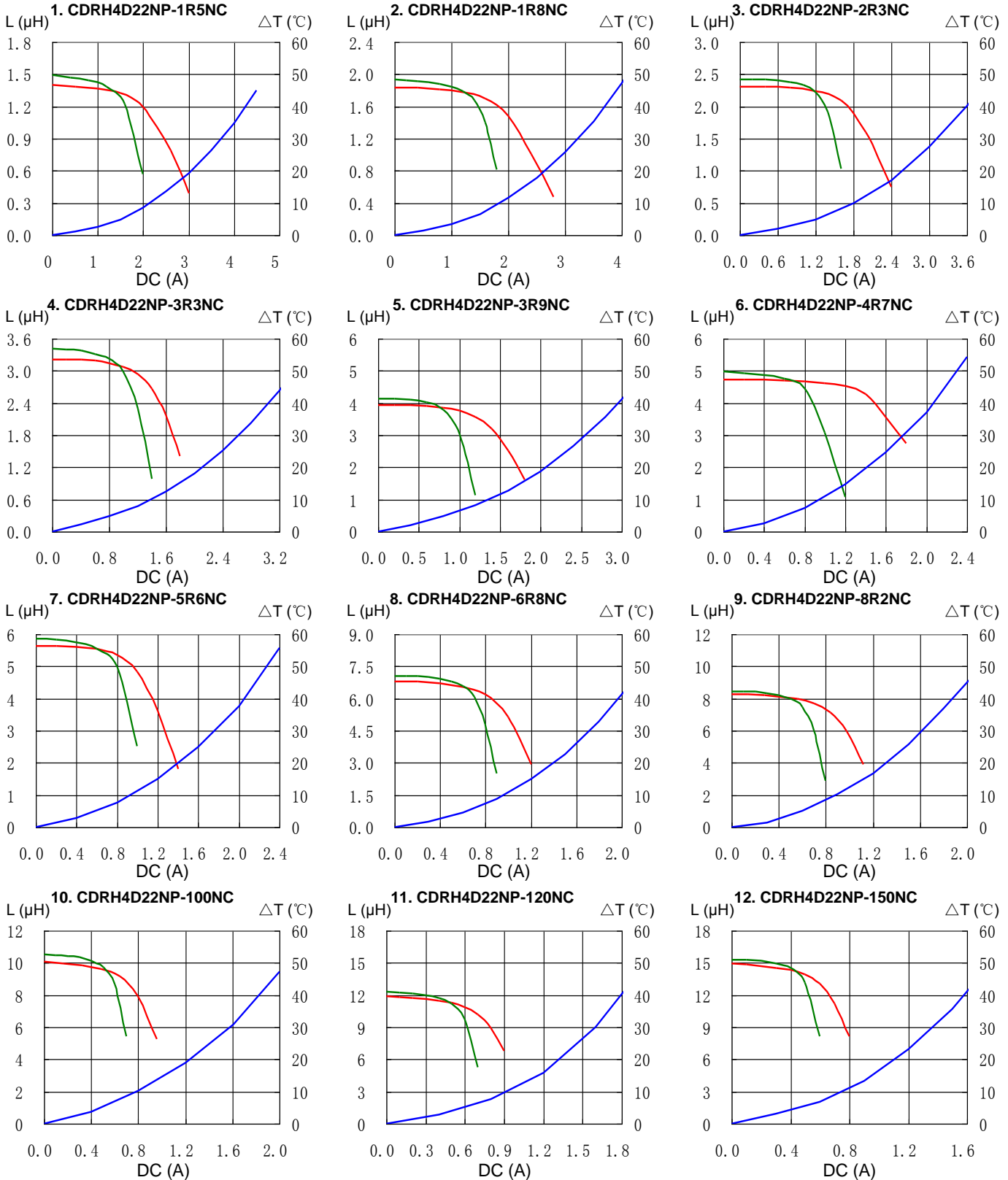

SMD Power Inductor CDRH4D22



Saturation Current & Temperature Rise Graph

— L (20°C) — L (105°C) — ΔT

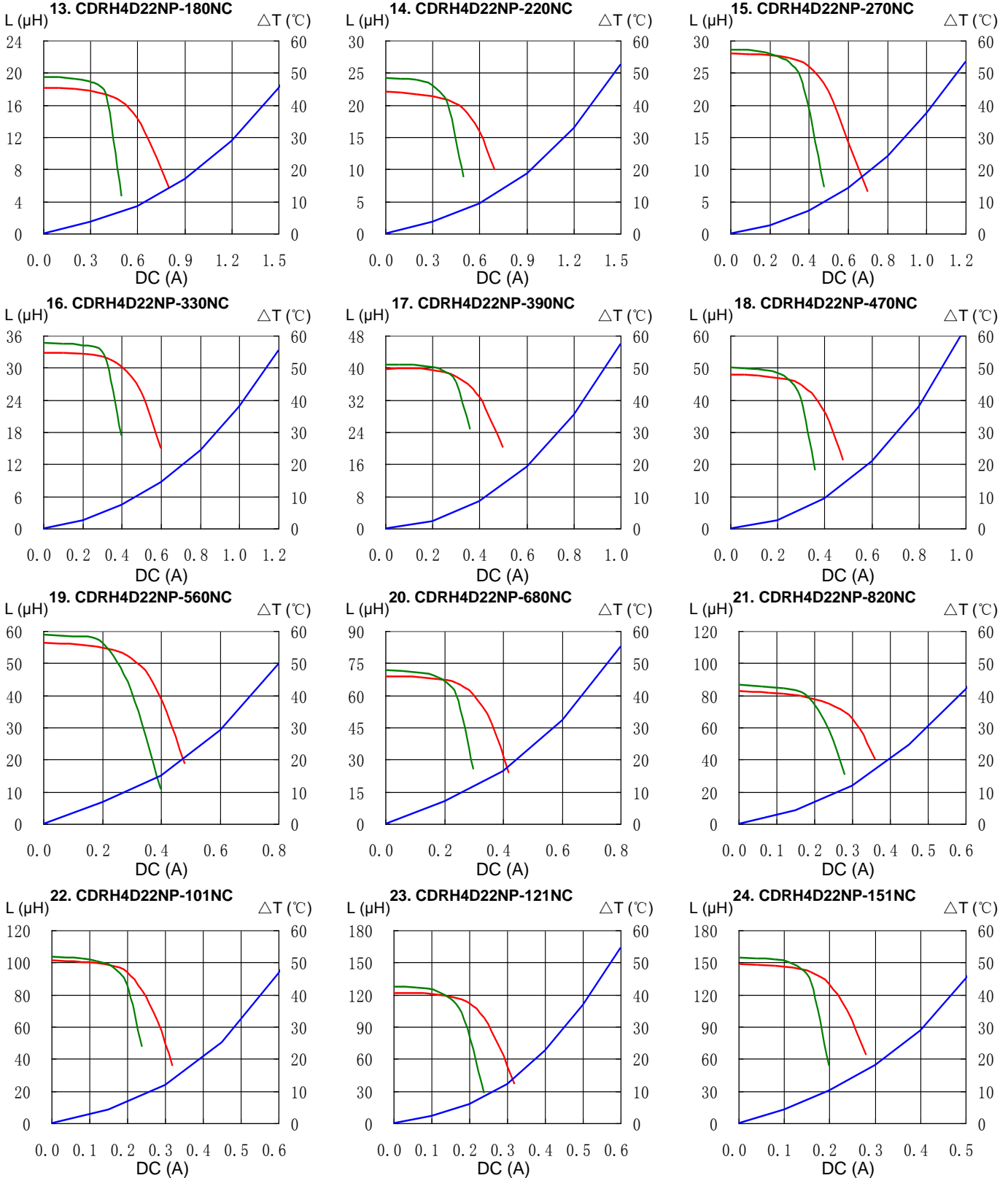

SMD Power Inductor CDRH4D22



Solder Reflow Condition

Heat Endurance

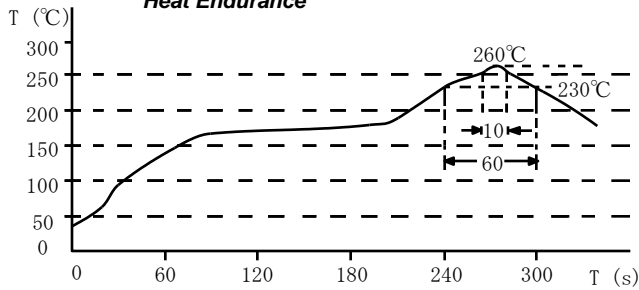

Temperature Chart

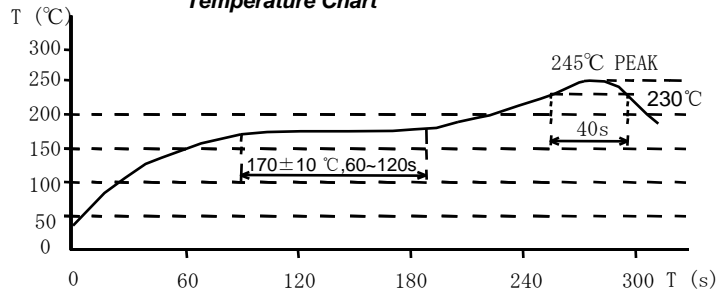

Please refer to the sales offices on our website - <http://www.sumida.com>

Hong Kong

Tel.+852-2880-6781
FAX.+852-2565-9600
sales@hk.sumida.com

Saitama(Japan)

Tel.+81-48-691-7300
FAX.+81-48-691-7340
sales@jp.sumida.com

Chicago

Tel.+1-847-545-6700
FAX. +1-847-545-6720
sales@us.sumida.com

Shanghai

Tel.+86-21-5836-3299
FAX.+86-21-5836-3266
shanghai.sales@cn.sumida.com

Seoul

Tel.+82-2-6237-0777
FAX.+82-2-6237-0778
sales@kr.sumida.com

Obernzell

Tel.+49-8591-937-0
FAX. +49-8591-937-103
contact@eu.sumida.com

Shenzhen

Tel.+86-755-8291-0228
FAX.+86-755-8291-0338
shenzhen.sales@cn.sumida.com

Singapore

Tel.+65-6296-3388
FAX.+65-6841-4426
sales@sg.sumida.com

Neumarkt

Tel.+49-9181-4509-110
FAX. +49-9181-4509-310
infocomp@eu.sumida.com

Taipei

Tel.+886-2-8751-2737
FAX.+886-2-8751-2738
sales@tw.sumida.com

San Jose

Tel.+1-408-321-9660
FAX.+1-408-321-9308
sales@us.sumida.com