

# SMD Power Inductor CDRH4D28



## Description

- Ferrite drum core construction.
- Magnetically shielded.
- L × W × H: 5.0 × 5.0 × 3.0 mm Max.
- Product weight: 0.2g(Ref.)
- Moisture Sensitivity Level: 1
- RoHS compliance.

## Environmental Data

- Operating temperature range: -40°C ~ +100°C (including coil's self temperature rise)
- Storage temperature range: -40°C ~ +100°C
- Solder reflow temperature: 260 °C peak.

## Packaging

- Carrier tape and reel packaging
- 12.9" diameter reel
- 2000pcs per reel

## Applications

- Ideally used in Mobile phone, PDA, MP3, HDD, DSC/DVC, Note book PC, etc as DC-DC converter inductors.

## Dimension - [mm]

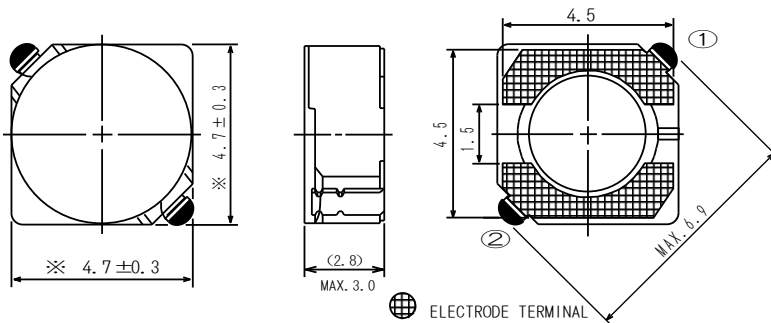

ELECTRODE TERMINAL

## Land pattern and Schematics - [mm]

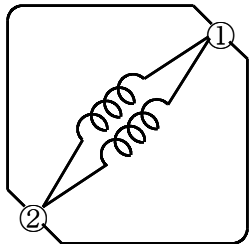
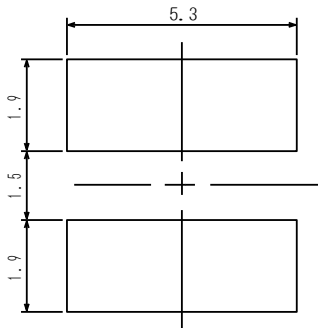

( 1.2μH ~ 8.2μH )

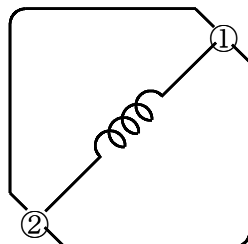

( 10μH ~ 180μH )

# SMD Power Inductor

## CDRH4D28



### Electrical Characteristics

Part No.	Stamp	Inductance ( $\mu\text{H}$ ) [ within ] ※1	D.C.R.( $\Omega$ ) Max. (Typ.) (at 20°C)	Rated Current (A) ※2
CDRH4D28NP-1R2NC	1R2	1.2 $\pm$ 30%	23.6m(17.5m)	2.56
CDRH4D28NP-1R8NC	1R8	1.8 $\pm$ 30%	27.5m(20.4m)	2.20
CDRH4D28NP-2R2NC	2R2	2.2 $\pm$ 30%	31.3m(23.2m)	2.04
CDRH4D28NP-2R7NC	2R7	2.7 $\pm$ 30%	43.3m(32.1m)	1.60
CDRH4D28NP-3R3NC	3R3	3.3 $\pm$ 30%	49.2m(36.4m)	1.57
CDRH4D28NP-3R9NC	3R9	3.9 $\pm$ 30%	64.8m(48.0m)	1.44
CDRH4D28NP-4R7NC	4R7	4.7 $\pm$ 30%	72.0m(53.3m)	1.32
CDRH4D28NP-5R6NC	5R6	5.6 $\pm$ 30%	100.9m(74.7m)	1.17
CDRH4D28NP-6R8NC	6R8	6.8 $\pm$ 30%	108.9m(80.7m)	1.12
CDRH4D28NP-8R2NC	8R2	8.2 $\pm$ 30%	117.5m(87.0m)	1.04
CDRH4D28NP-100NC	100	10 $\pm$ 30%	128.3m(95.0m)	1.00
CDRH4D28NP-120NC	120	12 $\pm$ 30%	131.6m(97.5m)	0.84
CDRH4D28NP-150NC	150	15 $\pm$ 30%	149.0m(110.4m)	0.76
CDRH4D28NP-180NC	180	18 $\pm$ 30%	166.0m(123.0m)	0.72
CDRH4D28NP-220NC	220	22 $\pm$ 30%	235.0m(174.5m)	0.70
CDRH4D28NP-270NC	270	27 $\pm$ 30%	261.0m(193.3m)	0.58
CDRH4D28NP-330NC	330	33 $\pm$ 30%	331.3m(254.8m)	0.56
CDRH4D28NP-390NC	390	39 $\pm$ 30%	383.7m(284.2m)	0.50
CDRH4D28NP-470NC	470	47 $\pm$ 30%	587.0m(435.0m)	0.48
CDRH4D28NP-560NC	560	56 $\pm$ 30%	624.5m(462.6m)	0.41
CDRH4D28NP-680NC	680	68 $\pm$ 30%	699.0m(517.8m)	0.35
CDRH4D28NP-820NC	820	82 $\pm$ 30%	914.8m(677.6m)	0.32
CDRH4D28NP-101NC	101	100 $\pm$ 30%	1.02(765.8m)	0.29
CDRH4D28NP-121NC	121	120 $\pm$ 30%	1.27(976.8m)	0.27
CDRH4D28NP-151NC	151	150 $\pm$ 30%	1.35(1.08)	0.24
CDRH4D28NP-181NC	181	180 $\pm$ 30%	1.54(1.23)	0.22

※1. Inductance measuring condition: at 100kHz.

※2. Rated current: The DC current at which the inductance decreases to 65% of its nominal value or when  $\Delta t=40^\circ\text{C}$ , whichever is lower ( $T_a=20^\circ\text{C}$ ).

# SMD Power Inductor CDRH4D28



## Saturation Current & Temperature Rise Graph

— L (20°C) — L (100°C) —  $\Delta T$

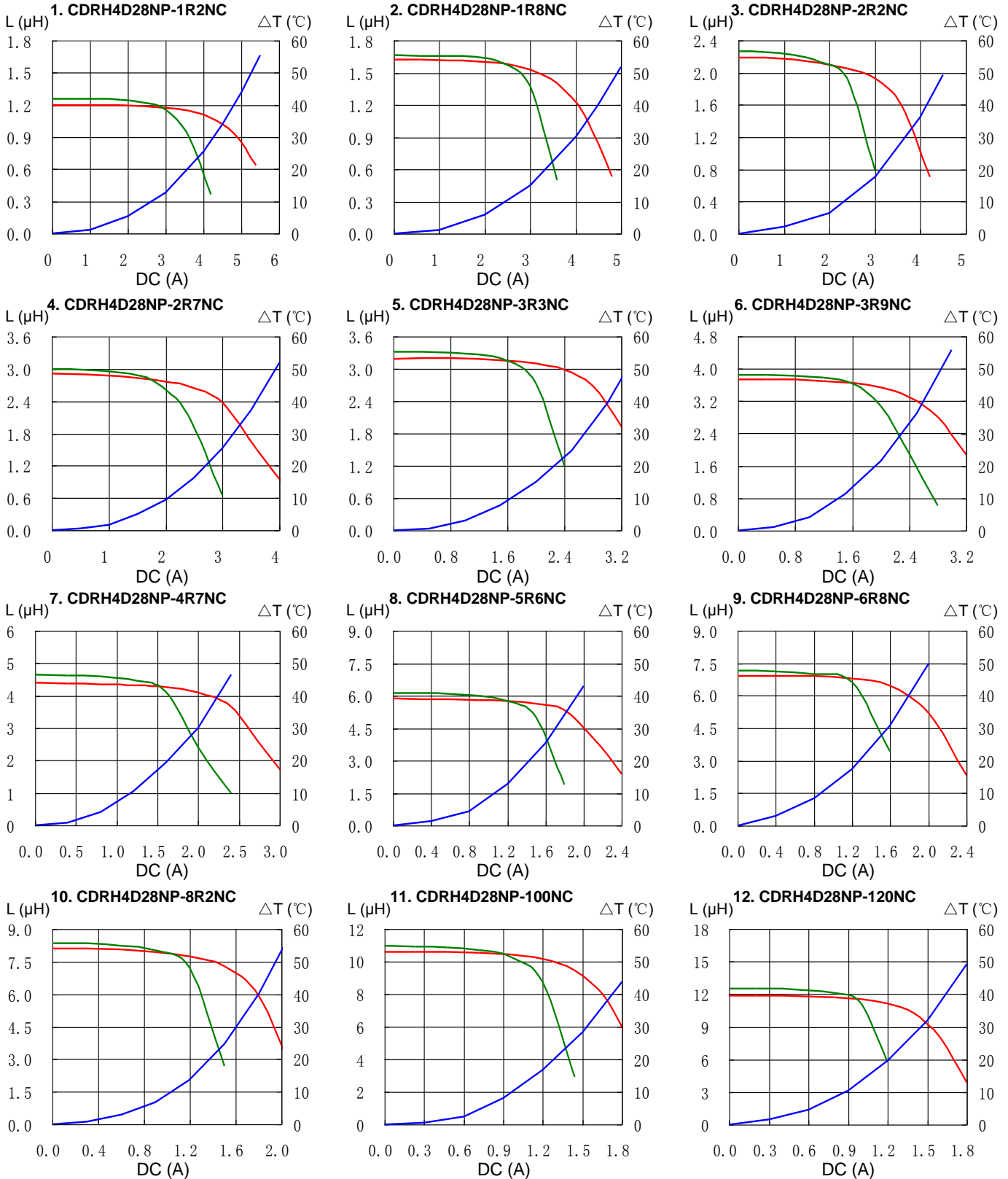

# SMD Power Inductor CDRH4D28



## Saturation Current & Temperature Rise Graph

— L (20°C) — L (100°C) —  $\Delta T$

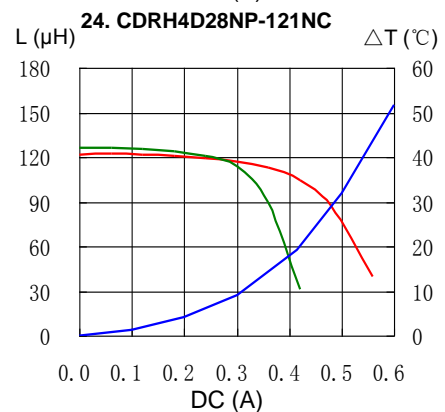
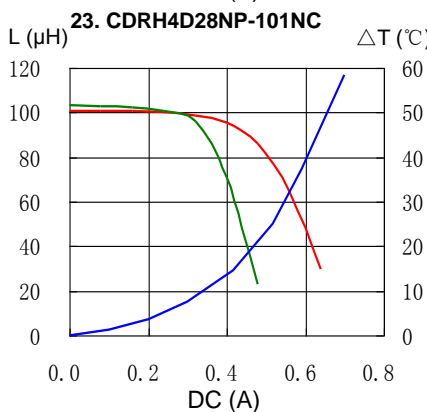
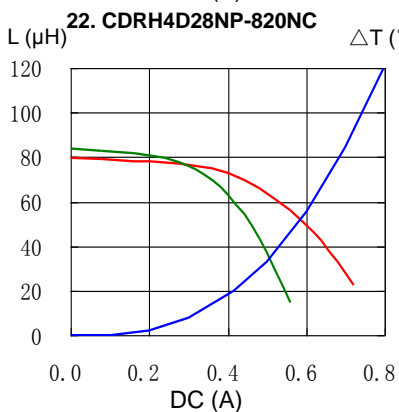
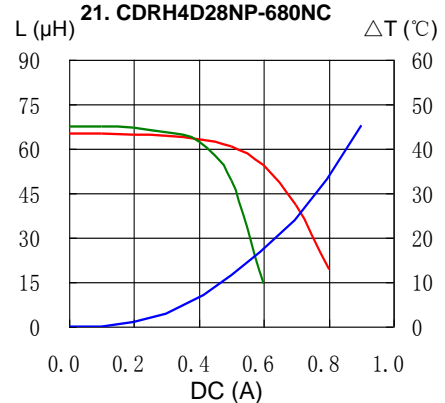
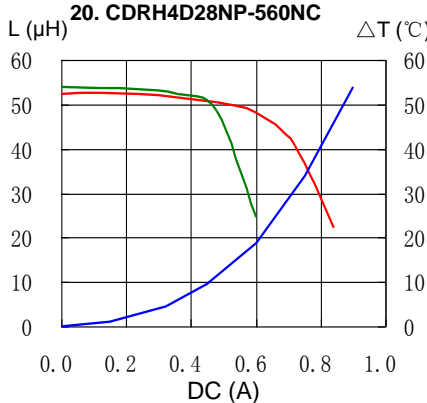
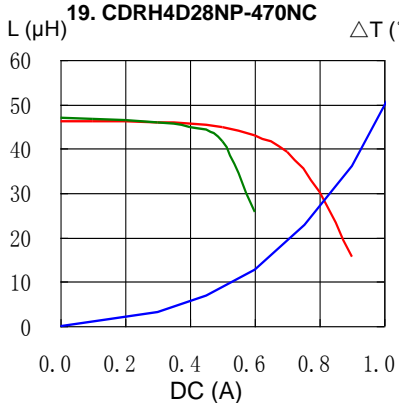
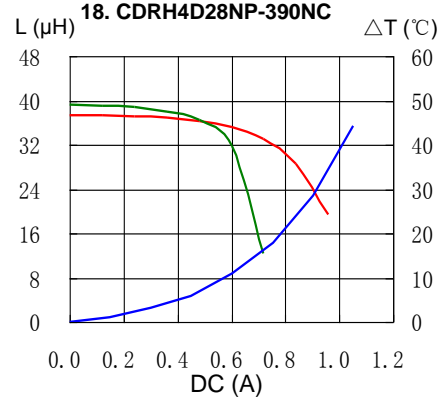
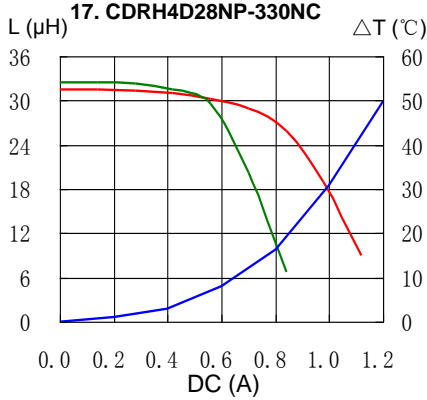
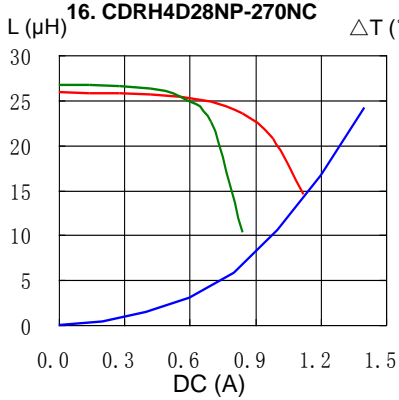
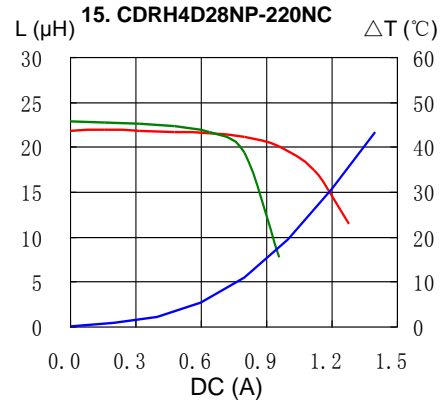
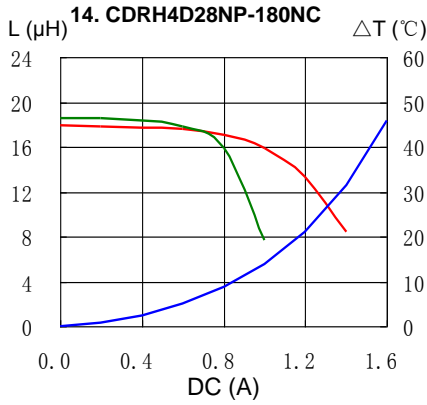
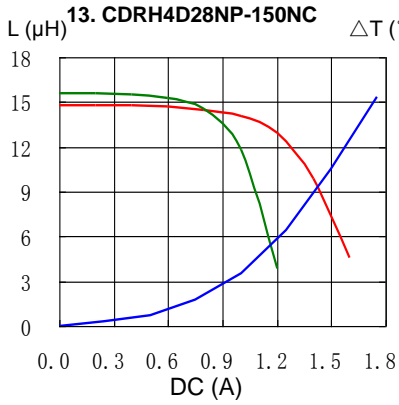

# SMD Power Inductor CDRH4D28



## Saturation Current & Temperature Rise Graph

— L (20°C) — L (100°C) —  $\Delta T$

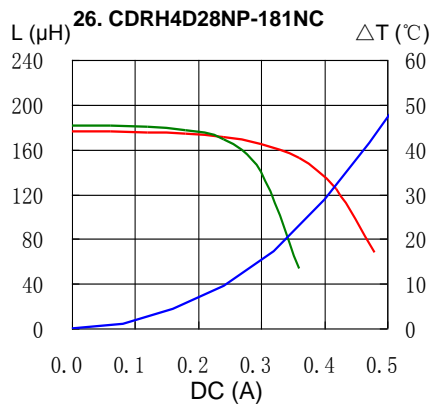
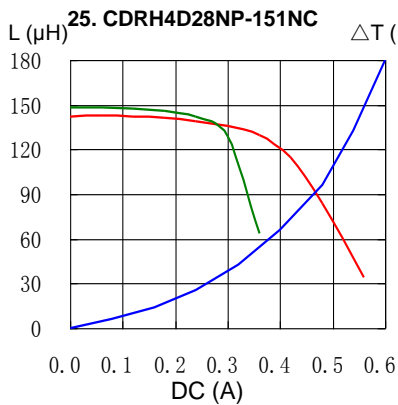

## Solder Reflow Condition

Heat Endurance

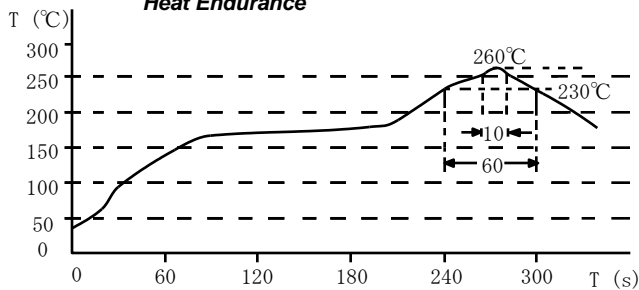

Temperature Chart

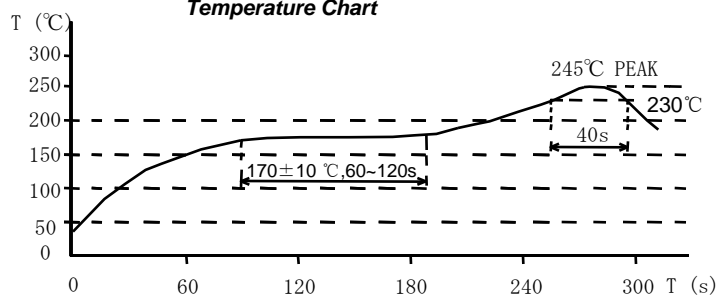

Please refer to the sales offices on our website - <http://www.sumida.com>

### Hong Kong

Tel.+852-2880-6781  
FAX.+852-2565-9600  
[sales@hk.sumida.com](mailto:sales@hk.sumida.com)

### Saitama(Japan)

Tel.+81-48-691-7300  
FAX.+81-48-691-7340  
[sales@jp.sumida.com](mailto:sales@jp.sumida.com)

### Chicago

Tel.+1-847-545-6700  
FAX. +1-847-545-6720  
[sales@us.sumida.com](mailto:sales@us.sumida.com)

### Shanghai

Tel.+86-21-5836-3299  
FAX.+86-21-5836-3266  
[shanghai.sales@cn.sumida.com](mailto:shanghai.sales@cn.sumida.com)

### Seoul

Tel.+82-2-6237-0777  
FAX.+82-2-6237-0778  
[sales@kr.sumida.com](mailto:sales@kr.sumida.com)

### Obernzell

Tel.+49-8591-937-0  
FAX. +49-8591-937-103  
[contact@eu.sumida.com](mailto:contact@eu.sumida.com)

### Shenzhen

Tel.+86-755-8291-0228  
FAX.+86-755-8291-0338  
[shenzhen.sales@cn.sumida.com](mailto:shenzhen.sales@cn.sumida.com)

### Singapore

Tel.+65-6296-3388  
FAX.+65-6841-4426  
[sales@sg.sumida.com](mailto:sales@sg.sumida.com)

### Neumarkt

Tel.+49-9181-4509-110  
FAX. +49-9181-4509-310  
[infocomp@eu.sumida.com](mailto:infocomp@eu.sumida.com)

### Taipei

Tel.+886-2-8751-2737  
FAX.+886-2-8751-2738  
[sales@tw.sumida.com](mailto:sales@tw.sumida.com)

### San Jose

Tel.+1-408-321-9660  
FAX.+1-408-321-9308  
[sales@us.sumida.com](mailto:sales@us.sumida.com)